



# ELIO

YABU PUSHELBERG





# COLLECTION EXTENSIONS

The 2025 ELIO collection captures the essence of outdoor lounging with the introduction of new sofas, daybeds, and poufs. Expanding on the softly rounded silhouette of the original series, the low profiles and graceful curves evoke the beauty of water-smoothed pebbles. Every element is crafted to prioritize comfort and versatility, blending organic shapes with modern sophistication. Modular back and armrest options invite personalized compositions, ensuring each creation is distinctly your own.

# TRIBÙ



1 SEATER



2 SEATER  
FULL BACKREST



3 SEATER  
FULL BACKREST



DAYBED  
FULL BACKREST



1 SEATER POUF



2 SEATER POUF



3 SEATER POUF



DAYBED POUF



2 SEATER  
MERIDIENNE RIGHT



3 SEATER  
MERIDIENNE RIGHT



DAYBED  
MERIDIENNE RIGHT



2 SEATER  
MERIDIENNE LEFT



3 SEATER  
MERIDIENNE LEFT



DAYBED  
MERIDIENNE LEFT



2 SEATER  
EXTENSION



DAYBED  
EXTENSION

## FRAME

T-TEAK



## WEAVE

10-LINEN



# AMANU

YABU PUSHELBERG



# COLLECTION ADDITIONS

Blending the beauty and durability of teak with the sophisticated charm of woven Canax® sling seats, AMANU introduces new lounging additions. Central to the ensemble is the signature three-seater sofa with generously spacious seating. The collection's new daybed offers a refined retreat, featuring a delicate floating effect reminiscent of the collection's dining chairs. Completing the new ensemble is a selection of variously shaped coffee tables, each imbued with the distinctive look of the collection's dining table, fitting any outdoor setting.



# TRIBÙ



3 SEATER SOFA



DAYBED



LOW TABLE  
ROUND 90  
H 28 / 35 / 42 CM



LOW TABLE  
ROUND 125  
H 28 / 35 / 42 CM



LOW TABLE  
RECTANGULAR 155  
H 28 / 35 / 42 CM



C-TABLE

## FRAME

T-TEAK

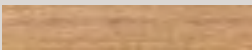

## WEAVE

10-LINEN



## TABLE TOP

C15-SABBIA



C80-SCIISTO





# DUNES

YABU PUSHELBERG

# TABLE ADDITIONS

The timeless DUNES table, with its gently domed sculptural base and smooth circular top, welcomes a 2025 addition. The new low table features not one but three of its signature bases in varying sizes, supporting an organically shaped, pebble-inspired top. As unpretentious as the original monobase, this low table complements any outdoor setting. Available in solid teak for warmth, a terrazzo-inspired finish, or with contrasting materials, making a design statement, it allows you to customise outdoor spaces just as you envisioned.

# TRIBÙ



---

SIDE TABLE SMALL  
W 81 CM  
L 105 CM  
H 32 CM



---

SIDE TABLE LARGE  
W 107 CM  
L 140 CM  
H 32 CM

FRAME

T-TEAK





# LUCCA

STUDIO SEGERS



# NEW COLLECTION

At first glance, the new LUCCA collection feels instantly familiar, making it easy to love. Then dive deep, and subtle design details emerge. The armchair and lounge chair feature graceful silhouettes inspired by Japanese calligraphy, while the armrests and woven textile bands pay tribute to Southern braiding techniques. The soft fibre's core offers gentle stretch for enhanced comfort while sinking into its cushions. The dining table's shield-shaped supports and rounded ceramic top make it a timeless centrepiece, complementing any outdoor setting.

# TRIBÙ



ARMCHAIR



LOUNGE CHAIR



DINING TABLE  
240 X 110 CM



DINING TABLE  
320 X 115 CM

## FRAME

10-LINEN

20-CLAY

89-WENGÉ

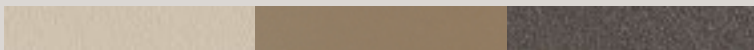

## WEAVE

10-LINEN

89-WENGÉ



## TABLE TOP

C11-SIENNA

C76-PEBBLE

C86-POMPEI

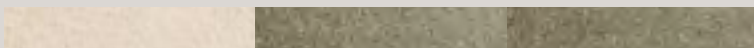

\*see pricelist for more information

TRIBÙ

# SENJA

STUDIO SEGERS



# ORGANIC CORNER MODULE

SENJA introduces an innovative extension module featuring a 135-degree angle. This addition enhances the sofa's modular versatility, allowing for the creation of organically shaped settings. Effortlessly connect it with the existing sofa, armchair, and lounge components, or position it at the end, creating a cozy enclosure. Alternatively, it can stand alone as an isle of relaxation. This uniquely angled SENJA module continues to push the boundaries of outdoor comfort and style, ensuring every corner to be inviting and chic.

# TRIBÙ



POUF MODULE



SINGLE MODULE



DOUBLE MODULE



RIGHT CORNER  
ARM HIGH



LEFT CORNER  
ARM HIGH



RIGHT CORNER  
ARM LOW



LEFT CORNER  
ARM LOW



2-SEATER  
ARM HIGH



2-SEATER  
ARM LOW

## FRAME

10-LINEN

89-WENGÉ



## LEGS

T-TEAK

10-LINEN

89-WENGÉ

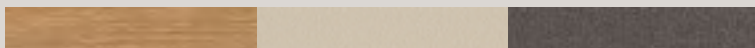

\*see pricelist for more information

TRIBÙ

# CESTA

MONICA ARMANI

# SWIVEL LOUNGE CHAIR

CESTA draws its inspiration from traditional basket weaving methods. From ancient plaiting and coiling to modern industrial weaving designed for elevated outdoor style, enjoyment, and durability, today's artisans interpret time-honoured skills using aluminium and rope. Distinguished by clean lines and minimal adornment, CESTA's woven backrest plays the starring role. The sumptuous cushioning complements the sleek frame, while the seat offers gentle movement from side to side, making it perfect for relaxed groupings and intimate conversations.



# TRIBÙ



---

LOUNGE CHAIR

## FRAME

10-LINEN



## WEAVE

10-LINEN



TRIBÙ

# MR TRICOT

ILIA ECKHARDT

# WIRED ADDITIONS

MONSIEUR TRICOT is a collection of knitted and hand crocheted lighting elements that turn outdoor spaces into a magical place. The new 2025 additions will deepen your connection to them even further. All standing models (30-40-60 cm) of Monsieur Lebonnet, Madame Latoque and Madame Cachet come in a new wired version (220V), equipped with a five-meter cable and an easy-to-use on-off switch. Crafted in high-performing materials and modern technology, they are CE certified and suitable for outdoor use.

# TRIBÙ



---

STANDING LAMPS

## KNIT

10-LINEN

30-MOSS

60-BRICK

89-WENGÉ

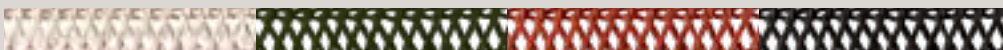

TRIBÙ

# SEREN

TRIBÙ STUDIO

## LOW TABLES

Introducing SEREN, a coffee table collection that embodies sophistication, functionality, and versatility. The essence of SEREN's design lies in its interchangeable bases and tops, crafted from premium materials including teak, aluminium, travertine, and ceramics. Combined with a variety of height options, these allow for endless design possibilities. Though inherently robust, SEREN retains a sleek and refined aesthetic. Inspired by the serenity of nature, its soft, rounded edges lend a sense of fluidity and grace, creating a balance between form and function.

# TRIBÙ



---

SIDE TABLE 58 X 58  
H 39 / 46 CM



---

COFFEE TABLE 150 X 100  
H 32

## FRAME

10-LINEN

20-CLAY

T-TEAK

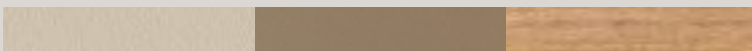

## TABLE TOP

C11-SIENNA

C60-MARRONE

C76-PEBBLE

TV-TRAVERTINE

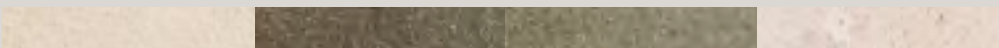



TRIBÙ

# MARE

MARC MERCKX

## SIDE TABLES

Imagine the soothing rhythm of waves on a light blue ocean. It was the inspiration behind MARE. This side table is a reinterpretation of the classic Martini table. Designed for effortless use on lazy afternoons or cozy nights, it can be easily positioned beside sofas and loungers, with the base sliding underneath. Its textured glass tabletop enhances the lightness of the design, casting gentle ripples across the floor as sunlight dances upon its surface. MARE is a must-have addition to any outdoor setting, where every moment spent feels like a holiday.

# TRIBÙ



SIDE TABLE DIA 32  
H 40/50 CM



COFFEE TABLE DIA 48  
H 40/50 CM

## FRAME

10-LINEN

20-CLAY

89-WENGÉ

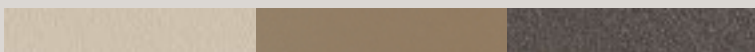

## TABLE TOP

G40-DUSK

G88-AMBER



TRIBÙ

# TRIBÙ FABRICS

Simple and sophisticated. Vibrant and soothing. Soft and strong at the same time. Like nature itself, Tribù's 2025 fabrics are a blend of the best it has to offer. They merge human craftsmanship and innovation with nature's beauty, effortlessly withstanding its elements. Reflecting tranquil earthy tones, refreshing ocean blues, and serene forest greens, all shades and textures are designed to make life's moments extraordinary. Every thread and weave is a tribute to the great outdoors, where elegance comes naturally.



TRIBÙ



ELMINA<sup>®</sup>  
*môj životný štýl*

ELMINA Bratislava | OC LIGHTPARK | Račianska 90 | Bratislava  
**[www.elmina.sk](http://www.elmina.sk)** | [elmina@elmina.sk](mailto:elmina@elmina.sk) | +421 910 919 711  
Ceny vr. DPH

## THE ART OF LEISURE

Living the good life outside with family and friends, is the very core of our family brand. We feel privileged continuing the heritage of our father Lode and grandfather Henri, who laid the foundations of a shifting lifestyle towards a luxury outdoor living experience.

And year by year, our tribe grows stronger.

Following the launch of our Los Angeles flagship store, we are opening the doors of our flagship showroom in the design capital of the world, Milan. We are thrilled to invite you to join us on our journey and experience the good life outside, worldwide. Let's celebrate innovation, craftsmanship and timeless luxury design together. Live it, love it, share it.

Have a wonderful outdoor year.

Koen & Tom De Cock







006	SURO
024	AMANU
036	UKIYO
048	NODI
058	SENJA
070	ELIO
080	VIS À VIS
088	TOSCA
100	NOMAD
106	MOOD
120	NATAL ALU
126	CTR
136	BRANCH
144	KOS
150	PURE
160	ILLUM
170	PAVILION
172	MONSIEUR TRICOT
178	ACCESSORIES
198	PROJECT REFERENCES
226	TECHNICAL SPECIFICATIONS



# SURO

CHRISTOPHE DELCOURT

The mastery of materials and curves truly characterises Christophe Delcourt's Suro collection, which embodies the symbiosis of a solid seating in wood or aluminium and its braided rope weaving.







PURE sofa in teak with cushions in taman linen, deco cushions in naram almond, canvas tuscan linen, gaelic sandstone with piping in natté ochre and linen, sujàn hemp, sujàn ochre, dalsace flax and knit colorado.  
SURO lounge chairs in teak/hemp with cushions in naram almond. ROOTS side table in teak. NATAL ALU X round side table in clay. MAI square poufs in hemp. DUNES low dining table in teak. SHINDI rug in hemp.





SURO armchairs in clay/linen with cushions in sujân hemp. NOX dining table 352cm in wengé with top in lava stone linen. SHINDI rug in linen.

Suro's sophisticated material combination creates a comfortable and inviting cocoon-like seat reminiscent of flower petals. The wood or aluminium frame adds simplicity and solidity to the seat's structure, while the weave of the round fiber backrest provides embracing comfort. Delcourt's approach resembles a sculptor's, perfectly blending form and function to create a timeless refined design.





SURO lounge chairs in clay/linen with cushions in naram almond. GOBI basket small in linen. OTTO side table in teak ø48cm h32cm with top in travertine. MAI rectangular poufs in hemp. NODI sofa in wengé with cushions in gaelic sandstone, deco cushions in naram white, sujàn hemp, canvas tuscan linen and gaelic sandstone with piping in natté ochre. DUNES side table in teak. SHINDI rug in hemp.





SURO banquette in teak/hemp with cushions in rustic weave brown, deco cushions in rustic weave brown, tagika terracotta, gaelic mushroom and knit dark copper. DUNES low dining table in teak. SURO lounge chair in teak/hemp, cushion in knit dark copper, deco cushions in gaelic mushroom and gaelic dark copper. NOMAD pouf M in knit dark copper. SHINDI rug in hemp.





SURO lounge chairs in teak/hemp, cushions in knit dark copper. NODI sofa in wengé with cushions in taman linen, deco cushions in tagika terracotta with piping in linen, gaelic mushroom, gaelic sandstone, rustic weave brown and gaelic dark copper. OTTO side table in teak ø48cm h32cm with top in travertine. VIS A VIS low tables in teak. ROOTS side tables in teak. LUNA lamp in wengé. SHINDI rug in linen.





OTTO dining table rectangular in teak with top in travertine. SURO armchairs in teak/hemp with cushions in gaelic dark copper. SHINDI rug in hemp.





SURO dining table in teak, 2x 280cm combined. SURO armchairs in teak/hemp with cushions in gaelic dark copper. VIS A VIS bench in teak. SHINDI rug in hemp.





SURO dining table in teak, 2x 280cm combined. SURO armchairs in teak/hemp with cushions in gaelic dark copper. VIS A VIS bench in teak. SHINDI rug in hemp.



# AMANU

YABU PUSHELBERG

The refined Amanu collection brings interior quality outside,  
combining comfort and sustainability in a design that  
exudes purity.







AMANU armchairs and dining table 350cm in teak with top in ceramic sabbia, cushions in taman linen. LANTERNS high and low in teak. SHINDI rug in linen.

The chairs feature woven, hemp-based Canax® sling seats that seem to float from a slimline-teak frame whose slightly tapered legs provide elegance and grace. The broad, ceramic tabletop tiles are supported by a discreet, yet sturdy teak frame, creating a remarkable lightness. The rounded edges of both the teak profiles and the outer ceramic tiles, convey a soft and harmonious look.





NODI sofa in wengé with cushions in taman white, deco cushions in natural sandy dunes with piping in canvas lace, natural cloudy sky, natté stardust and natural dark brown. AMANU lounge chairs in teak, cushions in natural dark brown. VIS À VIS coffee tables 99x99cm in teak. TAIRU side table in teak with top in lava stone linen. SHINDI rug in linen.





NODI sofa in wengé with cushions in taman white, deco cushions in natural dark brown, natural aged ivory with piping in natté ochre, natural cloudy sky, natté ochre with piping in linen and natural dark brown with piping in canvas lace. AMANU lounge chairs in teak. ROOTS side table in teak. TAIRU side table in teak with top in lava stone wengé. NATAL ALU X side tables 60x60cm in wengé. DUNES side table in teak. LANTERNS high and low in teak. SHINDI rug in hemp.





AMANU lounge chair in teak. VIS À VIS sofa with cushions in rustic weave cord, deco cushions in natté ochre with piping in canvas lace, natural dark brown with piping in canvas lace, natural sandy dunes with piping in natté ochre and sujân ochre. TAO coffee table in concrete linen. NATAL ALU X table ø35cm h45cm in wengé. SHINDI rug in hemp.





AMANU armchairs and dining table 350cm in teak with top in ceramic sabbia. NODI sofa in wengé with cushions in taman white, deco cushions in natural sandy dunes with piping in canvas lace, natural cloudy sky, natté stardust and natural dark brown. AMANU lounge chairs in teak. VIS À VIS coffee tables 99x99cm in teak. TAIRU side table in teak with top in lava stone linen. SHINDI rug in linen.



# UKIYO

MONICA ARMANI

Inspired by Japanese handwriting, the Ukiyo collection balances out curved and taut lines resulting in intriguing designs that are as comfortable as they are elegant.







UKIYO dining table in teak with top in ceramic linen, chairs in teak with cushions in naram almond. SHINDI rug in hemp.

After visiting Japan, designer Monica Armani was inspired by its culture and writing system. Delicate yet uniquely shaped brushstrokes shape a world of stories and tales, as does the Ukiyo collection, effortlessly balancing elegance, design and comfort. Each collection piece perfectly blends in with nature while remaining etched into the view and your memory, its meticulous design telling a story of outdoor pleasure.





UKIYO lounge chairs in teak with cushions in knit rosemary, coffee tables in teak with top in ceramic sabbia. VIS À VIS sofa in teak with cushions in chalk, deco cushions in naram almond, knit rosemary, chalk with piping in natté ochre, taman linen and canvas tuscan linen. OTTO side table in teak ø60cm h32cm with top in travertine. DUNES side table in teak. SHINDI rug in linen.





UKIYO coffee table in teak with top in ceramic sabbia. NODI sofa in wengé with cushions in naram warm cotton, deco cushions in naram almond, knit rosemary, sujàn hemp, gaelic dark copper, taman linen and gaelic mushroom. OTTO side table in teak ø60cm h32cm with top in travertine. LUNA lamp in wengé. DUNES side table in teak. NATAL ALU X side table ø35cm in wengé. NOMAD pouf S in sujàn hemp. SHINDI rug in hemp.





UKIYO loungers in teak with cushions in naram almond. OTTO side tables in teak ø60cm h30cm with top in travertine and ø48cm h20cm with top in ceramic sabbia. GOBI baskets small and large in linen.





UKIYO lounge chairs in teak with cushions in sujàn hemp. T-TABLE ELIPSE low dining in linen with top in ceramic sabbia. VIS À VIS sofa in teak with coffee table 99x99cm in teak, cushions in chalk, deco cushions in chalk, naram almond, taman linen, canvas tuscan linen and sujàn hemp. LUNA lamps in wengé. OTTO side tables in teak ø60cm h32cm with top in travertine. DUNES coffee table in teak. NATAL ALU X side table ø35cm h45cm in wengé. SHINDI rug in linen.



# NODI

YABU PUSHELBERG

With its openness and supreme comfort, Nodi exhibits refined elegance and ingenious design that blends in easily in any outdoor setting.







NODI sofa in white, cushions in tagika nature grey, deco cushions in sujàn ochre, taman linen, natté basalt with piping in canvas lace and natté ochre with piping in canvas tweed brown.  
 NODI lounge chairs in white. DUNES side table in teak. ROOTS side table in teak. T-TABLE low dining table ø90cm in linen with top in ceramic sabbia. NODI loungers in white. SHINDI rug in linen.

Light and airy, Nodi's form and silhouette are characterised by twisted, interlaced rope in weather-resistant Canax®, stretched across a precise geometric wireframe. Refined proportions and a minimalist approach to materiality lend a casual lightness to the collection. The slim profile of the chair's arm is angled slightly inward in a welcoming gesture while the feather-soft cushions of the modular Nodi sofa are simply made for laid-back lounging.





NODI chairs in wengé. T-TABLE dining table 298cm in wengé with top in ceramic scisto. SHINDI rug in wengé.





NODI sofa in wengé, cushions in taman white sand, deco cushions in sujàn ochre, natté ochre, tagika mist, natural aged ivory, natté basalt with piping in canvas tuscan linen and natté basalt with piping in linen.  
NOMAD lounge chair, cushion in taman linen, deco cushion in sujàn ochre. T-TABLE coffee table ø90cm in wengé with top in ceramic sabbia. VIS À VIS coffee table 99x99cm in teak. DUNES side table in teak.  
SHINDI rug in hemp.





NODI lounger in wengé, cushion in chalk. DROPS side table ø40cm in wengé.



# SENJA

STUDIO SEGERS

The elegant lines of Senja create a sense of calm with an uncompromised design aesthetic. Senja collection is in utter harmony with nature and offers indulgent comfort.







SENJA armchairs with linen weave, wengé seat and legs, cushions in taman linen. NOX dining table 352cm in wengé and top in ceramic scisto. SHINDI rug in hemp.

The light design of the Senja chairs, combined with the rhythm of the tightly stretched weave in hemp-based Canax® creates a perfect symbiosis between aesthetics and functionality. Senja is a full collection consisting of countless seating options with a modular sofa, meridienne, lounge, arm- and lounge chairs and a complimenting coffee table.





SENJA sofa with linen frame and legs, cushions in natural seashell, deco cushions in tagika eucalyptus with piping in linen, natural seashell with piping in canvas lace, natural dark brown with piping in canvas lace, natural sage green and natural dark brown with piping in canvas lace. SENJA lounge chair with linen seat and teak legs, cushions in canvas seasalt. T-TABLE low ding table ø125 in linen with top in ceramic linen. DUNES side table in teak. NOMAD pouf small in natural dark brown. SHINDI rug in linen.





SENJA lounge in linen with optional side table in teak, cushion in tagika eucalyptus. DUNES side table in teak.





SENJA sofa with linen frame and legs, side table in teak, cushions in natural seashell, deco cushions in tagika fresco, rustic weave fresco, canvas tweed brown with piping in blush and canvas seasalt.  
SENJA lounge chair with linen seat and teak legs, cushions in rustic weave fresco. DUNES coffee table in teak. BRANCH coffee tables ø85, 60, 50cm h27cm in linen with top in concrete. TAIRU side table in teak with top in lava stone linen. MADAME LATOQUE standing lamp ø40cm in linen. SHINDI rug in linen.





SENJA lounge chairs with linen seat and teak legs, cushions in natural dark brown, deco cushions in tagika fresco and rustic weave brown with piping in canvas lace. DUNES coffee table in teak.



# ELIO

YABU PUSHELBERG

The Elio collection captures the duality of heritage textile techniques and contemporary solution dyeing, making each piece of furniture one-of-a-kind.







ELIO lounge chairs in linen with cushion in linen, deco cushion in tagika moss. MOOD 2-seat sofa with cushions in taman linen, deco cushions in tagika moss and canvas cotton white. TAIRU side table in teak with top in lava stone moss. DUNES side table in teak.

Elio, referring to the Greek sun god Helios, is inspired by the motion of light, reflecting on landscapes and objects throughout the day. The rich gradient effect in the seat and backrest, achieved by weaving multiple colours of yarn into one strand, mimics the gentle touch of light. Elio is characterised by a softly rounded silhouette that draws inwards to create a warm, intimate shelter.





ELIO lounge chair in wengé, cushion in natté ochre. BRANCH side table ø50cm h35cm in wengé with teak top.





ELIO chairs in linen, cushion in taman linen. OTTO dining table round ø148cm with top in ceramic sabbia. SHINDI rug in linen.





ELIO chairs in linen, cushion in naram almond. ILLUM table 267x100cm in teak with top in teak.



# VIS À VIS

PIERGIORGIO CAZZANIGA

The Vis à Vis collection gives wooden outdoor furniture a new dimension by combining modular comfort with a natural look.







VIS À VIS dining table 300cm and chairs in teak, cushions in taman linen.

Slender teak platforms in the modular Vis à Vis sofa support comfortable all-weather cushions without any visible back or arm structure. The collection contains a lounge with an integrated side table that can connect to a parallel lounge. The dining table - available in different lengths - can be extended without any limit. The outdoor, lounge and rocking chair are upholstered with an airy weave in Canax®, composed of PVC and natural hemp.





VIS À VIS sofa in teak with cushions in chalk, deco cushions in naram almond, sujàn hemp, chalk, taman linen and canvas tuscan linen with piping in natté ochre and canvas tweed brown. VIS A VIS coffee table 99x99cm in teak. UKIYO lounge chair in teak, cushion in knit morning dew. GOBI basket small in linen. DUNES side and coffee table in teak. OTTO side table in teak ø48cm h32cm with top in travertine. SHINDI rug in hemp.





VIS À VIS lounge in teak, cushion in linen scisto. LANTERNS high and low in teak. SHINDI rug in hemp.



# TOSCA

MONICA ARMANI

Tosca is simultaneously warm and inviting, stylish and intriguing.

Rounded forms, tapered legs and an elegant seating shell, upholstered with extra wide braiding, characterise its design.

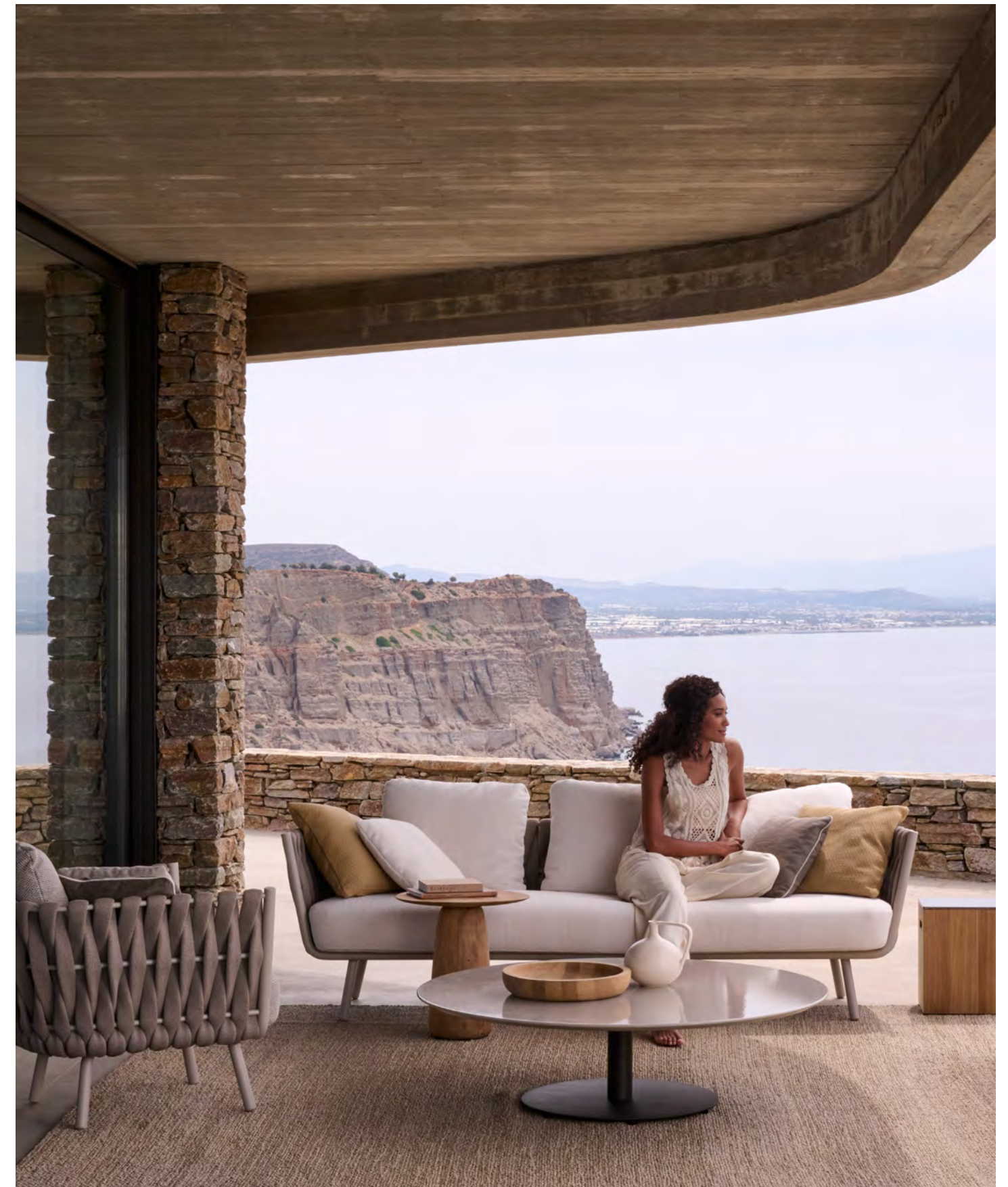





TOSCA lounge chair in linen with cushions in sujàn, hemp, deco cushions in natté ochre and gaelic pearl, sofa 3-seater in linen with cushions in naram warm cotton, deco cushions in sujàn ochre and leaf.  
 NOMAD lounge chairs in teak, cushions in chalk, deco in knit rosemary. T-TABLE coffee table wengé ø125cm with top in lava stone linen. TAIRU side table in teak with top in lava stone wengé. DUNES coffee table in teak.  
 GOBI basket small and large in linen. POUFS in naram warm cotton. NOMAD poufs S in naram warm cotton, deco cushions in knit rosemary. SHINDI rug in hemp.

Tosca is the perfect mix of innovation and beauty, a collection as inviting to curl up in as it is intriguing to look at. The giant weave in hi-tech 'knitting', soft to the touch and completely weather-resistant, is complemented by slim legs in powder-coated stainless steel. The soft, tonal contrasts between the weave and frame add to the discreet luxury





TOSCA sofa 3-seater in linen with cushions in naram warm cotton, deco cushions in natural dark brown with piping in linen, taman white and sujän ochre. TOSCA low dining table 298cm in linen with top in ceramic linen, low dining chairs in linen, cushions in naram warm cotton, deco cushions in sujän ochre. TOSCA lounge in linen, cushion in taman linen. GOBI basket small and large in linen. TAIRU sidetable in teak with top in lava stone linen. DUNES coffee table in teak. SHINDI rug in hemp.





TOSCA chairs in linen, cushions in taman linen and naram pearl. TAO table ø160cm in linen. SHINDI rug in linen.





TOSCA daybed in linen, cushions in natural sage green and naram warm cotton, deco cushions in natural sage green and canvas seagrass with piping in canvas lace. DUNES side table in teak. GOBI basket small and large in linen.





TOSCA chairs in wengé, cushions in taman linen and naram pearl. NOX dining table 352cm in wengé with top in ceramic scisto. SHINDI rug in wengé.



# NOMAD

MONICA ARMANI

Sculpted from warm teak wood Nomad enhances every space due to its soft shapes and subtle lines.







NOMAD lounge chairs in teak, cushions in tagika moss. DUNES side table in teak.

Nomad represents 'noble teak wood' for its warmth, smoothness and strength. Slender legs and contoured armrests give its profile a certain elegance. Tailored cushions add luxury and comfort to its uniquely curved silhouette. Nomad, like its name, works well wherever it is placed.





NODI sofa in wengé, cushions in taman white sand, deco cushions in tagika moss, sujàn moss, rustic weave moss, natté stardust, taman linen, tagika moss with piping in canvas lace, taman linen with piping in linen and canvas seagrass with piping in canvas lace. NOMAD lounge chairs in teak, cushions in taman linen. T-TABLE coffee table 298cm in wengé with top in ceramic scisto. DUNES side table in teak. NOMAD pouf S in tagika moss, pouf M in rustic weave cord. SHINDI rug in linen.



# MOOD

STUDIO SEGERS

Two simple materials – teak and woven cord – have been elevated to create a warm outdoor collection that carries a timeless quality.







MOOD lounge bed in linen with cushions in taman linen, deco cushions in natural dark brown with piping in linen, natté basalt with piping in canvas lace, gaelic mushroom, gaelic sandstone, naram almond with piping in canvas tweed brown and sujān hemp. DUNES side table in terrazzo by Tribù. MOOD chair in linen with cushion in taman linen and casual back cushion in gaelic sandstone. T-TABLE dining table ø90cm in linen with top in lava stone wengé.

Mood greets you with its warm presence, comfortable seating and utter craft with a handwoven back. Combining the natural beauty of high-quality plantation teak with a weave in refined, soft Tricord®, Mood collection features casual comfort and elegance.





MOOD daybed in earthbrown with cushions in naram pearl and sujân hemp, deco cushions in knit rosemary, taman poivre with piping in leaf and naram pearl. DUNES coffee table in teak. GOBI basket large in linen. LUNA lamp in wengé.





MOOD chair in linen, cushions in taman linen and casual back cushion in sujän ochre. TAO oval dining table in wengé. MONSIEUR ELLISPE hanging lamp in linen.





MOOD 2-seat sofa in linen with cushions in sujån ochre, deco cushions in naram pearl with piping in natté ochre, knit colorado, gaelic ochre and dalsace flax. PURE sofa in teak with cushions in taman linen, deco cushions in sujån hemp with piping in canvas lace, knit colorado, dalsace flax, natté ochre, sujån ochre, naram pearl with piping in natté ochre and natural off-white. MOOD lounge chair in linen with cushion in sujån ochre and naram pearl. LUNA lamp in wengé. OTTO side table in teak ø48cm h45cm with top in travertine. DUNES side table in teak. T-TABLE coffee table ellipse in linen with top in lava stone linen. TAIRU side table in teak with top in lava stone linen. SHINDI rug in linen.





MOOD lounge chairs in earth brown with cushions in knit dark copper. OTTO side table in teak ø48cm h32cm with top in travertine.





MOOD 2-seat sofa in earth brown with cushions in knit rosemary, deco cushions in gaelic mushroom, sujàn hemp, natural dark brown with piping in linen and knit in morning dew. ELIO lounge chair in linen with cushion in taman linen and deco cushion in knit rosemary. MAI rectangular pouf in hemp. OTTO side table in teak ø48cm h32cm with top in travertine. DUNES coffee table in teak.



# NATAL ALU

STUDIO SEGERS

The Natal Alu collection combines functionality with aesthetics in a contemporary but timeless design.







NATAL ALU meridienne in wengé with cushions in natural off-white, deco cushions in taman linen, natural dark brown with piping in canvas lace and natural cloudy sky. AMANU lounge chair with cushion in natural dark brown. ROOTS side table in teak. DUNES side table in teak. NOMAD pouf M in rustic weave cord. SHINDI rug in wengé.

The Natal Alu sofa displays Tribù's design and technical skills with a slender, minimal frame and generous, water-repellent cushions. Twenty different modules with two different seat depths can be adapted to fit any space with refined elegance. The wide range of fabrics adds to the flexibility of this timeless sofa.





NATAL ALU sofa in linen with cushions in natural dark brown, deco cushions in natural dark brown with piping in linen and natural off-white. ROOTS side table in teak. NATAL ALU X round table in linen. T-TABLE coffee table ø80cm in linen with top in lava stone linen. TAIRU side table in teak with top in lava stone wengé. AMANU lounge chair in teak with cushion in natural dark brown with deco cushion in natural off-white. SHINDI rug in wengé.



# CTR

PIERGIORGIO CAZZANIGA

CTR looks effortless in all its ingenuity. With a lightness of touch,  
the open weave adds subtle elegance to any outdoor scene.







CTR meridiennes in white/linen, cushions in chalk, deco cushions in natté ochre with piping in canvas lace and canvas lace with piping in canvas tweed brown. DUNES side table in teak. NOMAD pouf L in natural sandy dunes, S in sujän ochre. SHINDI rug in hemp.

The CTR collection catches your eye with a tube in powder-coated stainless steel that follows its outline in one continuous line. The open weave of the backrest appears to float unsuspected around the upholstered seat. The CTR collection is a complex design created with effortlessness and innovation.





CTR lounge chair in wengé/wengé, cushion in tagika moss with deco cushion in leaf with piping in canvas lace. DUNES side table in teak. VIS à VIS sofa in teaj with cushions in natural off-white, deco cushions in natural off-white. VIS À VIS coffee table 99x99cm in teak. MADAME LATOQUE standing lamp ø30cm in moss. SHINDI rug in hemp.





CTR lounge chair in wengé/linen, with cushions in natural dark brown and taman linen. T-TABLE low dining ø125cm in wengé with top in lava stone wengé. MONSIEUR LEBONNET standing lamp 60cm in linen. MADAME LATOQUE standing lamp 30cm in linen.





CTR chairs in linen/linen, cushions in knit rosemary. NOX table 352cm in linen with top in lava stone moss. SHINDI rug in hemp.



# BRANCH

LIEVORE ALTHERR MOLINA

Inspired by tree branches, the Branch collection has a sleek, organic look that relies on a sophisticated design and well-thought-out materials.







BRANCH side chairs and dining table ø125cm in linen, seat cushions in natural sandy dunes. MONSIEUR LEBONNET standing lamp ø60 and ø40cm in linen. MADAME LATOQUE standing lamp ø40cm in linen.





BRANCH dining table 300x110cm in wengé with teak top, arm and side chairs in wengé, seat cushions in canvas seasalt.

Just as sunlight filters through the branches of a tree, so it illuminates the Branch collection. Slender legs and lattice seats give Branch a delicate lightness, while the clever design and hi-tech materials make the collection highly comfortable and durable. "Branch strengthens the emotional connection with nature. It creates a feeling of respect and fascination with the natural environment", says designer Manel Molina.





BRANCH loungers in wengé, cushions in natural sandy dunes. DUNES side table in teak. LANTERNS high and low in teak.



# KOS

STUDIO SEGERS

The Kos collection enhances the robust character of teak with a purified yet powerful twist.







PURE sofa in teak with cushions in naram pearl, deco cushions in taman poivre, gealic mushroom and natural dark brown with piping in canvas lace. KOS lounge chairs in teak with cushion in taman linen. T-TABLE low dining table ø90cm in linen with top in lava stone wengé. DUNES side table in terrazzo by Tribù. SHINDI rug in linen.

Kos is beautiful on its own, yet combined with other collections its robustness and graceful design add excitement to any outdoor setting. Kos is the perfect companion to create the essence of outdoor living, any time of the year.





KOS lounge in teak with cushion in knit rosemary.



# PURE

ANDREI MUNTEANU

True simplicity offers infinite versatility. The sculptural Pure family captures that in the most sophisticated, ingenious way, adding luxurious elements to its never outdated heritage.







PURE sofa in teak with cushions in natural aged ivory, deco cushions in natté basalt, rustic weave cord, taman linen, natural aged ivory with piping in canvas tweed brown and natté wengé with piping in linen.  
VIS-À-VIS coffee table 99x99cm. in teak. LANTERN high and low. SHINDI rug in wengé.





PURE sofa in teak with cushions in naram pearl, deco cushion in taman linen, gaelic mushroom, natural dark brown with piping in linen, sujàn hemp, dalsace flax and gaelic sandstone. ELIO lounge chairs with cushions in taman linen, deco cushion in gaelic mushroom. DUNES coffee and side table in teak. MAI square pouf in hemp. NATAL ALU X round table in clay. SHINDI rug in linen. MONSIEUR LEBONNET standing lamp ø40cm in linen. MADAME LATOQUE standing lamp ø30cm in linen.

The Pure collection truly changed the way we think about outdoor furniture. And even after decades, its bestseller story continues. New contemporary elements like a two seat extension, a luxurious lounge and cabana are taking Pure's modularity to yet another level. Together with the five existing modular elements, comfortably accessorized with deep stylish cushions, Pure creates timeless and harmonious outdoor rooms, effortlessly adapting to every possible atmosphere.





PURE lounge in teak with cushion in naram pearl.





PURE loungers in teak with cushions in naram pearl. GOBI basket large in linen.



# ILLUM

MERCKX & MAES

The Illum collection is an ode to form and function. Durable materials are used throughout the collection, with smooth transitions from crisp to soft lines.

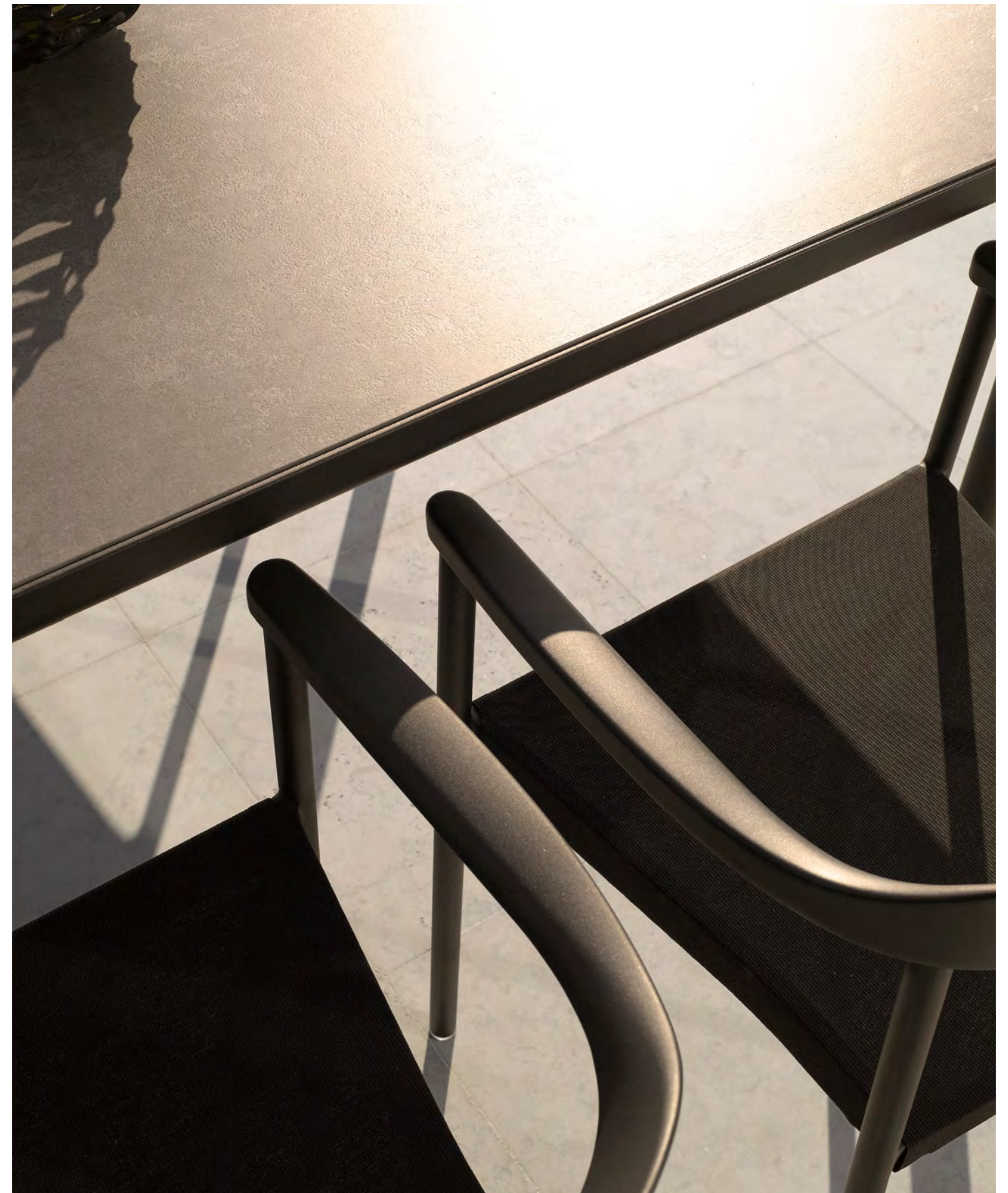





ILLUM lounge and armchairs in wengé, bench and dining table 267x100cm in wengé with teak top.





ILLUM lounge in wengé.

The Illum collection refers to the classical Scandinavian furniture archetypes, translated with updated materials for outdoors. Aluminium is used like sculpted wood and Batyline® for the seating, serving both looks and durability. Batyline® has a lasting high tension and is known to be UV resistant, quick dry and dirt repellent. The soft-curving back of the chair provides an inviting view and seating comfort. Functionality is paramount for Illum, without compromising on comfort and class.





ILLUM armchairs in white and dining table 267x71cm in white with top in ceramic piombo.





TAO oval dining table in wengé. ILLUM armchairs in clay with cushion in naram almond.  
SHINDI rug in linen.

When it comes to comfort and luxury, Pavilion undoubtedly triumphs. The classic canopied bed was given a modern yet timeless look with customization options according to your preference. This well-designed daybed is your perfect companion for outdoor relaxing in style



# PAVILION

MONICA ARMANI

Pavilion introduces contemporary design and  
luxurious elegance at its best.

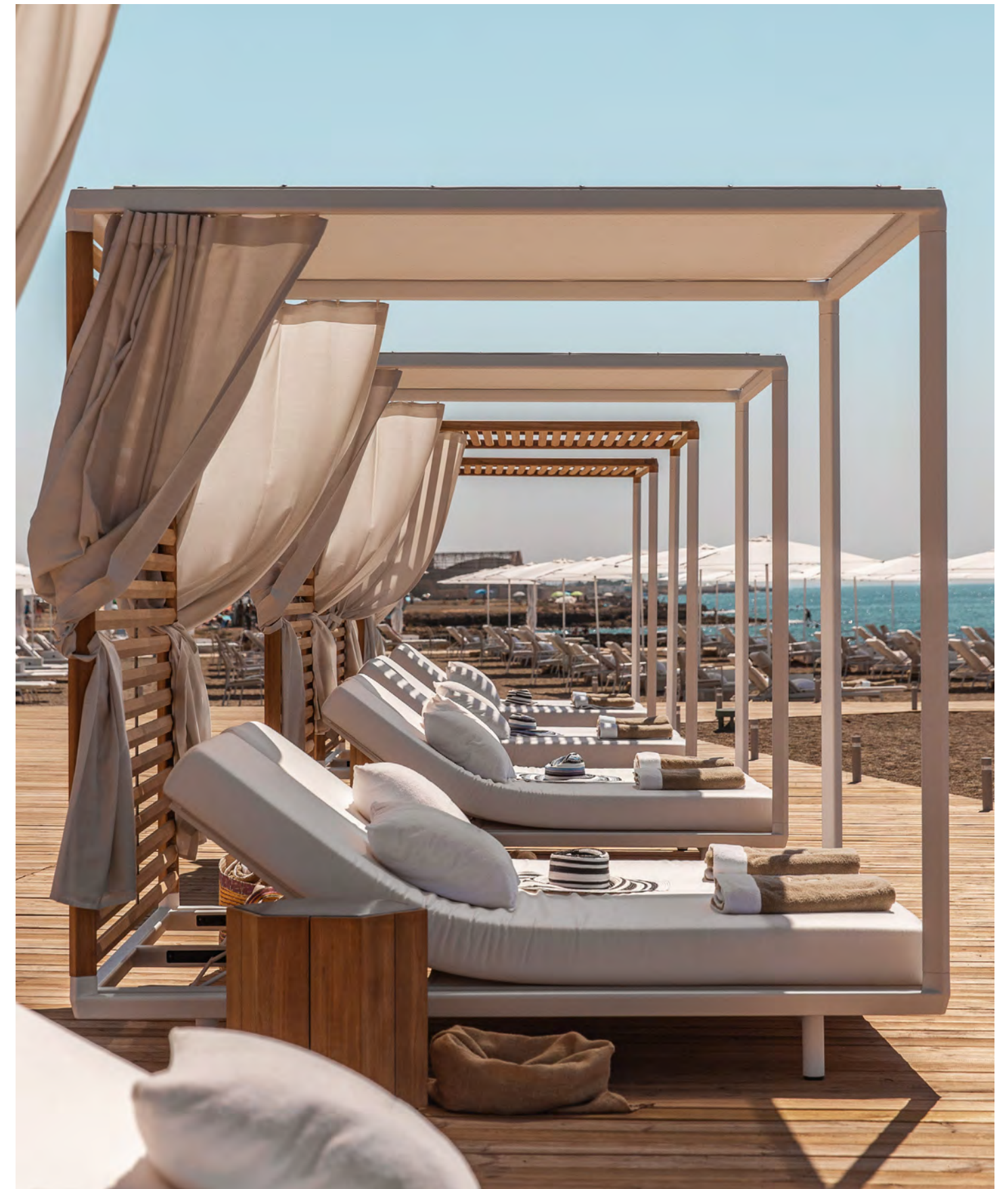



# MONSIEUR TRICOT

ILIA ECKARDT

Monsieur Tricot is a distinctive collection of knitted and hand crocheted outdoor lighting that give a warm glow and cast beautiful shadows.







MONSIEUR LEBONNET standing lamps ø30cm, ø40cm and ø60cm in linen. MADAME CACHET standing lamps ø50cm in linen. MADAME LATOQUE standing lamp ø30cm in linen. CTR lounge chairs in wengé/linen, cushions in natural dark brown and taman linen. T-TABLE low dining table ø125cm in wengé with top in lava stone wengé.





MADAME LATOQUE hanging lamp ø30cm and ø40cm in wengé. MADAME CACHET hanging lamp ø40cm in wengé.

Monsieur Tricot is a collection of distinctive knitted and hand crocheted outdoor lighting. The hanging and standing lamps, designed by Belgian designer Ilia Eckardt, merge traditional techniques with high-performance materials and modern technology. Ilia grew up immersed in the Belgian fashion scene, his mother working for Belgian fashion designers like Raf Simons and Dries Van Noten. Fascinated by their world, he designed his own outdoor lighting collection which he composed as a family. Meet the handsome Monsieur Lebonnet, the graceful Madame Latoque, the chic Madame Cachet and their nephew Monsieur Ellipse. The lights give a warm glow and cast beautiful shadows for long summer nights.



# ACCESSORIES







GOBI basket small and large in linen.



ACCESSORIES



LUNA lamps in wengé. VIS A VIS low tables.



MAI rectangular and square poufs in hemp. DUNES side table in teak. MONSIEUR LEBONNET standing lamp ø40cm in linen. MADAME LATOQUE standing lamp ø40cm in linen.





LUNA lamps in wengé. MAI poufs rectangular in hemp. TAIRU side table in teak with top in lava stone wengé. OTTO side tables in teak ø48cm h32cm and h. 45cm with top in teak.

ACCESSORIES



NOMAD pouf S in sujàn hemp, knit dark copper and naram almond, pouf in M in sujàn hemp. DUNES side table in teak. MONSIEUR LEBONNET standing lamp ø30cm in linen. MADAME LATOQUE standing lamp ø40cm in linen.





LUNA lamps in wengé. OTTO side tables in teak ø60cm h32cm with top in travertine. DUNES coffee table in teak.





MADAME LATOQUE standing lamp ø30cm in linen. ROOTS side tables in teak.





DUNES coffee and side table in teak.





LANTERNS large and small in teak.

ACCESSORIES

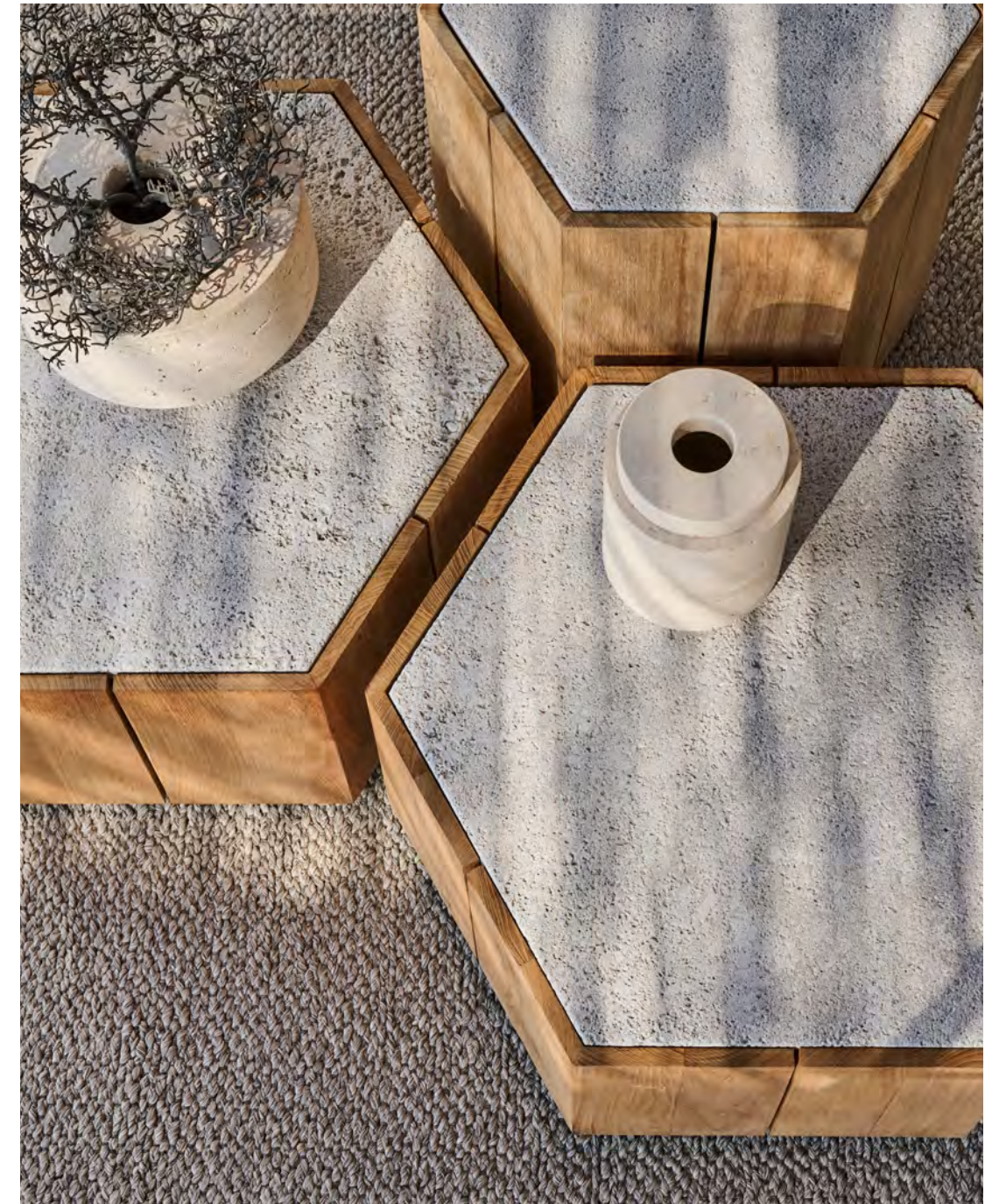

HEXAGON coffee and side table with top in muschelkalk (on request).





LUNA lamps in wengé. OTTO side table in teak ø48cm h32cm with top in ceramic sabbia.





ECLIPSE umbrellas round 350cm in wood.



# PROJECT REFERENCES



© MR. TRIPPER





SOUKI LODGES & SPA  
OCCITANIA, FRANCE

© MR. TRIPPER

The two eco-luxury cabins at Souki Lodges & Spa in the spectacular Hérault region of southern France offer a complete escape into unspoiled nature. These seductive retreats are open to the views and scents of the wooded hills and aromatic garrigue that surround them, blending restful, contemporary interiors with a terrace furnished with our Mood, Senja and Branch collections.





MIX BY ALAIN DUCASSE

EMERALD PALACE KEMPINSKI, DUBAI

©PMONETTA





FOUR SEASONS HOTEL THE SURF CLUB  
MIAMI BEACH, FLORIDA





CAP VERMELL GRAND HOTEL  
MALLORCA, SPAIN





**FOUR SEASONS RITZ**  
LISBON, PORTUGAL

Architect: Openbook

The historic Four Seasons Ritz, located in the heart of Lisbon, truly embodies the cultural soul of Portugal. Outside, you can see the city's rolling hills and brightly tiled facades surrounding the pool area. The perfect place to relax after a day of sightseeing through the city or to unwind in the sun on a comfortable Senja lounge, Pavilion or Mood daybed.





In this exclusive oasis in the middle of the city, you can worship their unique sense of style of art-deco merged with an updated Louis XVI aesthetic, along with many important contemporary local artworks filling their halls. After a day of exploring the city's sights, CURA restaurant offers a seasonally inspired, Michelin-starred gastronomic experience.

Tribù was asked to create luxury outdoor furniture for the entire pool area varying from Pavilion and Mood daybeds and bar chairs, to Natal alu sofas, Senja loungers and Drops side tables. All these Tribù collections are well-depicted at the Four Seasons Ritz's outdoor space, exuding discrete luxury in the warmest colours. Perfectly fitting for the vibrant and colourful city of Lisbon.





FOUR SEASONS  
BURJ ALSHAYA, KUWAIT

©AYNUR MAMEDOVA





FOUR SEASONS MEGÈVE  
MEGÈVE, FRANCE

Bring together the Rothschild family heritage, a luxury hotelier and Tribù's classic Mood Club Chairs and what do you have? The Four Seasons Hotel Megève, destination of choice for the chic ski set since it opened in 2017.

A natural palette of stone, wood, lambswool and sheepskin unites the four interconnecting hotel chalets, the two-Michelin-starred restaurant and spa. Celebrated interior designer Pierre-Yves Rochon, known as 'the master of grande luxe', has made comfort the key to his gorgeously indulgent bedrooms, suites and public spaces.

Tribù's Mood Club Chairs are the perfect addition to the guest balconies, deep, cocooning seats from which to take in the spectacular snow-capped views of Mont d'Arbois. Their earth-brown woven seat backs in Tribù's exclusive Tricord material and warm teak frames are both weather resistant and highly durable. The Studio Segers design celebrates the appeal of natural textures and Tribù's technically advanced, soft-touch materials.





ST. REGIS MALDIVES VOMMULI RESORT  
MALDIVES

Guests arriving at The St. Regis Maldives Vommuli Resort by private sea plane might be struck first by the lush green of the tropical island, then by what could be the silhouette of a giant lobster and a whale shark.





Singapore-based architects WOW | Warner Wong Design have blended natural forms and traditional materials in their striking design for this five star resort. WOW is known for its culturally sensitive designs based on in-depth research into local building materials, designs and customs.

The terraces of the Villas on land and overwater are immaculately furnished with a plush Mood Daybed and Armchairs in teak and warm brown are accented by a Branch Bistro Table in wengé colour.





PETTOLECCHIA IL LIDO  
FASANO - PUGLIA, ITALY





#### M/Y DRAGON, COLUMBUS CLASSI 80MT

M/Y Dragon is an exceptional new yacht from Italian firm Columbus Yachts, a Palumbo Superyachts brand.

The exterior areas, which are all different in character, were furnished using only Tribù collections for the freestanding furniture, specified by the project's interior designer Francesco Guida. "The handwoven tricord of the back of the Mood armchairs, daybeds and club chairs is in perfect harmony with the natural atmosphere I had in mind. Ultimately the classic modernity of the interiors find the perfect continuity in the exterior areas creating the "timeless relaxing atmosphere" the owner requested." – Francesco Guida.





When Dragon is anchored, additional sun-trap decks open out at the bow, furnished with Mood daybeds, Vis à Vis loungers, poufs and Ile side tables.

Across the width of the teak bridge is the 200-metre-square 'beach club'. Here, Mood bar chairs are paired with Pure sofas, Mood low tables and poufs to create a flexible, relaxed club atmosphere.



# TECHNICAL SPECIFICATIONS

228	SOFAS
240	LOUNGE CHAIRS
246	CHAIRS
254	TABLES
266	LOW TABLES
272	SUNBEDS
282	ACCESSORIES



# SOFAS

## SOFAS

### TOSCA

MONICA ARMANI

P. 89, 90-91, 92





The Tosca outdoor sofa is simultaneously warm and inviting, stylish and intriguing. It was the first time TRIBU called upon a female designer to draw an outdoor furniture piece and that is evident in the design. Rounded forms, tapered legs and an elegant seating shell in powder-coated stainless steel, upholstered with extra-wide braiding. The material for the braiding is genuinely innovative: foam mousse is encased in a seamless sheath of knitted textile and polyolefine which makes the material weather-resistant, but also surprisingly soft to the touch. The seating comfort is especially pleasant, thanks to the comfortable outdoor cushions.

Code 05308

W64.25" D27.25" H27.25" SH15.75"  
W163cm D74cm H69cm SH40cm

Code 05309

W91.75" D29.25" H27.25" SH15.75"  
W233cm D74cm H69cm SH40cm

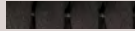
	10 - LINEN	89 - WENGÉ
<b>FRAME</b>		
	10 - LINEN	89 - WENGÉ
<b>WEAVE</b>		

### CTR





PIERGIORGIO CAZZANIGA



Italian designer Piergiorgio Cazzaniga does with the CTR collection what he is good at: making complex designs appear effortless. The frame of the sofa is made of profiles in powder-coated stainless steel that are bent in one continuous line. The corners are straight, yet the tubes keep a round form, which requires great mastery. The backrest is attached to the frame at only 2 points and appears to float unsuspected above the seat. The open weave refers to the ancient tradition of weaving and gives flexible support to the back. The seat is upholstered with a water-repellent cushion which can be easily removed.

Code 01108

W61.5" D30.25" H30" SH17.7"  
W156cm D77cm H76cm SH45cm

	00 - WHITE	10 - LINEN	89 - WENGÉ
<b>FRAME</b>			
	10 - LINEN	89 - WENGÉ	
<b>WEAVE</b>			



**SOFAS**

**MOOD**

STUDIO SEGERS

P. 114, 118

The airy design of the Mood collection and its warm combination of teak and handwoven backs will immediately create an intimate atmosphere on your patio. The rounded design of the durable teak gives the sofa a warm and friendly tone. The weave in Tricord has a very soft touch, but can nevertheless defy all weather conditions. Tribù has developed a range of natural colours that fit in with any type of outdoor environment. The comfortable outdoor cushions can be left out in the rain, thanks to the ventilating, water-repellent filling. The back cushions are available in various styles to match every taste.



Code 06208

W62.5" D35.75" H27.25" SH17"  
W159cm D81cm H69cm SH43cm

Code 06209

W91.75" D35.75" H27.25" SH17"  
W233cm D91cm H69cm SH43cm

TEAK

**FRAME**



10 - LINEN

85 - EARTHBROWN

89 - WENGÉ

**WEAVE**

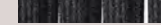

**ELIO**

YABU PUSHELBERG

Elio, referring to the Greek sun god Helios and designed by Canadian design firm Yabu Pushelberg, is inspired by the motion of light as it reflects and refracts on landscapes and objects. Multiple soft shades of yarn are woven into one strand, which mimics the hues of natural light and makes each chair unique. The handwoven seat in weather-resistant Tricord rope, draws inward to create a warm, intimate cocoon effect. The 2-seat sofa is framed by natural teak, which supports the seating shell primarily through the back legs that cross the shell.



Code 02508

W60.75" D35" H32.75" SH13.75"  
W154cm D89cm H83cm SH35cm

TEAK

**FRAME**



10 - LINEN

89 - WENGÉ

**WEAVE**



**SOFAS**

**PURE**

ANDREI MUNTEANU

P. 8-9, 114-115, 146-147, 152-153, 154-155, 173, 179, 184

Pure delicately channels design to its very essence: pure simplicity and elegance. Like a chameleon, the modular outdoor sofa adapts effortlessly to every setting and configuration. From now on the basic five elements can be seamlessly combined with the latest addition joining the Pure collection: the two seater module, generating generous extension options. Its stylish cushions provide the Pure outdoor set with a contemporary look.



TEAK

**FRAME**

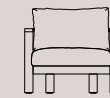

Armchair 01202s

W38.5" D38.5" H24.75" SH16.25"  
W98cm D98cm H63cm SH41cm

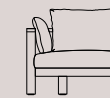

Corner 01201

W38.5" D38.5" H24.75" SH16.25"  
W98cm D98cm H63cm SH41cm

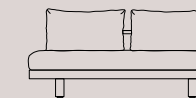

Extension 01228

W74.75" D38.6" H24.75" SH16.25"  
W190cm D98cm H63cm SH41cm

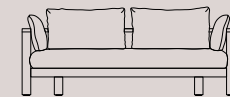

2-Seater sofa 01207

W78.7" D38.6" H24.8" SH16.25"  
W200cm D98cm H63cm SH41cm

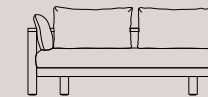

Right arm 01204

W76" D38.6" H24.8" SH16.25"  
W193cm D98cm H63cm SH41cm

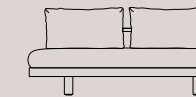

Left arm 01203

W76" D38.6" H24.8" SH16.25"  
W193cm D98cm H63cm SH41cm

**SURO**

CHRISTOPHE DELCOURT

P. 14-15

The Suro Banquette truly enhances the combination of two materials: the elegant rigor of teak wood or powder coated aluminium and the flexibility of the braided rope weaving. Both materials elegantly blend into an exceptional design. The wood and aluminium both affirm the structure of the seat. The fiber backrest, as if hanging from the seat, forms an embracing cocoon-like flower petal which provides unique comfort thanks to its roundness.



Code 02708

W64.25" D34.25" H29.5" SH17.25"  
W163cm D87cm H75cm SH44cm

T - TEAK

**FRAME**



20 - CLAY

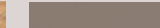

12 - HEMP

10 - LINEN

**WEAVE**





**SOFAS**



**NODI**

YABU PUSHELBERG

P. 12-13, 16-17, 28-29, 30-31, 35, 42-43, 49, 50, 54-55, 104-105

The modular Nodi sofa has a strong personality, yet it sits easily in an outdoor space without dominating it. The frame has an airiness and architectural appeal thanks to its curve, grace and open weaving. The extra-soft cushion filling makes Nodi one of the most comfortable outdoor sofas, as well as one of the most flexible. With three seating elements and four seat depths you can create your own personal sofa.

	00 - WHITE	89 - WENGÉ
<b>FRAME</b>		
	00/10 - WHITE/LINEN	10 - LINEN
<b>WEAVE</b>		

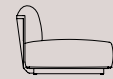

**Regular**  
37.5"  
95cm

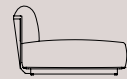

**Deep**  
44"  
112cm



**Lounge**  
59"  
150cm



**Meridienne**  
70.75"  
180cm



**Pouf regular 01955**  
W34,25" D34,25" SH15"  
W87cm D87cm SH38cm

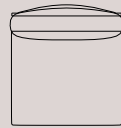

**Single module regular 01950**  
W34,25" D37.5" H31.1" SH15" SD26.8"  
W87cm D95cm H79cm SH38cm SD68cm

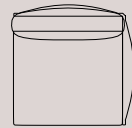

**Corner module regular single back cushion left arm 01951**  
W37" D37.5" H31.1" SH15" SD26.8"  
W94cm D95cm H79cm SH38cm SD68cm

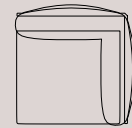

**Corner module regular corner back cushion left arm 01953**  
W37" D37.5" H31.1" SH15" SD26.8"  
W94cm D95cm H79cm SH38cm SD68cm

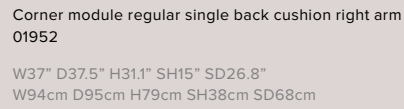

**Corner module regular single back cushion right arm 01952**  
W37" D37.5" H31.1" SH15" SD26.8"  
W94cm D95cm H79cm SH38cm SD68cm



**Corner module regular corner back cushion right arm 01954**  
W37" D37.5" H31.1" SH15" SD26.8"  
W94cm D95cm H79cm SH38cm SD68cm



**Pouf deep 01965**  
W34,25" D40.5" SH15"  
W87cm D103cm SH38cm

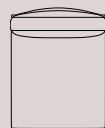

**Single module deep 01960**  
W34,25" D44" H31.1" SH15" SD34.2"  
W87cm D112cm H79cm SH38cm SD87cm

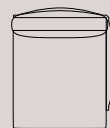

**Corner module deep single back cushion left arm 01961**  
W37" D44" H31.1" SH15" SD34.2"  
W94cm D112cm H79cm SH38cm SD87cm

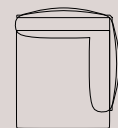

**Corner module deep corner back cushion left arm 01963**  
W37" D44.1" H31.1" SH15" SD34.2"  
W94cm D112cm H79cm SH38cm SD87cm

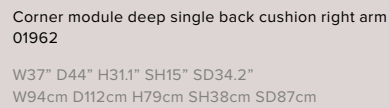

**Corner module deep single back cushion right arm 01962**  
W37" D44" H31.1" SH15" SD34.2"  
W94cm D112cm H79cm SH38cm SD87cm



**Corner module deep corner back cushion right arm 01964**  
W37" D44.1" H31.1" SH15" SD34.2"  
W94cm D112cm H79cm SH38cm SD87cm

**SOFAS**



**Pouf lounge 01975**  
W34,25" D56,25" SH15"  
W87cm D143cm SH38cm



**Lounge daybed 01970**  
W34,25" D59.1" H31" SH15" SD47.2"  
W87cm D150cm H79cm SH38cm SD120cm



**Lounge corner single back cushion left arm 01971**  
W37" D59" H31" SH15" SD47.2"  
W94cm D150cm H79cm SH38cm SD120cm

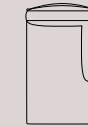

**Lounge corner corner back cushion left arm 01973**  
W37" D59" H31" SH15" SD47.2"  
W94cm D150cm H79cm SH38cm SD120cm

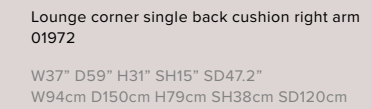

**Lounge corner single back cushion right arm 01972**  
W37" D59" H31" SH15" SD47.2"  
W94cm D150cm H79cm SH38cm SD120cm

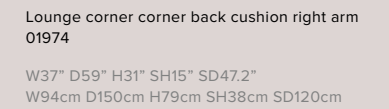

**Lounge corner corner back cushion right arm 01974**  
W37" D59" H31" SH15" SD47.2"  
W94cm D150cm H79cm SH38cm SD120cm



**Pouf XL 01985**  
W34" D70.7" SH15"  
W86,5cm D173cm SH38cm



**Meridienne daybed 01980**  
W34,25" D70,75" H31,1" SH15" SD60,2"  
W87cm D180cm H79cm SH38cm SD153cm



**Meridienne corner single back cushion left arm 01981**  
W37" D70,75" H31" SH15" SD60,2"  
W94cm D180cm H79cm SH38cm SD153cm



**Meridienne corner corner back cushion left arm 01983**  
W37" D70,75" H31" SH15" SD60,2"  
W94cm D180cm H79cm SH38cm SD153cm

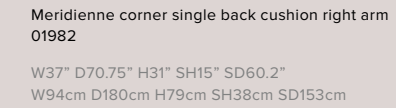

**Meridienne corner single back cushion right arm 01982**  
W37" D70,75" H31" SH15" SD60,2"  
W94cm D180cm H79cm SH38cm SD153cm

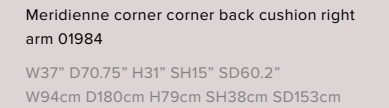

**Meridienne corner corner back cushion right arm 01984**  
W37" D70,75" H31" SH15" SD60,2"  
W94cm D180cm H79cm SH38cm SD153cm



**SOFAS**

**NATAL ALU**

STUDIO SEGERS

P. 122-123, 124-125

A subtle frame with attractive, curved armrests contrasts beautifully with the volume of the outdoor cushions which are supported by a weave in broad textile straps. Thirteen different modules compose the outdoor sofa of your liking. The aluminium frame of the sofa is powder-coated with ultra durable structure lacquer. The outdoor cushions can be left outside, even in the rain. The ventilating filling is covered with a laminated polypropylene cover which is water resistant. All stitches have an extra inside cover to prevent water from penetrating.

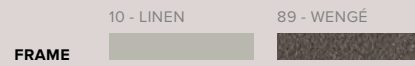

**SOFAS**

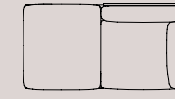

**Meridienne right 05803**  
W39" D74" H23.5" SH16.5"  
W99cm D188cm H60cm SH42cm

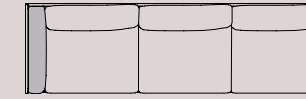

**Right arm extension 3-seat 05839RS/05839RD**  
W107" H23.5" SH16.5"  
W272cm H60cm SH42cm

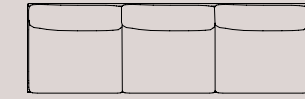

**Left arm extension 3-seat 05839LS/05839LD**  
W107" H23.5" SH16.5"  
W272cm H60cm SH42cm

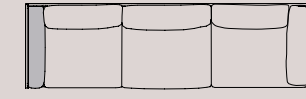

**Right arm corner module 3-seat 05849RS/05849RD**  
W107" H23.5" SH16.5"  
W272cm H60cm SH42cm

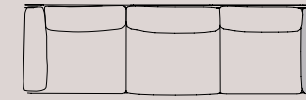

**Left arm corner module 3-seat 05849LS/05849LD**  
W107" H23.5" SH16.5"  
W272cm H60cm SH42cm

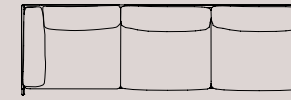

**Right corner extension 3-seat 05859RS/05859RD**  
W107" H23.5" SH16.5"  
W272cm H60cm SH42cm

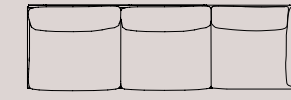

**Left corner extension 3-seat 05859LS/05859LD**  
W107" H23.5" SH16.5"  
W272cm H60cm SH42cm

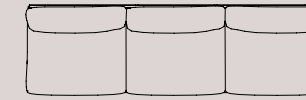

**Centre module 3-seat 05829S/05829D**  
W107" H23.5" SH16.5"  
W272cm H60cm SH42cm

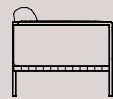

**Regular**  
32"  
81cm

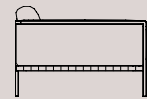

**Deep**  
41.25"  
105cm

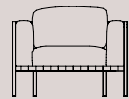

**armchair 05802**  
W36.5" D32" H23.5" SH16.5"  
W93cm D81cm H60cm SH42cm

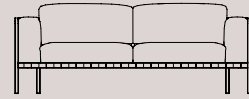

**2-seat sofa 05808S/05808D**  
W74.5"/73.25" H23.5" SH16.5"  
W189cm/186cm H60cm SH42cm

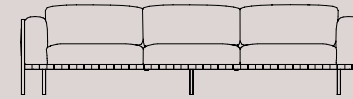

**3-seat sofa 05809S/05809D**  
W107.5" H23.5" SH16.5"  
W273cm H60cm SH42cm

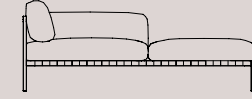

**Meridienne left 05868**  
**Meridienne right 05869**  
W39" D74" H23.5" SH16.5"  
W99cm D188cm H60cm SH42cm

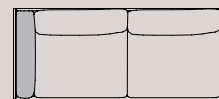

**Right arm extension 2-seat 05838RS/05838RD**  
W74" H23.5" SH16.5"  
W188cm H60cm SH42cm

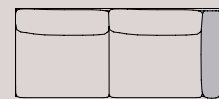

**Left arm extension 2-seat 05838LS/05838LD**  
W74" H23.5" SH16.5"  
W188cm H60cm SH42cm

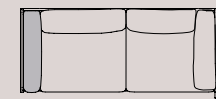

**Right arm corner module 2-seat 05848RS/05848RD**  
W74" H23.5" SH16.5"  
W188cm H60cm SH42cm

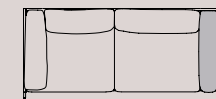

**Left arm corner module 2-seat 05848LS/05848LD**  
W74" H23.5" SH16.5"  
W188cm H60cm SH42cm



**Right corner extension 2-seat 05858RS/05858RD**  
W74" H23.5" SH16.5"  
W188cm H60cm SH42cm

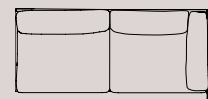

**Left corner extension 2-seat 05858LS/05858LD**  
W74" H23.5" SH16.5"  
W188cm H60cm SH42cm

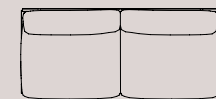

**Centre module 2-seat 05828S/05828D**  
W74" H23.5" SH16.5"  
W188cm H60cm SH42cm

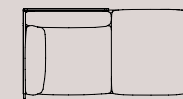

**Meridienne left 05803**  
W39" D74" H23.5" SH16.5"  
W99cm D188cm H60cm SH42cm



**SOFAS**

**VIS A VIS**

PIERGIORGIO CAZZANIGA

P. 41, 46-47, 81, 84-85, 131, 186-187, 195

Slender, teak platforms support comfortable outdoor cushions without any visible back or arm structure. Tribù uses only the very best plantation wood from East-Java. Every log is handpicked during the cutting process of the tree. The cushions are supported by brackets in stainless steel 304L and can be left outside, even in the rain. The ventilating filling is covered with a waterproof, laminated polypropylene cover which is water resistant. All stitches have an extra inside cover to prevent water from penetrating. The simple, modular system allows for endless compositions from a small meridienne sofa to a large corner sofa with side tables.

TEAK

FRAME



**SOFAS**

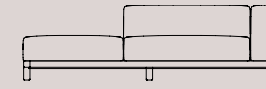

**Meridienne right long arm 01704**  
W39" D78" H24.8" SH16.25"  
W198cm D99cm H63cm SH41cm

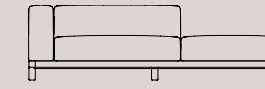

**Meridienne left long arm 01703**  
W39" D78" H24.8" SH16.25"  
W198cm D99cm H63cm SH41cm

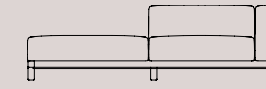

**Meridienne right short arm 01704s**  
W39" D78" H24.8" SH16.25"  
W198cm D99cm H63cm SH41cm

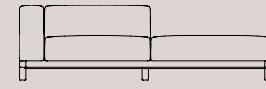

**Meridienne left short arm 01703s**  
W39" D78" H24.8" SH16.1"  
B 198cm D99cm H63cm SH41cm

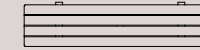

**Border small 01796B**  
W39" D8.5" H7.1"  
W99cm D21,5cm H18cm



**Border large 01797B**  
W47.6" D8.5" H7.1"  
W121cm D21,5cm H18cm

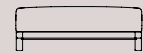

**Pouf module 01792**  
W39" D39" SH16.25"  
W99cm D99cm SH41cm

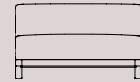

**Extension module single 01700**  
W39" D39" H24.75" SH16.25"  
W99cm D99cm H63cm SH41cm

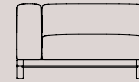

**Corner module right arm 01701R**  
W39" D39" H24.75" SH16.25"  
W99cm D99cm H63cm SH41cm

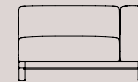

**Corner module left arm 01701L**  
W39" D39" H24.75" SH16.25"  
W99cm D99cm H63cm SH41cm

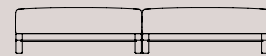

**Centre module 01708**  
W78" D39" H24.8" SH16.25"  
W198cm D99cm H63cm SH41cm

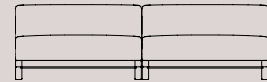

**Extension module double 01728**  
W78" D39" H24.75" SH16.25"  
W198cm D99cm H63cm SH41cm

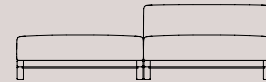

**Extension pouf right 01706R**  
W78" D39" H24.75" SH16.25"  
W198cm D99cm H63cm SH41cm

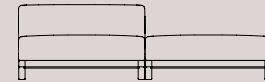

**Extension pouf left 01706L**  
W78" D39" H24.75" SH16.25"  
W198cm D99cm H63cm SH41cm

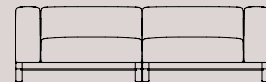

**2-seater sofa 01709**  
W78" D39" H24.75" SH16.25"  
W198cm D99cm H63cm SH41cm



**Right arm module 01738R**  
W78" D39" H24.75" SH16.25"  
W198cm D99cm H63cm SH41cm



**Left arm module 01738L**  
W78" D39" H24.75" SH16.25"  
W198cm D99cm H63cm SH41cm



**Daybed module 01742**  
W78" D39" H24.75" SH16.25"  
W198cm D99cm H63cm SH41cm



**SOFAS**

**SENJA**

STUDIO SEGERS

P. 62-63, 66-67.

Curl up and relax on the modular Senja sofa. Combine a one-, two- or three-seater module with high or low arms and keep everything you need to hand with an integrated table, console or side table in teak or glazed lava stone. Senja comes with regular seat cushions or an ultra-deep variant to curl up on. With a choice of 110 weather-resistant fabrics, Senja lets you create the sofa you want, tailored to your personal style.

	10-LINEN	89 - WENGÉ	
<b>FRAME</b>			
	10 - LINEN	89 - WENGÉ	TEAK
<b>LEGS</b>			
	L10 - LINEN	L70 - OCEAN	TEAK
<b>TOPS</b>			

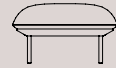

**Regular (R)**  
28.75"  
73cm

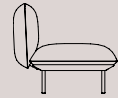

**Regular (R)**  
36.25"  
92cm

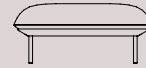

**Deep (D)**  
38.2"  
97cm

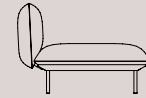

**Deep (D)**  
45.75"  
116cm

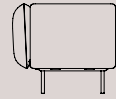

**High armrest (HA)**  
30.3"  
77cm

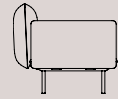

**Low armrest (LA)**  
24.4"  
62cm

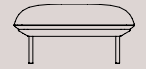

**Pouf module R 023200**  
W33.75" H16.5" SH15.25"  
W86cm H42cm SH39cm

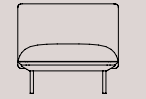

**Single module R 023201**  
W33.75" H30.3" SH15.25"  
W86cm H77cm SH39cm

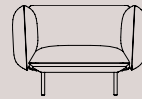

**1-seater sofa RHA 023202/RLA 023203**  
W48"/47.25" H30.3"/24.5" SH15.25"  
W122/120cm H77cm/62cm SH39cm

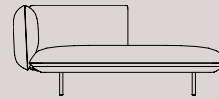

**Meridienne left deep DHA 023301/DLA 023302**  
**Meridienne right deep DHA 023401/DLA 023402**  
W73.2" D45.7" H30.3"/24.5" SH15.25"  
W186cm D116cm H77cm/62cm SH39cm

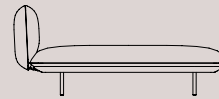

**Meridienne Daybed deep 023403**  
W73.2" D45.7" H30.3"/24.5" SH15.25"  
W186cm D116cm H77cm/62cm SH39cm

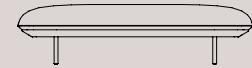

**Double pouf module R 023801/D023851**  
W66.75" H16.5" SH15.25"  
W167cm H42cm SH39cm

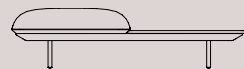

**Pouf+table R 023802/D023852**  
W65.75" H16.5" SH15.25"  
W167cm H42cm SH39cm

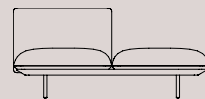

**Single module + pouf R 023803/D023853**  
W66.75" H30.3" SH15.25"  
W167cm H77cm SH39cm

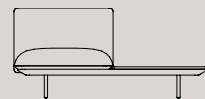

**Single module + table R 023804/D023854**  
W66.75" H30.3" SH15.25"  
W167cm H77cm SH39cm

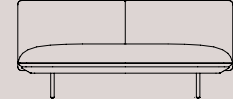

**Double module R 023805/D023855**  
W65.75" H30.3" SH15.25"  
W167cm H77cm SH39cm

**SOFAS**

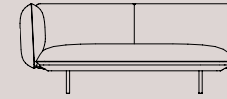

**Right corner RHA 023806/ RLA 023808**  
**Left corner RHA 023807/ RLA 023809**  
**Right corner DHA 023856/DLA 023858**  
**Left corner DHA 023857/DLA 023859**  
W73.2"/72.8" H30.3"/24.5" SH15.25"  
W186/185cm H77cm/62cm SH39cm

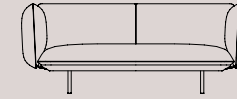

**2-seater sofa RHA 023810/RLA 023811**  
**2-seater sofa DHA 023860/DLA 023861**  
W80.3"/79.5" H30.3"/24.5" SH15.25"  
W204/202cm H77cm/62cm SH39cm

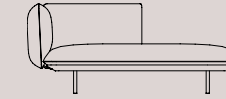

**Right corner + pouf RHA 023814/ RLA 023816**  
**Left corner + pouf RHA 023815/ RLA 023817**  
**Right corner + pouf DHA 023864/DLA 023866**  
**Left corner + pouf DHA 023865/DLA 023867**  
W73.2"/72.8" H30.3"/24.5" SH15.25"  
W186/185cm H77cm/62cm SH39cm

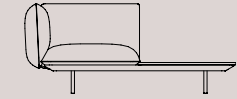

**Right corner + table RHA 023818/ RLA 023820**  
**Left corner + table RHA 023819/ RLA 023821**  
**Right corner + table DHA 023868/DLA 023870**  
**Left corner + table DHA 023869/DLA 023871**  
W73.2"/72.8" H30.3"/24.5" SH15.25"  
W186/185cm H77cm/62cm SH39cm

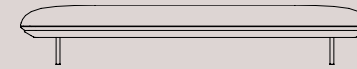

**Triple pouf module R 023901/D023951**  
W99.2" H15.25" SH15.25"  
W253cm H39cm SH39cm

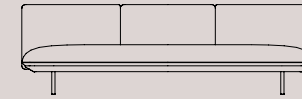

**Triple module R 023902/D023952**  
W99.2" H30.3" SH15.25"  
W253cm H77cm SH39cm

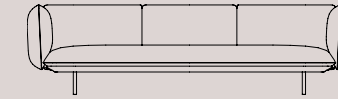

**3-seater sofa R 023903/D023953**  
W113.4"/112.6" H30.3"/24.5" SH15.25"  
W288/286cm H77cm/62cm SH39cm

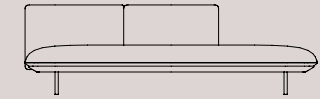

**Right extension+pouf R 023907/D023957**  
**Left extension+pouf R 023908/D023958**  
W99.2" H30.3" SH15.25"  
W253cm H77cm SH39cm

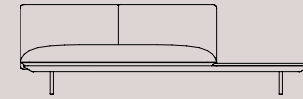

**Right extension+table R 023909/D023959**  
**Left extension+table R 023910/D023960**  
W99.2" H30.3" SH15.25"  
W252cm H77cm SH39cm

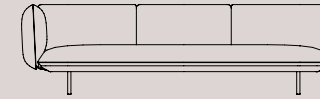

**Right corner RHA 023911/ RLA 023913**  
**Left corner RHA 023912/ RLA 023914**  
**Right corner DHA 023961/DLA 023963**  
**Left corner DHA 023962/DLA 023964**  
W106.3"/105.9" H30.3"/24.5" SH15.25"  
W270/269cm H77cm/62cm SH39cm"

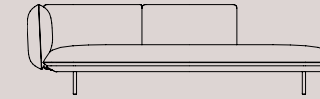

**Right corner + pouf RHA 023915/ RLA 023917**  
**Left corner + pouf RHA 023916/ RLA 023918**  
**Right corner + pouf DHA 023965/DLA 023967**  
**Left corner + pouf DHA 023966/DLA 023968**  
W106.3"/105.9" H30.3"/24.5" SH15.25"  
W270/269cm H77cm/62cm SH39cm

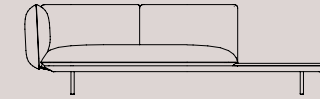

**Right corner + table RHA 023919/ RLA 023921**  
**Left corner + table RHA 023920/ RLA 023922**  
**Right corner + table DHA 023969/DLA 023971**  
**Left corner + table DHA 023970/DLA 023972**  
W106.3"/105.9" H30.3"/24.5" SH15.25"  
W270/269cm H77cm SH39cm



# LOUNGE CHAIRS

## LOUNGE CHAIRS



### AMANU

YABU PUSHELBERG

P. 25, 28-29, 31, 33, 35, 122, 125

The refined Amanu collection brings interior quality outside, combining comfort and sustainability. The chairs feature woven, hemp-based Canax® sling seats that seem to float from a slimline-teak frame, sourced from sustainably managed Indonesian plantations. The slightly tapered legs provide lightness and grace, while the smooth, half-rounded armrests and the elegantly finished cushions make the chairs extremely comfortable.

Code 02612

W30" D32.75" H32.75" SH15.25"  
W76cm D83cm H83cm SH39cm

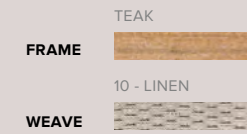

### SURO

CHRISTOPHE DELCOURT

P. 7, 8-9, 12-13, 14-15, 16-17, 173

The Suro lounge chair truly enhances the combination of two materials: the elegant rigor of teak wood or powder coated aluminium and the flexibility of the braided rope weaving. Both materials elegantly blend into an exceptional design. The wood and aluminium both affirm the structure of the seat. The fiber backrest, as if hanging from the seat, forms an embracing cocoon-like flower petal which provides unique comfort thanks to its roundness.

Code 02712

W28" D29.5" H29.25" SH15.75"  
W71cm D75cm H74cm SH40cm

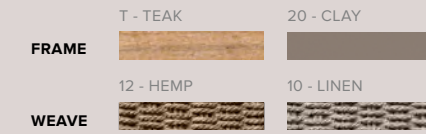

### UKIYO

MONICA ARMANI

P. 37, 40, 42, 46

Curved lines like brushstrokes, precise and ethereal at the same time, also incorporated into the Japanese writing system, were the inspiration for the new Ukiyo collection. The Ukiyo lounge expresses the delicacy of brushstrokes while offering unmatched comfort.

Code 07512

W28.25" D28.75" H27.5" SH16.5"  
W72cm D73cm H70cm SH42cm

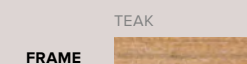

### SENJA

STUDIO SEGERS

P. 59, 62-63, 66, 68-69, 190-191

The rhythm of Senja's tightly stretched weaving in hemp-based Canax® perfectly blends form and function, beauty and comfort. The gentle angle of the generous backrest supports and moulds to the spine, with added depth from the extended seat and softness from the cushions..

Code 02312

W27.25" D30.25" H28.75" SH17"  
W69cm D77cm H73cm SH43cm





## LOUNGE CHAIRS

### ELIO HIGH BACK

YABU PUSHELBERG

P. 71

Elio, referring to the Greek sun god Helios and designed by Canadian design firm Yabu Pushelberg, is inspired by the motion of light as it reflects and refracts on landscapes and objects. Multiple soft shades of yarn are woven into one strand, which mimics the hues of natural light and makes each chair unique. The handwoven seat in weather-resistant Tricord rope, draws inward to create a warm, intimate cocoon effect. The high back, deep seat and generous cushion make it perfect for daydreaming. The chair is framed by natural teak, which supports the seating shell primarily through the back legs that cross the shell.

Code 02520

W28" D34.75" H39.75" SH15"  
W71cm D88cm H101cm SH38cm

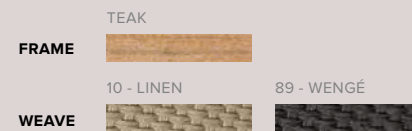
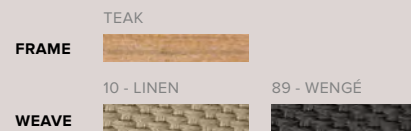

### NOMAD

MONICA ARMANI

P. 55, 91, 102-103, 104-105

The deep cushion of the Nomad lounge chair is stitched to cocoon the body, folding over the armrests and moulding into the broad curve of the backrest. Designer Monica Armani used what she calls 'noble teak wood' for its warmth, smoothness and strength. Slender legs and contoured armrests give the chair its elegant profile and the smartly stitched cushion is as luxurious as it is comfortable. Nomad, like its name, works well wherever it is placed, in combination with a lounge set-up or as a stand-alone piece.

Code 05012

W29.25" D28" H27.5" SH17.25"  
W74cm D71cm H70cm SH44cm

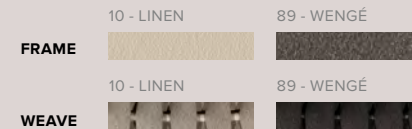
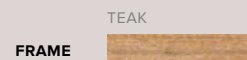

### ELIO

YABU PUSHELBERG

P. 72-73, 75, 118

Elio, referring to the Greek sun god Helios and designed by Canadian design firm Yabu Pushelberg, is inspired by the motion of light as it reflects and refracts on landscapes and objects. Multiple soft shades of yarn are woven into one strand, which mimics the hues of natural light and makes each chair unique. The handwoven seat in weather-resistant Tricord rope, draws inward to create a warm, intimate cocoon effect. The lounge chair is framed by natural teak, which supports the seating shell primarily through the back legs that cross the shell.

Code 02512

W26.5" D30" H31.5" SH16.5"  
W67cm D76cm H80cm SH42cm

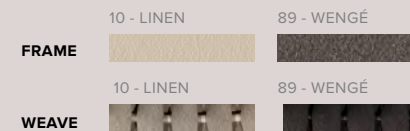

### TOSCA LOW DINING

MONICA ARMANI

P. 92-93

The Tosca deep-seated low dining chair adds low-key luxury to relaxed dining. The elegant seating shell in powder-coated stainless steel is upholstered with an extra-large, vertical weave. The material is genuinely innovative, a combination of textilene and polyolefin is knitted over a tube of EPDM foam without any visible joint. Next to its weather-resistant features, the material is also surprisingly soft to the touch. The ton-sur-ton colours emphasise the chic character of this lounge chair and the comfortable outdoor cushions guarantee a pleasant seating comfort.

Code 05317

W26.75" D26.75" H24" SH17"  
W68cm D68cm H61cm SH43cm

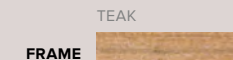

## LOUNGE CHAIRS

### TOSCA

MONICA ARMANI

P. 89, 90

The Tosca outdoor collection is simultaneously warm and inviting, stylish and intriguing. It was the first time Tribù called upon a female designer to draw an outdoor furniture piece with a more feminine touch. Monica Armani succeeded in her challenge: rounded forms, tapered legs and an elegant seating shell in powder-coated stainless steel, upholstered with extra-wide braiding. The material for the braiding is genuinely innovative: foam mousse is encased in a seamless sheath of knitted Textilene® and polyolefine which makes the material weather-resistant, but also surprisingly soft to the touch. The seating comfort is especially pleasant, also thanks to the comfortable outdoor cushions.

Code 05302

W34.75" D29.25" H30.75" SH15.75"  
W88cm D74cm H78cm SH40cm

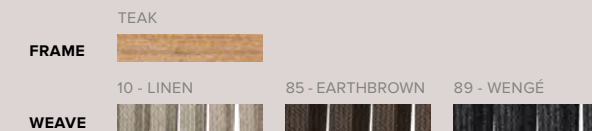

### MOOD

STUDIO SEGERS

P. 115, 116-117

The airy design of the Mood collection and its warm combination of teak and handwoven backs will immediately create an intimate atmosphere on your patio. The rounded design of the durable teak gives the lounge chair a warm and friendly tone. The weave in Tricord has a very soft touch, but can nevertheless defy all weather conditions. Tribù has developed a range of natural colours that fit in with any type of outdoor environment. The comfortable outdoor cushions can be left out in the rain, thanks to the ventilating, water-repellent filling.

Code 06202

W35.75" D32" H27.25" SH17"  
W91cm D81cm H69cm SH43cm

### PURE

ANDREI MUNTEANU

With the Pure Sofa, designer Andrei Munteanu reduces design to the essence, devoid of all excess: pure simplicity and elegance. This modular outdoor sofa consists of five elements that combine easily into a corner sofa, long couch, lounge bed, etc. The sofa is available in high-quality teak from Indonesian plantations. Deep casual cushions to sink into create an informal, relaxed look and are available in numerous luxury outdoor fabrics. In addition to casual cushions, the Pure sofa armchair is also available with Miami cushions.

Code 01202S

W36.5" D38.5" H24.75" SH16.25"  
W93cm D98cm H63cm SH41cm

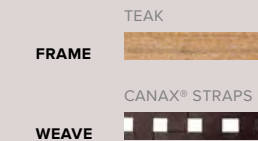

### VIS À VIS

PIERGIORGIO CAZZANIGA

The Vis à vis collection gives wooden outdoor furniture a new dimension. Teak is designer Cazzaniga's favourite outdoor material, it is natural, soft to touch and extremely durable. When he started to design the collection, he thought of a place where people could be outside and communicate with each other in total comfort. The result was a lounge with royal dimensions and an integrated side table, designed in a way that two loungers fit into each other.

Code 01712

W28" D28.25" H30" SH16.5"  
W71cm D72cm H76cm SH42cm

Code rocking chair 01713

W24.5" D32.25" H29.5" SH16.25"  
W62cm D82cm H75cm SH41cm



LOUNGE CHAIRS

NATAL ALU

STUDIO SEGERS



The Natal Alu collection combines functionality with impeccable class and a strong charisma. The straight, angular lines of the aluminium frame contrast beautifully with the curved seat in Batyline® which seems to float within the frame. In 1999, the stainless steel version with teak seat won a Henry van de Velde design award. Today the design is still very much in style, although updated with more low-maintenance materials. Batyline is UV and stretch-resistant, dirt-repellent and quick-drying.

Code 05912

W22.75" D27.5" H28.25" SH15.25"  
W58cm D70cm H72cm SH39cm



NODI

YABU PUSHHELBERG

P. 51, 188

Light and airy, Nodi's silhouette is characterised by twisted-interlaced rope in weather-resistant Canax®, stretched across a precise geometric wireframe. Refined proportions and a minimalist approach to materiality lend a casual lightness to the collection. The slim profile of the arm is angled slightly inward in a welcoming gesture. The open weave in Canax®, a combination of PVC and natural hemp, crosses in vertical and horizontal lines, providing shape and structure to the seat and back.

Code 01912

W23.5" D28.25" H28" SH14.5"  
W60cm D72cm H71cm SH37cm

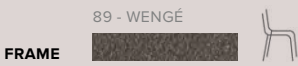

CTR

PIERGIORGIO CAZZANIGA

P. 130-131, 132-133, 174-175



Italian designer Piergiorgio Cazzaniga does with the CTR collection what he is good at: making complex designs appear effortless. The frame of the chair is made of profiles in powder-coated stainless steel that are bent in one continuous line. The corners are straight, yet the tubes keep a round form, which requires great mastery. The backrest is attached to the frame at only 2 points and appears to float unsuspected above the seat. The open weave refers to the ancient tradition of weaving and gives flexible support to the back.

Code 01102

W31" D30.25" H30" SH17.75"  
W79cm D77cm H76cm SH45cm

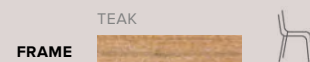
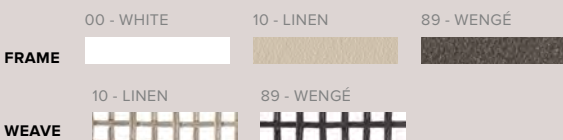

KOS

STUDIO SEGERS

P. 146-147



Basic chic with an excellent, well-studied seating comfort is the best way to describe the Kos collection. The combination of the broad slats and the pure but powerful design, reinvents teak in a modern, robust way. Tribù uses only the very best Javanese plantation wood for its teak outdoor furniture. Its quality is locally controlled by subsidiary Tribù Asia.

Code 04012

W24" D27.5" H28.25" SH15.25"  
W61cm D70cm H72cm SH39cm



# CHAIRS

## CHAIRS



### AMANU

YABU PUSHELBERG

P. 26-27, 34

The refined Amanu collection brings interior quality outside, combining comfort and sustainability. The chairs feature woven, hemp-based Canax® sling seats that seem to float from a slimline-teak frame, sourced from sustainably managed Indonesian plantations. The slightly tapered legs provide lightness and grace, while the smooth, half-rounded armrests and the elegantly finished cushions make the chairs extremely comfortable.

Code 02618

W24" D24.5" H33" SH19"  
W 61 D62cm H84cm SH48cm

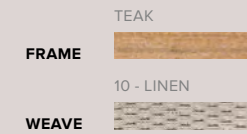

### SURO

CHRISTOPHE DELCOURT

P. 10-11, 18-19, 21, 22-23,

The Suro armchair truly enhances the combination of two materials: the elegant rigor of teak wood or powder coated aluminium and the flexibility of the braided rope weaving. Both materials elegantly blend into an exceptional design. The wood and aluminium both affirm the structure of the seat. The fiber backrest, as if hanging from the seat, forms an embracing cocoon-like flower petal which provides unique comfort thanks to its roundness.

Code 02718

W24" D24.5" H32.75" SH20"  
W61cm D62cm H83.5cm SH50.6cm

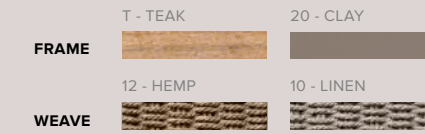

### UKIYO

MONICA ARMANI

P. 38-39

When visiting Japan designer Monica Armani was inspired by the signs and the sophisticated Japanese culture, especially the eye for detail which also describes her design aesthetic. For the Ukiyo armchairs, she worked on the balance between curved and taut lines and the visual weight of each element that concludes an armchair that's comfortable, elegant and exudes pure design.

Code 07518

W24" D23.25" H32.75" SH19.75"  
W61cm D59cm H83cm SH50cm

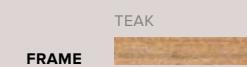

### SENJA

STUDIO SEGERS

P. 60-61

The rhythm of Senja's tightly stretched weaving in hemp-based Canax® perfectly blends form and function, beauty and comfort. The gentle angle of the backrest supports and moulds to the spine, with added depth and softness from the cushions.

Code 02318

W23.25" D26" H31.5" SH19.75"  
W59cm D66cm H80cm SH50cm





CHAIRS

## NOMAD

MONICA ARMANI

P. 101



The NOMAD armchair emphasises the unique characteristics of teak wood, one being able to sculpt it, like few other kinds of wood. Having extensive knowledge and experience in teak processing, Tribù was able to guide designer Monica Armani from concept to a final design, balancing soft shapes, subtle lines, and skill.

Code 05018

W23.5" D22" H30" SH20"  
W60cm D56cm H76cm SH51cm

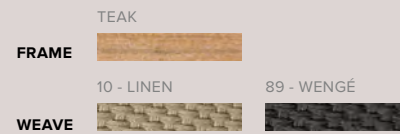
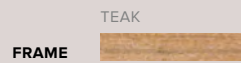

## TOSCA

MONICA ARMANI

P. 94-95, 98-99



The Tosca outdoor collection is simultaneously warm and inviting, stylish and intriguing. It was the first time Tribù called upon a female designer to draw an outdoor furniture piece with a more feminine touch. Monica Armani succeeded in her challenge: rounded forms, tapered legs and an elegant seating shell in powder-coated stainless steel, upholstered with extra-wide braiding. The material for the braiding is genuinely innovative: foam mousse is encased in a seamless sheath of knitted textile and polyolefine which makes the material weather-resistant, but also surprisingly soft to the touch.

Code 05318

W23.25" D25.5" H28" SH19"  
W59cm D65cm H71cm SH48cm

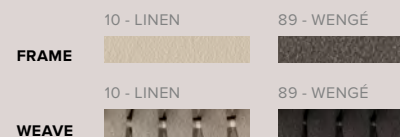
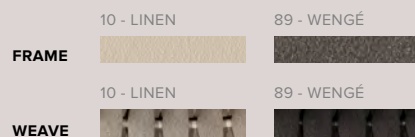

## ELIO

YABU PUSHELBERG

P. 76-77, 78-79



Elio, referring to the Greek sun god Helios and designed by Canadian design firm Yabu Pushelberg, is inspired by the motion of light as it reflects and refracts on landscapes and objects. Multiple soft shades of yarn are woven into one strand, which mimics the hues of natural light and makes each chair unique. The handwoven seat in weather-resistant Tricord rope, draws inward to create a warm, intimate cocoon effect. The chair, perfect for relaxed dining, is framed by natural teak, which supports the seating shell primarily through the back legs that cross the shell.

Code 02518

W21.75" D23.5" H33" SH18"  
W55cm D60cm H84cm SH46cm

## TOSCA COUNTER HEIGHT

MONICA ARMANI



The Tosca counter-height chair is a perfect fit for a pool-house kitchen counter. Or pair it with the Illum counter-height table, which is 13cm lower than a regular bar table for poolside cocktails. The chair's elegant seating shell in powder coated stainless steel is upholstered with an extra-large, vertical weave, developed exclusively by Tribù. A great deal of research resulted in a unique product with a natural and soft appearance, that is nevertheless 100% weatherproof and stain-repellent.

Code 05315

W21.75" D20.75" H35" SH26.5"  
W55cm D53cm H89cm SH67cm

CHAIRS

## CTR

PIERGIORGIO CAZZANIGA

P. 127, 134-135



Italian designer Piergiorgio Cazzaniga does with the CTR collection what he is good at: making complex designs appear effortless. The frame of the chair is made of profiles in powder-coated stainless steel that are bent in one continuous line. The corners are straight, yet the tubes keep a round form, which requires great mastery. The backrest is attached to the frame at only 2 points and appears to float unsuspended above the seat. The open weave refers to the ancient tradition of weaving and gives flexible support to the back. The seat is upholstered with a water-repellent cushion which can be easily removed.

Code 01118

W22.75" D22.5" H30.25" SH19"  
W58cm D57cm H77cm SH48cm

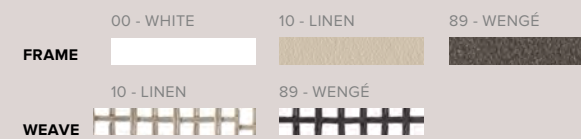

## CTR BAR

PIERGIORGIO CAZZANIGA



Italian designer Piergiorgio Cazzaniga does with the CTR collection what he is good at: making complex designs appear effortless. The frame of the chair is made of profiles in powder-coated stainless steel that are bent in one continuous line. The corners are straight, yet the tubes keep a round form, which requires great mastery. The backrest is attached to the frame at only 2 points and appears to float unsuspended above the seat. The open weave refers to the ancient tradition of weaving and gives flexible support to the back. The seat is upholstered with a water-repellent cushion which can be easily removed.

Code 01116

W22.75" D22.5" H44" SH33.5"  
W58cm D57cm H112cm SH85cm



## BRANCH

LIEVORE ALTHERR MOLINA

P. 137, 140

Inspired by tree branches, the Branch outdoor chair looks fluid and organic. Behind the airy, slimline appearance lies a sophisticated design and well-thought-out materials. The aluminium die-cast frame is powder-coated with a double layer for a superior scratch and uv-resistance. The seat and back are made of polypropylene, reinforced with fibre glass. The seating comfort of the garden chair is extraordinary thanks to the anatomic resilience of the back. Aluminium and polypropylene are excellent outdoor materials, easy to clean, weather-resistant and 100% recyclable. The Branch garden chair is available with armrests or without and is stackable for easy storage.

Code 07618

W23.25" D22.5" H31.5" SH18.5"  
W59cm D57cm H80cm SH47cm



## BRANCH SIDE

LIEVORE ALTHERR MOLINA

P. 137, 138-139, 140-141



Inspired by the branches of a tree, the Branch collection has a sleek, organic look. The idea behind the collection was to design a chair that blends in completely with nature and optimally resists all weather conditions. Behind the slender appearance lies a sophisticated design and a well-considered choice for durable, easy-to-maintain, recyclable materials. The technique of high-pressure injection gives the aluminum frame a firm stability and the resilience of the polypropylene backs ensures excellent seating comfort. The Branch chair is available with or without armrests, both stackable for easy storage.

Code 07610

W21.25" D22.5" H31.5" SH18.5"  
W54cm D57cm H80cm SH47cm





CHAIRS

## MOOD

STUDIO SEGERS

P. 107, 109, 112-113 ,



The airy design of the Mood collection and its warm combination of teak and handwoven backs will immediately create an intimate atmosphere on your patio. The rounded design of the durable teak gives the chair a warm and friendly tone. The weave in Tricord has a very soft touch, but can nevertheless defy all weather conditions. Tribù has developed a range of natural colours that fit in with any type of outdoor environment. The back cushions are available in various styles to match every taste.

Code 06218

W24" D24.5" H31" SH19.25"  
W61cm D62cm H79cm SH49cm

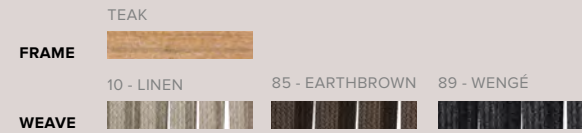

## NATAL ALU

STUDIO SEGERS

P. 121



The Natal Alu collection combines functionality with impeccable class and a strong charisma. The straight, angular lines of the aluminium frame contrast beautifully with the curved seat in Batyline® which seems to float within the frame. In 1999, the stainless steel version with teak seat won a Henry van de Velde design award. Today the design is still very much in style, although updated with more low-maintenance materials. Batyline is UV and stretch-resistant, dirt-repellent and quick-drying. The aluminium frame is corrosion-resistant and has a lovely matte look thanks to the textured powder coating. The chairs are also stackable for easy storage.

Code 05918

W20.75" D20" H33.5" SH19.75"  
W53cm D51cm H85cm SH50cm

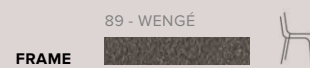

## KOS

STUDIO SEGERS

P. 145



Basic chic with an excellent, well-studied seating comfort is the best way to describe the Kos collection. The combination of the broad slats and the pure but powerful design, reinvents teak in a modern, robust way. Tribù uses only the very best Javanese plantation wood for its teak outdoor furniture. Its quality is locally controlled by subsidiary Tribù Asia.

Code 04018

W21.25" D22.75" H33" SH19.25"  
W54cm D58cm H84cm SH49cm

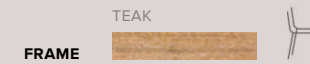

CHAIRS

## KOS BAR

STUDIO SEGERS



Basic chic with an excellent, well-studied seating comfort is the best way to describe the Kos collection. The combination of the broad slats and the pure but powerful design, reinvents teak in a modern, robust way. Tribù uses only the very best Javanese plantation wood for its teak outdoor furniture. Its quality is locally controlled by subsidiary Tribù Asia.

Code 04016

W15.25" D19.75" H41" SH31.5"  
W39cm D50cm H104cm SH80cm

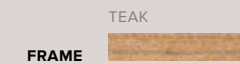

## MOOD BAR

STUDIO SEGERS



The airy design of the Mood collection and its warm combination of teak and handwoven backs will immediately create an intimate atmosphere on your patio. The rounded design of the durable teak gives the bar chair a warm and friendly tone. The weave in Tricord has a very soft touch, but can nevertheless defy all weather conditions. Tribù has developed a range of natural colours that fit in with any type of outdoor environment. The back cushions are available in various styles to match every taste.

Code 06216

W24.5" D23.5" H42.5" SH30.75"  
W62cm D60cm H108cm SH78cm

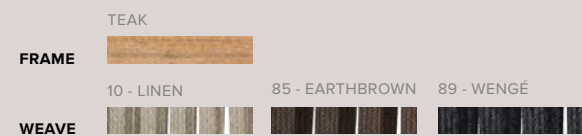

## NODI

YABU PUSHELBERG

P. 52-53



Light and airy, Nodi's silhouette is characterised by twisted-interlaced rope in weather-resistant Canax®, stretched across a precise geometric wireframe. Refined proportions and a minimalist approach to materiality lend a casual lightness to the collection. The slim profile of the arm is angled slightly inward in a welcoming gesture. The open weave in Canax®, a combination of PVC and natural hemp, crosses in vertical and horizontal lines, providing shape and structure to the seat and back. Strong and durable, the rope work is also gently forgiving, adding to the ease and comfort of each chair.

Code 01918

W22.75" D24" H34.25" SH19.75"  
W58cm D61cm H87cm SHcm

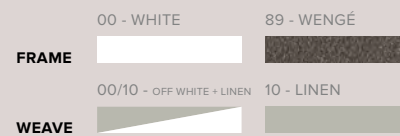

## KOS BENCH

STUDIO SEGERS

P. 145



Basic chic with an excellent, well-studied seating comfort is the best way to describe the Kos collection. The combination of the broad slats and the pure but powerful design, reinvents teak in a modern, robust way. This bench is a casual alternative for chairs at your dining table but serves also perfectly as a stand-alone bench in the garden. Tribù uses only the very best Javanese plantation wood for its teak outdoor furniture. Its quality is locally controlled by subsidiary Tribù Asia.

Code 04034

W77.25" D16.5" H17.75" SH18.5"  
W196cm D42cm H45cm SH47cm

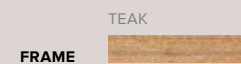



**CHAIRS**

**ILLUM**

MERCKX & MAES

**P. 161, 163, 166-167, 168-169**

The Illum collection refers to the classical Scandinavian furniture archetypes, translated with updated materials for outdoors. Aluminium is used like sculpted wood and Batyline for the seating, serving both looks and durability. Batyline has a lasting high tension and is known to be UV resistant, quick drying and dirt repelling. The soft-curving back of the chair provides an inviting view and seating comfort. Functionality is paramount for Illum, without compromising on comfort and class.

Code 06518

W22" D19.75" H30" SH18.5"  
W56cm D50cm H76cm SH47cm

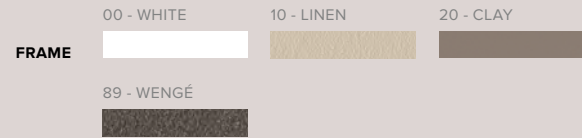

**VIS À VIS**

PIERGIORGIO CAZZANIGA

**P. 64-65**

The Vis à vis collection gives wooden outdoor furniture a sophisticated dimension. Teak is designer Cazzaniga's favourite outdoor material, it is natural, soft to touch and extremely durable. A dining table that can be extended endlessly and a number of highly comfortable chairs make the collection complete. The chairs are upholstered with an airy weave in weather-resistant Canax® and have a subtle rounded profile.

Code 01718

W23.25" D24" H33" SH19.25"  
W59cm D61cm H84cm SH49cm



**ILLUM BENCH**

MERCKX & MAES

**P. 162-163**

The Illum bench is kept pure and simple with beautifully curved profiles complementing the slim legs. The powder-coated aluminium frame is easy to maintain. As for the seat in teak, Tribù uses only the very best teak to be found in Indonesia: A-class wood grown in sustainably managed plantations.

Code 06534

W83.5" D17" H17.75" SH17.75"  
W212cm D43cm H45cm SH45cm

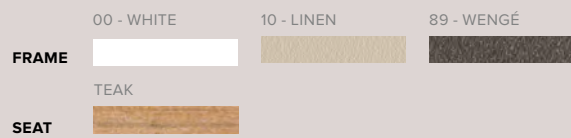

**VIS À VIS BENCH**

PIERGIORGIO CAZZANIGA

**P. 21, 23**

The Vis à Vis collection gives wooden outdoor furniture a new dimension. Teak is designer Cazzaniga's favourite outdoor material. It is natural, soft to touch and extremely durable. While designing, he thought of a place where people could connect in total comfort, outside. This supplementary added bench breathes the basic chic and versatility of the Vis à Vis collection. It is a casual alternative for dining table chairs but serves also perfectly as a stand-alone element.

Code 07134

W62.5" D17.25" H17.25" SH18.50"  
W159cm D44cm H44cm SH47cm

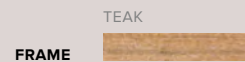



# TABLES

## TABLES

### AMANU

YABU PUSHELBERG

P. 26-27, 34

Exploring the organic beauty and durability of teak, Yabu Pushelberg crafted a dining table that exudes the notion of togetherness. The broad, ceramic tiles seem to float on the discreet, yet sturdy teak frame, creating a remarkable lightness. The rounded edges of both the teak profiles and the outer ceramic tiles, convey a soft and harmonious look that stands out by its simplicity.



Code 02652

L114.25" W38.5" H29.5"  
L290cm W98cm H75cm

Code 02654

L137.8" W38.5" H29.5"  
L350cm W98cm H75cm

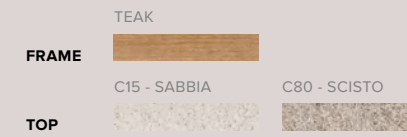

### UKIYO

MONICA ARMANI

P. 38-39, 107

Curved lines like brushstrokes, precise and ethereal at the same time, also incorporated into the Japanese writing system, were the inspiration for the new Ukiyo collection. The Ukiyo low table is the perfect companion to add to any outdoor setting. Different options for the table top in teak or ceramic make this item adjustable for each colour palette.



Code 07553

L106.75" W41" H29.5"  
L271cm W104cm H75cm

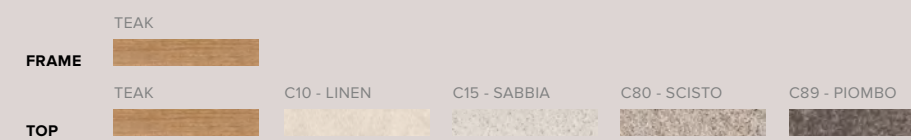



**TABLES**

## OTTO ROUND

MARC MERCKX

**P. 76**

Otto was inspired by a rhythmic 'ribbon' pattern, often found in Italian bar counters from the '40s. Using merely one simple base element, Otto not only significantly preserves the precious teak wood. Like an ancient architectural pillar, the robust yet elegant patterned base supports a floating round tabletop, available in ceramics and natural travertine, making its durable and timeless design versatile to many outdoor settings.

Code 04266

Ø58.25" H29.5"  
Ø148cm H74.7cm

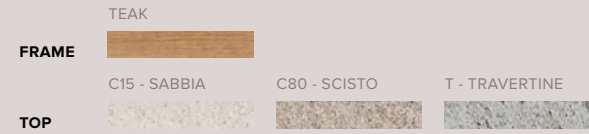

## OTTO RECTANGULAR

MARC MERCKX

**P. 18-19**

Otto was inspired by a rhythmic 'ribbon' pattern, often found in Italian bar counters from the '40s. Using merely one simple base element, Otto not only significantly preserves the precious teak wood. Like ancient architectural pillars, the two robust yet elegant patterned bases support a floating rectangular tabletop, available in ceramics and natural travertine, making its durable and timeless design versatile to many outdoor settings.

Code 04254

L126" W42.25" H29.5"  
L320cm W110cm H74.7cm

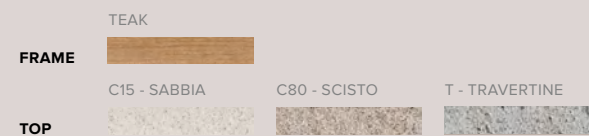

**TABLES**

## SURO

CHRISTOPHE DELCOURT

**P. 20-21, 22-23**

Suro effortlessly meets demands of a shifting lifestyle towards outdoor living. Solid rectangular teak wood slats in different widths characterize the new Suro dining table, affirming its dynamic and contemporary design. This innovative table concept comes in two lengths. Connecting multiple tables together with high quality brass profiles, facilitates endless extension possibilities and truly enhances an exceptional outdoor experience.

Code 02752

L82.75" W43.25" H29.75"  
L210cm W110cm H75.5cm

Code 02753

L110.25" W43.25" H29.75"  
L280cm W110cm H75.5cm



## VIS À VIS

PIERGIORGIO CAZZANIGA

**P. 82-83**

The Vis à Vis table is characterised by solid square slats with slightly rounded corners. The teak is of the best quality you can find. Only A-grade wood, grown in sustainably managed plantations in East Java is used. Every log is handpicked during the cutting process of the tree. The basis of the table concept are tables of 99x99cm that can be attached to each other with invisible profiles to an unlimited length.

Code 01773

L38.9" W38.9" H29.5"  
L99cm W99cm H75cm

Code 01753

L118.1" W38.9" H29.5"  
L300cm W99cm H75cm

Code 01754

L157.5" W38.9" H29.5"  
L400cm W99cm H75cm

Code 01755

L196.8" W38.9" H29.5"  
L500cm W99cm H75cm

From a length of 196.8"/500cm or more, a third leg will be added.

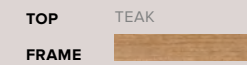



**TABLES**

## KOS

STUDIO SEGERS

**P. 145**

The combination of the broad slats and the pure but powerful design, reinvents teak in a modern way. Tribù uses only the very best plantation wood from East-Java. Every log is handpicked during the cutting process of the tree.

**Code 04073**

L38.6" W38.6" H30"  
L98cm W98cm H76cm

**Code 04052**

L88.2" W39.4" H30"  
L224cm W100cm H76cm

**Code 04053**



L104.7" W39.4" H30"  
L266cm W100cm H76cm

**Code 04054**

L121.3" W43.3" H30"  
L308cm W110cm H76cm

**TOP** TEAK  
**FRAME** 

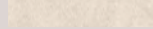
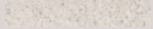

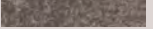
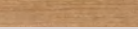
**FRAME**   
**TOP** C10 - LINEN  C15 - SABBIA  C80 - SCISTO  C89 - PIOMBO  TEAK 

**TABLES**

## ILLUM

MERCKX & MAES

**P. 121, 127, 161, 163, 164-165**

The Illum table with its slim legs is kept pure and simple. It is available in two widths: the standard 98 cm and a more narrow version of 71 cm, the ideal solution for smaller patios and balconies. The frame in aluminium has a dual powder coating to guarantee optimal scratch and UV resistance. The ceramic top is coloured in the mass. For the table top in teak Tribù uses only the very best plantation wood from East Java.



**Code 06573**

L39.4" W39.4" H30"  
L100cm W100cm H76cm

**Code 06550**

L59.8" W39.4" H30"  
L152cm W100cm H76cm

**Code 06552**

L83.5" W39.4" H30"  
L212cm W100cm H76cm

**Code 06554**

L105.1" W39.4" H30"  
L267cm W100cm H76cm

**Code 06552xs**







L83.5" W27.9" H30"  
L 212cm W71cm H76cm

**Code 06554xs**

L105.1" W27.9" H30"  
L267cm W71cm H76cm

**FRAME** 00 - WHITE  10 - LINEN  89 - WENGÉ   
**TOP** C10 - LINEN  C15 - SABBIA  C80 - SCISTO  C89 - PIOMBO  TEAK 

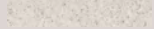

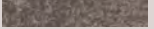
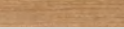
**FRAME** 00 - WHITE  10 - LINEN  89 - WENGÉ   
**TOP** C10 - LINEN  C15 - SABBIA  C80 - SCISTO  C89 - PIOMBO  TEAK 

## ILLUM TEAK

MERCKX & MAES

**P. 78-79**

The teak Illum table maintains the slender proportions of the aluminium version, using the finest teak from carefully managed plantations in East Java. The table top connects with the legs in a smooth curve, the corners being hand-sculpted and sanded from a solid piece of wood. There are no hard edges on this Illum table – all contours are rounded for a soft, pleasing look and feel.

**Code 06573-T**

L39.4" W39.4" H30"  
L100cm W100cm H76cm

**Code 06550-T**

L59.8" W39.4" H30"  
L152cm W100cm H76cm

**Code 06552-T**

L83.5" W39.4" H30"  
L212cm W100cm H76cm

**Code 06554-T**

L105.1" W39.4" H30"  
L267cm W100cm H76cm

**Code 06552xs -T**

L83.5" W28.7" H30"  
L 212cm W73cm H76cm

## ILLUM COUNTER HEIGHT

MERCKX & MAES

The Illum table with its slim legs is kept pure and simple. It is available in two widths: the standard 98 cm and a more narrow version of 71 cm, the ideal solution for smaller patios and balconies. The frame in aluminium has a dual powder coating to guarantee optimal scratch and UV resistance. The ceramic top is coloured in the mass. For the table top in teak Tribù uses only the very best plantation wood from East Java.

**Code 06560 - counterheight**

L59.8" W39.4" H36.5"  
L152cm W100cm H93cm

**Code 06564xs - counterheight**

L83.5" W28" H36.5"  
L212cm W71cm H93cm



**TABLES**

## TOSCA DINING / LOW DINING

MONICA ARMANI

**P. 92-93**

To complete the exclusive Tosca collection, Monica Armani designed a refined dining table with the same elegant, tapered legs and a ceramic table top with a unique oval shape. It is the perfect combination of technical perfection and sophisticated beauty. The ceramic, adorned with a subtle pattern, is laminated on glass, water-jetted in an oval shape and then CNC-milled. Ceramic is an ideal outdoor material, as it is completely UV-resistant, frostproof, extremely scratchproof and completely stain-repellent, not to mention easy to maintain.

Code 05354  
L117,3" W38.5" H29.25"  
L298cm W98cm H74cm

Code 05355  
L94,5" W38.5" H29.25"  
L240cm W98cm H74cm

Code 05335  
L117,3" W38.5" H26,4"  
L298cm W98cm H67cm

Code 05334  
L94,5" W38.5" H26,4"  
L240cm W98cm H67cm

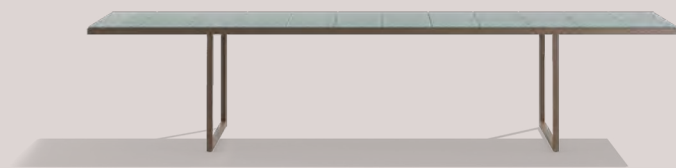
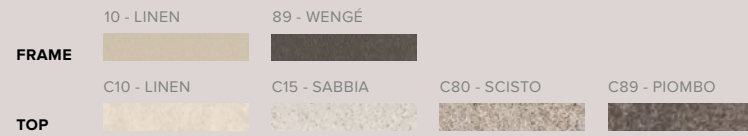

## NOX

TRIBÙ STUDIO

**P. 10-11, 60-61, 98-99, 134-135**

The elegant Nox table features a top from handcrafted glazed lava stone. The stone's reflective nature and natural imperfections add a unique quality to the table. Once glazed, the stone is heat, water, UV and stain resistant. Despite the heavy stone top, the table has a slender structure thanks to the strength of the durable frame in powder-coated stainless steel.

Code 02252  
L103.9" W39" H29.25"  
L264cm W99cm H74cm

Code 02254  
L 138.6" W 39" H 29.25"  
L352cm W99cm H74cm



**TABLES**

## T-TABLE BISTRO

TRIBÙ STUDIO

**P. 109**

Design in its purest form, the T-Table bistro embodies refined, discreet luxury. It allows maximum leg movement when seated around its circular base, which rises seamlessly into an elegant, powder-coated stainless steel tube. The floating top comes in a choice of elegant ceramic, luxurious glazed lava stone or natural teak.



Code D2166 - round  
Ø31.5" H29.5"  
Ø80cm H75cm

Code D2160 - round  
Ø35.4" H29.5"  
Ø90cm H75cm

Code D2162 - round  
Ø49.2" H29.5"  
Ø125cm H75cm

Code D2170 - square  
L35.4" W35.4" H30"  
L90cm W90cm H76.2cm

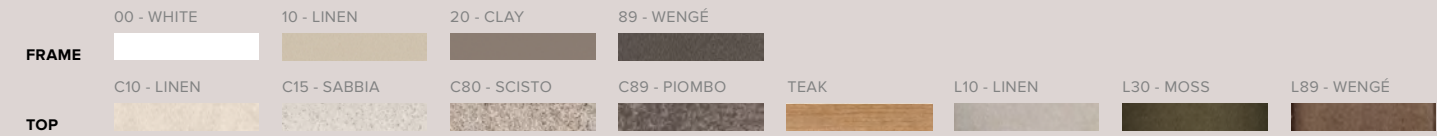

## T-TABLE OVAL

TRIBÙ STUDIO

**P. 52-53**

Two slender, powder-coated tubes suspend the floating top of the oval T-Table, keeping the design open and elegant and allowing maximum leg movement when seated. The ceramic top available in different shades is water-jetted in a distinctive oval. Smooth, warm teak, sustainably harvested from the best plantations in East Java, is together with natural lava stone an extra option for a durable table top.

Code D2175  
L94.5" W38.6" H29.5"  
L240cm W98cm H75cm

CodeD2176  
L117.3" W38.6" H29.5"  
L298cm W98cm H75cm





**TABLES**

### T-TABLE BISTRO LOW DINING

TRIBÙ STUDIO

**P. 50, 62-63**

Design in its purest form, the T-Table bistro embodies refined, discreet luxury. It allows maximum leg movement when seated around its circular base, which rises seamlessly into an elegant, powder-coated stainless steel tube. The floating top comes in a choice of elegant ceramic, luxurious glazed lava stone or natural teak.

Code D2167 - round

Ø31.5" H26,75"  
Ø80cm H68cm

Code D2161 - round

Ø35.4" H26,75"  
Ø90cm H68cm

Code D2163 - round

Ø49.2" H26,75"  
Ø125cm H68cm

Code D2172 - square

L35.4" W35.4" H26,75"  
L90cm W90cm H68cm

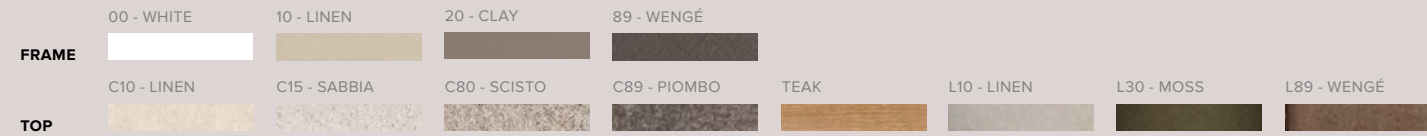

**TABLES**

### T-TABLE ELIPSE DINING

TRIBÙ STUDIO

Design in its purest form, the T-Table embodies refined, discreet luxury. It allows maximum leg movement when seated around its circular base, which rises seamlessly into an elegant, powder-coated stainless steel tube. The floating top comes in a choice of elegant ceramic, luxurious glazed lava stone or natural teak.

Code D2183

L53.5" W31.5" H29.5"  
L136cm W80cm H75cm

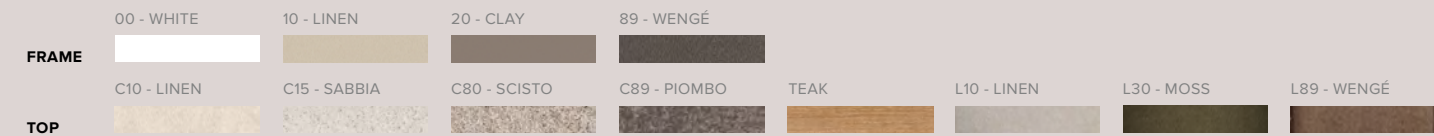

### T-TABLE OVAL LOW DINING

TRIBÙ STUDIO

Two slender, powder-coated tubes suspend the floating top of the oval T-Table, keeping the design open and elegant and allowing maximum leg movement when seated. The ceramic top available in different shades is water-jetted in a distinctive oval. Smooth, warm teak, sustainably harvested from the best plantations in East Java, is together with natural lava stone an extra option for a durable table top.

Code D2177

L94.5" W38.6" H26,75"  
L240cm W98cm H68cm

CodeD2178

L117.3" W38.6" H26,75"  
L298cm W98cm 68cm



### T-TABLE ELIPSE LOW DINING

TRIBÙ STUDIO

**P. 46**

Design in its purest form, the T-Table bistro embodies refined, discreet luxury. It allows maximum leg movement when seated around its circular base, which rises seamlessly into an elegant, powder-coated stainless steel tube. The floating top comes in a choice of elegant ceramic, luxurious glazed lava stone or natural teak.

Code D2184

L53.5" W31.5" H26.75"  
L136cm W80cm H68cm

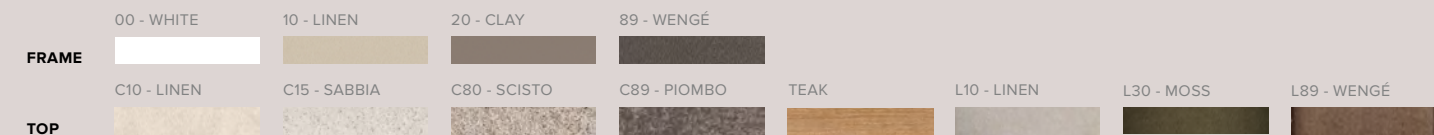





## BRANCH

LIEVORE ALTHERR MOLINA

P. 140-141

Inspired by the branches of a tree, the Branch collection has a sleek, organic look. Behind the refined look lies a sophisticated design and a well-considered choice for durable, easy-to-maintain, recyclable materials.

Code 07652

L82.6" W38.6" H29.5"  
L210cm W98cm H75cm

Code 07654

L118,1" W43,3" H29,5"  
L300cm W110cm H75cm



## TAO ROUND

MONICA ARMANI

P. 94-95, 101

The elegant Tao table collection is a lesson in perfectly balanced contrasts – bold sculptural pedestals and slim tabletops that are pleasing to the touch. Designer Monica Armani uses refined lightened concrete that evokes a look of elegant solidity. The dining table has a central pedestal, which supports a finely milled round tabletop. Tao tables come in natural linen and warm wengé tones to create striking centerpieces for any setting.

Code 01666

Ø63" H29.25"

Ø160cm H74cm

Code 01668

Ø70.9" H29.25"

Ø180cm H74cm



## BRANCH BISTRO TABLE

LIEVORE ALTHERR MOLINA

P. 137, 138-139

Inspired by the branches of a tree, the Branch collection has a sleek, organic look. Behind the refined look lies a sophisticated design and a well-considered choice for durable, easy-to-maintain, recyclable materials.

Code 07660

Ø31.5" H29.5"  
Ø80cm H75cm

Code 07662

Ø49.2" H29.5"  
Ø 125cm H75cm

Code 07671

L31.5" W31.5" H29.5"  
L80cm W80cm H75cm

Code 07670

L35.4" W35.4" H29.5"  
L90cm W90cm H75cm

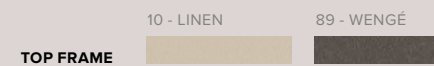
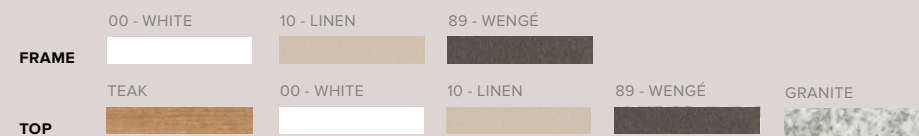

## TAO OVAL

MONICA ARMANI

P. 112-113, 168-169

The elegant Tao table collection is a lesson in perfectly balanced contrasts – bold sculptural pedestals and slim tabletops that are pleasing to the touch. Designer Monica Armani uses refined lightened concrete that evokes a look of elegant solidity. The central pedestal of the newest addition to the Tao collection, supports a finely milled grand oval tabletop, invitingly extending outdoor experiences. Tao tables come in natural linen and warm wengé tones to create striking centerpieces for any setting.

Code 01670

L94.5" W47.25" H29.25"

L240cm W120 H74cm



# LOW TABLES

## LOW TABLES



### UKIYO LOW TABLE

MONICA ARMANI

Curved lines like brushstrokes, precise and ethereal at the same time, also incorporated into the Japanese writing system, were the inspiration for the new Ukiyo collection. The Ukiyo low table is the perfect companion to add to any outdoor setting. Different options for the table top in teak or ceramic make this item adjustable for each colour palette.

Code 07588

L63" W27.5" H14.25"  
L160cm W70cm H36cm



### UKIYO COFFEE TABLE

MONICA ARMANI

P. 40-41, 42-43

Curved lines like brushstrokes, precise and ethereal at the same time, also incorporated into the Japanese writing system, were the inspiration for the new Ukiyo collection. The Ukiyo low table is the perfect companion to add to any outdoor setting. Different options for the table top in teak or ceramic make this item adjustable for each colour palette.

Code 07586

L40.25" W40.25" H14.25"  
L102cm W102cm H36cm

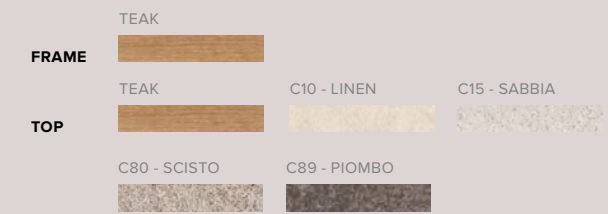

### TAO

MONICA ARMANI

P. 33

The elegant Tao table collection is a lesson in perfectly balanced contrasts – bold sculptural pedestals and slim tabletops that are pleasantly to touch. Designer Monica Armani has used refined lightened concrete to give a look of elegant solidity. The coffee table plays with symmetry by setting the finely milled square tabletop off-centre.

Code 01682

L31.5" W31.5" H14.5"  
L80cm W80cm H37cm



### OTTO

MARC MERCKX

P. 12, 16, 41, 42, 45, 47, 81, 85, 114, 117, 151, ...

Otto was inspired by a rhythmic 'ribbon' pattern, often found in Italian bar counters from the '40s. The collection also refers to ancient architectural pillars with their typical fluted pattern. Using merely one simple element, an endless yet interesting surface can be created. Wich not only significantly reducing the waste of precious teak, but creates a durable timeless design that accommodates many outdoor purposes.

Code 04284 - ø 90cm

L35.5" W35.5" H12.5"  
L90cm W90cm H32cm

Code 04280 - ø 48cm

L19" W19" H17.75"  
L48cm W48cm H45cm

Code 04281 - ø 48cm

L19" W19" H12.5"  
L48cm W48cm H32cm

Code 04282 - ø 60cm

L19" W19" H23.5"  
L60cm W60cm H45cm

Code 04283 - ø 60cm

L19" W19" H12.5"  
L60cm W60cm H32cm

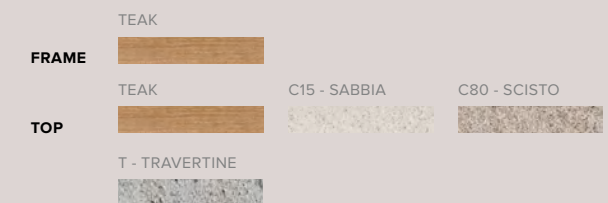



LOW TABLES

## DROPS

VERÓNICA MARTÍNEZ  
P. 57

The Drops side tables are inspired by the concentric circles formed by falling raindrops. The 3 different heights allow you to create a visual game that is even more enhanced by the connection you can make between the moon-shaped bases of the tables. The aluminium frame is powder-coated with ultra- durable structure lacquer.

Code D5026  
Ø15.75" H11.8"/15.7"/19.7"  
Ø40cm H30/40/50cm

Code D5027  
Ø23.5" H11.8"/15.7"/19.7"  
Ø60cm H30/40/50cm

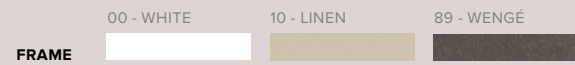

## NATAL ALU X

TRIBÙ STUDIO  
P. 8, 30-31, 33, 43, 47, 67, 81, 124, 155, 173

The Natal Alu X low tables in aluminium combine functionality and aesthetics in a contemporary but timeless design. With different possibilities in shape, colours, heights and dimensions, you will always find the perfect coffee table for your setting to create elegant combinations.

Code 01676      Code 01682  
Ø 13.75" H17.75"      L 23.5" W 23.6" H13.75"  
Ø 35cm H45cm      L 60cm W 60cm H35cm

Code 01680  
L 15.75" W 15.75" H13.75"  
L 40cm W 40cm H35cm

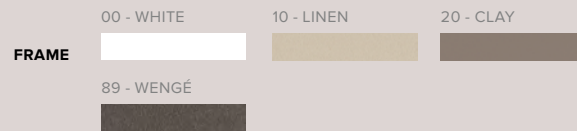

LOW TABLES

## T-TABLE

TRIBÙ STUDIO  
P.55, 89

A timeless addition to any outdoor setting, the T-Table coffee table is a perfectly balanced piece of design. The floating table top rises from a powder-coated stainless steel stem with circular base and showcases a top made of smooth, warm teak, sustainably harvested from the best plantations in East Java.

Code D2174      Code D2164      Code D2165      Code D2168  
L35.4" W35.4" H13.75"      Ø35.4" H13.75"      Ø49.2" H13.75"      Ø31.5" H13.75"  
L90cm W90cm H35cm      Ø90cm H35cm      Ø125cm H35cm      Ø80cm H35cm

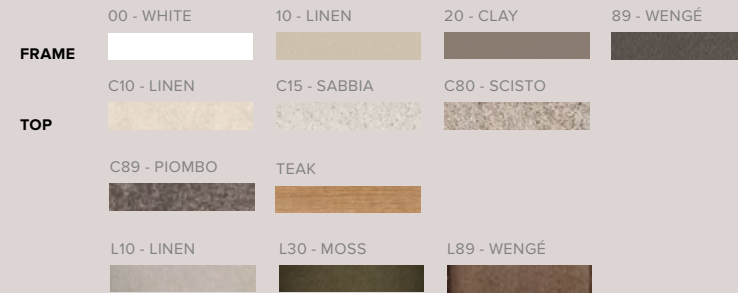

## T-TABLE OVAL

TRIBÙ STUDIO  
P. 104-105

A timeless addition to any outdoor setting, the T-Table coffee table is a perfectly balanced piece of design. The floating table top rises from a powder-coated stainless steel stem with circular base and showcases a top made of smooth, warm teak, sustainably harvested from the best plantations in East Java.

Code D2180      Code D2179  
L 117.3" W 38.6" H13.75"      L 94.5" W 38.6" H13.75"  
L 298cm W98cm H35cm      L 240cm W98cm H35cm



## TOSCA

MONICA ARMANI



The elegant, tapered legs and the unique round shape of the tabletop give the Tosca coffee table a very high-end look. The scratch- and stain-resistant ceramic top with delicate clouded pattern is coloured in the mass and laminated on glass.

Code 05381      Code 05386  
L21.25" W19" H19.5"      L38.5" W33.75" H12.5"  
L54cm W48cm H49,5cm      L98cm W86cm H31,5cm



## SENJA

STUDIO SEGERS

P. 67



The free-standing Senja coffee table coordinates perfectly with your Senja sofa set. Lava stone table tops in ocean or linen, or a teak option, are subtle additions to the Senja sofa setting. The frame also comes in a choice of two colours with three options for the legs.

Code 023204      Code 023205  
table top teak      table top lava stone  
L33,75" W33,75" H11"      L33,75" W33,75" H11"  
L86cm W86cm H28cm      L86cm W86cm H28cm

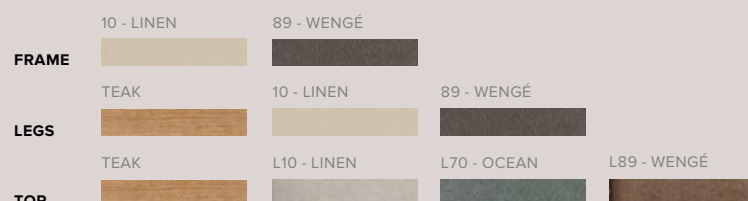

## T-TABLE ELIPSE

TRIBÙ STUDIO

P.114-115



A timeless addition to any outdoor setting, the T-Table coffee table is a perfectly balanced piece of design. The floating table top rises from a powder-coated stainless steel stem with circular base and showcases a top made of smooth, warm teak, sustainably harvested from the best plantations in East Java.

Code D2185  
L53.5" W31.5" H13.75"  
L136cm W80cm H35cm





LOW TABLES

## VIS À VIS

PIERGIORGIO CAZZANIGA

P. 28-29, 32-33, 35, 46-47, 54-55, 85, 131, ...



The Vis à Vis coffee table is characterised by solid square slats with slightly rounded corners. The teak is of the best quality you can find. Only A-grade wood, grown in sustainably managed plantations in East Java is used. Every log is handpicked during the cutting process of the tree. The coffee tables have the same square slats as the sofa borders and can stand alone or be attached to the sofa.

Code 01781	Code 01784
L39" W39" H71"	L47.6" W39" H71"
L99cm W99cm H18cm	L121cm W99cm H18cm

Code 01786  
L47.6" W47.6" H71"  
L121cm W121cm H18cm

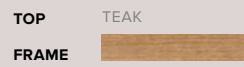
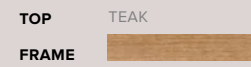

## VIS À VIS LOW TABLE

PIERGIORGIO CAZZANIGA

P. 16-17, 182



The Vis à Vis low table is characterised by solid square slats with highly rounded corners. The teak is of the best quality you can find. Only A-grade wood, grown in sustainably managed plantations in East-Java is used. Every log is handpicked during the cutting process of the tree. The low table has the same square slats as the sofa borders. Like the coffee tables, this newest addition to the Vis à Vis family grabs attention as an elegantly slim stand-alone center piece or used as a subtle side table. Its versatility is endless.

Code 07132  
W62.5" D17.25" H7"  
W159cm D44cm H18cm

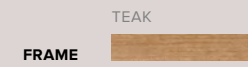

LOW TABLES

## ROOTS

TRIBÙ STUDIO

P. 8, 17, 30, 50, 122-123, 124, 188-189



This outdoor accessory with a primal look is made of one massive piece of teak and therefore very exclusive. Chiseled out of Tribù's plantation-grown teak, every detail, every knot, every crack is proudly on display.

Code D8102  
L11.75" W11.75" H15.75"  
L30cm W30cm H40cm

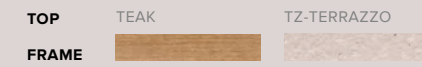

## DUNES

YABU PUSHELBERG

P. 9, 13, 31, 41, 43, 47, 49, 54, 59, 63, 66, 108, ...

The Dunes low dining, coffee and side table, simply shaped as an unpretentious piece of sculpture, are now available in teak wood and an innovative terrazzo by Tribù. The skillfully carved solid teak wood originates from East-Java. Its rounded, central base, whose natural cracks are part of its charm, supports a smooth circular tabletop. Tribù's innovative terrazzo-inspired table is made from natural stones set in lightened concrete, with a blend of fibres which enhance durability.

Code D8300	Code D8304
Ø19" H19.75"	Ø36.25" H24"
Ø48cm H50cm	Ø92cm H61cm

Code D8302  
Ø23.5" H15.75"  
Ø60cm H40cm

## HEXAGON

MARC MERCKX

P. 193, 171



The rugged basalt columns of the Giant's Causeway in Northern Ireland were the inspiration for the Hexagon side table. It comes in a variety of heights and sizes, like the basalt columns, which makes a strong statement when grouped together. The sturdiness and pure symmetry of honeycomb also influenced these teak side tables. Hand crafted glazed lava stone, each piece unique and available in a selection of 4 colours, adds to the bold, natural look.

Code D5040	Code D5041
L27.25" W23.62" H12.25"	L19.75" W16.93" H19.25"
L69cm W60cm H31cm	L50 W43cm H49cm

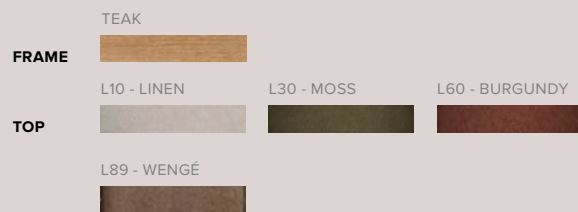
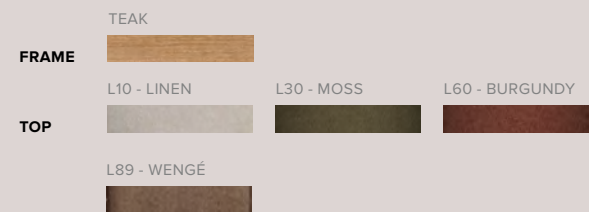

## TAIRU

TRIBU STUDIO

P. 28, 31, 35, 67, 72, 89, 90, 92, 115, 125, 184



The Tairu side table mixes practicality with natural beauty. The base is formed from a sturdy, hollow wooden rectangle with inset handles so it can be moved around easily. What sets the Tairu apart is the top, made from glazed lava stone from the Vesuvius. It is available in four sophisticated shades, each with a very subtle craquelure finish. The colours are applied by hand, which makes every piece unique.

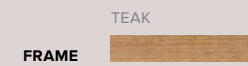

## C-TABLE

TRIBÙ STUDIO



The C-table is a smart passe-partout side table, made in teak harvested from the finest plantations in East-Java. Its simple, angular form matches well with the Pure Sofa and fits just over the cushions.

Code 01285  
L 15.75" W 13.75" H 19"  
L 40cm W 35cm H 48cm  
Inside H 15.7" / 40cm



## MOOD

STUDIO SEGERS

Thanks to its beautifully finished round edges and its slightly tapered legs, the Mood coffee table has a friendly and soft look. The teak Tribù selects for its outdoor furniture is of the best quality you can find. Only A-grade wood is used, grown in sustainably managed plantations in Indonesia and controlled all year long by subsidiary Tribù Asia.

Code 06282  
L26" W26" H11"  
L66cm W66cm H28cm

Code 06284  
L47,24" W26" H11"  
L120cm W66cm H28cm

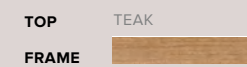



# SUNBEDS



## SUNBEDS

### UKIYO LOUNGER

MONICA ARMANI

P. 44-45

Ukiyo is a warm and welcoming collection that remains etched into your memory, interpreting the exclusive and refined style of Tribù. So does the Ukiyo lounger, which welcomes you to relax on a comfortable cushion while the versatile and timeless design continues to surprise you.

Code 07540

W30" L79.25" H11.5" SH14.5"

W76cm L201cm H29cm SH37cm

TEAK

FRAME

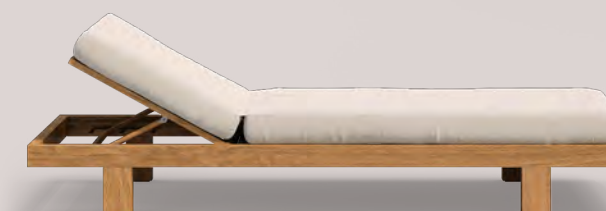

### PURE LOUNGER

ANDREI MUNTEANU

P. 156-157, 158-159

Pure delicately channels design to its very essence: pure simplicity and elegance. The highly modular sofa system can now be combined with the latest sophisticated addition joining the Pure family: the Pure lounger. This inviting sunbed comes in 3 versions: with and without fixed wood legs and an extra leg version discretely equipped with integrated wheels, conveniently allowing easy mobility. The comfortable bold cushion provides a generous luxury lounging experience.

Code 01242 without legs and wheels

W35.5" L82.25" H7" SH13"

W90cm L209cm H17.5cm SH32.5cm

Code 01243 with legs

W35.5" L82.25" H9.75" SH15.75"

W90cm L209cm H25cm SH40cm

TEAK

FRAME





SUNBEDS

## NODI LOUNGER

YABU PUSHELBERG

P. 50, 56-57

The Nodi lounger combines minimalism with a casual touch. Light and airy, its silhouette is defined by twisted, interlaced rope in weather-resistant Canax®, stretched across a slender, sculptural frame in powder-coated inox. The open weave in Canax®, a combination of PVC and natural hemp, crosses in vertical and horizontal lines, providing shape and structure to the seat and back.

Code 01940

W29.5" L76.75" H13" SH15"

W75cm L195cm H33cm SH38

	00 - WHITE	89 - WENGÉ
<b>FRAME</b>		
	00/10 - OFF WHITE + LINEN	10 - LINEN
<b>WEAVE</b>		

## FORUM LOUNGER

TRIBÙ STUDIO

The Forum lounger is light, yet made of a very steady aluminium construction, and provides an excellent seating comfort. The frame in aluminium is powder-coated with ultra-durable structure lacquer for a nice matte look. The seat is made of Batyline which is reputed for its durability, UV resistance and lasting high tension.

Code 06040

W26.75" L76.75" H12,5" SH14.5"

W68cm L195cm H32cm SH37cm

	00 - WHITE	10 - LINEN	89 - WENGÉ
<b>FRAME</b>			

SUNBEDS

## ILLUM LOUNGER

MERCKX & MAES



P. 162, 164-165

The Illum lounger not only inclines, but also lowers itself to offer an unmatched comfort, while all the mechanics involved – a newly developed pump system - are astutely hidden away. The frame is made of aluminium, powder-coated with a double layer of ultra-durable structure lacquer for a nice matte look. The seating in Batyline guarantees durable high tension and excellent resistance to UV rays, dirt and mould.

Code 06540

W27.5" L78.75" H15.25" SH16.5"

W70cm L200cm H39cm SH42cm

	00 - WHITE	10 - LINEN	89 - WENGÉ
<b>FRAME</b>			

## NATAL ALU LOUNGER

STUDIO SEGERS

The adjustable Natal Alu lounger is generously sized with a Batyline seat and sturdy wheels. The aluminium frame is powder-coated with ultra-durable, UV- and scratch resistant structure lacquer for a nice matte look. Batyline® from Ferrari is renowned for its exceptional tear strength and dimensional stability, ensuring it will keep its shape and colour.

Code 05940

W28.3" L80.7" H13" SH14.25"

W72cm L205cm H33cm SH36cm

	89 - WENGÉ
<b>FRAME</b>	



SUNBEDS

## TOSCA LOUNGER

MONICA ARMANI

P. 93

A low frame in powder-coated stainless steel is upholstered with an extra -large, vertical weave, developed exclusively by Tribù. A combination of Textilene® and Tricord® (polyolefin) is knitted over a tube of EPDM foam without any visible joint. The material which has a natural look and feel, is nevertheless fungi resistant, stain repellent and does not fade

Code 05430

W28.3" L80.7" H13" SH13"

W72cm L205cm H33cm SH33

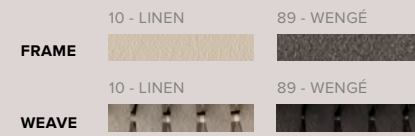

SUNBEDS

## VIS À VIS LOUNGER

PIERGIORGIO CAZZANIGA

P. 87

Deep cushions in bold shapes with a discreet teak base frame make our Vis à Vis sunbed a refined addition to your terrace. The lounger uses an essential design element from our Vis à Vis sofa – back cushion is supported – so that it looks good from every angle.

Code 01741 with weels

W42.25" L80.75" H11.75" SH13.75"

W107cm L205cm H30cm SH35cm

Code 01740 without weels

W42.25" L80.75" H11.75" SH13.75"

W107cm L205cm H30cm SH35cm

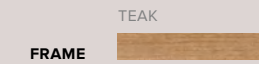

## BRANCH LOUNGER

LIEVORE ALTHERR MOLINA

P. 142-143

Elegantly tapered legs and a crisp, clean silhouette define the Branch lounger. The slender frame is made of high pressure injected aluminium, a specialised technique that makes the lounger incredibly strong yet surprisingly light. Powdercoating the frame with a double ultra-durable lacquer adds a high performance finish. The Branch lounger can be stacked up to 12 pieces high, making it ideal for the hospitality sector.

Code 07640

W28.75" L81.5" H13.5" SH14.5"

W73cm L207cm H34cm SH37cm

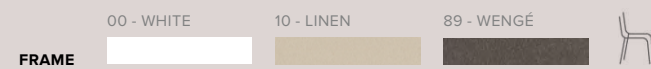

## KOS LOUNGER

STUDIO SEGERS

P. 148-149

The combination of the broad slats and the pure, but powerful design of the Kos lounger reinvents teak in a modern, robust way. Tribù uses only the very best teak from East Java. Every log is handpicked during the cutting process of the tree. The lounger is adjustable into five positions and has wheels with non-marking rubber.

Code 04040

W 25.5" L 77.25" H 10.25" SH14.25"

W 65cm L 196cm H 26cm SH36cm

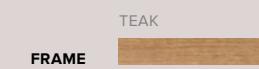



SUNBEDS

## SENJA LOUNGER

STUDIO SEGERS

P. 64-65

Ultimate comfort is the essence of the Senja lounger. The voluminous cushions ease away any stress and an optional full-length teak side table means you never have to move, with everything you need close to hand. The extra-soft, weather-proof cushion filling supported by tear-resistant Batyline, combined with a powder-coated aluminium frame, make the Senja lounger as durable as it is indulgent.

Code 02340	Code 02341 with teak sidetable
W29,5" L80,75" H9,4" SH15,25"	W41" L80,7" H9,4" SH15,25"
W75cm L205cm H24cm SH39	W104cm L205cm H24cm SH39

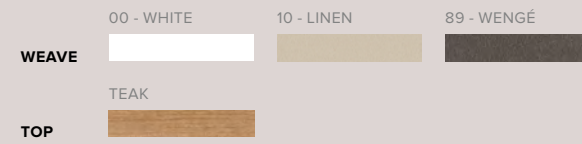

## CTR MERIDIENNE

PIERGIORGIO CAZZANIGA

P. 128-129

CTR is characterised by a tube in powder-coated stainless steel that follows the outline of the meridienne in one continuous line. The woven backrest, attached at only 2 points to the frame, ensures an outstanding back support while the slightly inclined base ensures relaxed seating. The yarn in polyolefin used for the weave, resists all weather conditions, but has nevertheless a surprisingly natural look and feel.

Code 01103	Code 01104
meridienne left	meridienne right
W38.6" L72.4" H31.9"	W38.6" L72.4" H31.9"
W98cm L184cm H81cm	W98cm L184cm H81cm



SUNBEDS

## SENJA MERIDIENNE

STUDIO SEGERS

Curl up and relax on the Senja meridienne for comfortable and luxurious lounging, personalised to your own unique taste thanks to various choices of frame and leg colours and over 100 nature-inspired outdoor fabrics. You can even attach an elegant side table to the frame, keeping everything you need at hand.

Code 023301	Code 023302	Code 023401
meridienne left arm HIGH	meridienne left arm LOW	meridienne right arm HIGH
W73.25" L45.75" H30.25"	W73.25" L45.75" H30.25"	W73.25" L45.75" H30.25"
W186cm L116cm H77cm	W186cm L116cm H77cm	W186cm L116cm H77cm

Code 023402
meridienne right arm LOW
W73.25" L45.75" H30.25"
W186cm L116cm H77cm

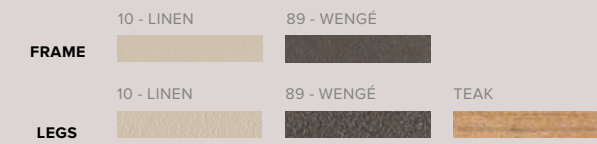

## NATAL ALU MERIDIENNE

STUDIO SEGERS

P. 122-123

A subtle frame with curved armrests contrasts beautifully with the volume of the cushions, supported by a weave of wide textile straps. Timeless and elegant, the Natal Alu Sofa meridienne looks great on any patio. The aluminium frame is powder coated with ultra-durable, UV- and scratch resistant textured lacquer which provides a beautiful matte look.

Code 05868	Code 05869
meridienne right	meridienne left
W39" D74" H23.5"	W39" D74" H23.5"
W99cm D188cm H60cm	W99cm D188cm H60cm

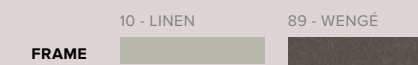



SUNBEDS

TOSCA DAYBED

MONICA ARMANI

P. 96-97



An elegant seating shell in powder-coated stainless steel is upholstered with an extra- large, vertical weave, developed exclusively by Tribù. A great deal of research resulted in a unique product with a natural and soft appearance, that is nevertheless 100% weatherproof. A combination of Textilene® and Tricord® (polyolefin) is knitted over a tube of EPDM foam without any visible joint. The material is moult resistant, stain repellent and does not fade.

Code 05349

W67" L73,25" H32,25 SH15,8"  
W170cm L186cm H82 SH40cm

	10 - LINEN	89 - WENGÉ
<b>FRAME</b>		
	10 - LINEN	89 - WENGÉ
<b>WEAVE</b>		

SUNBEDS

MOOD LOUNGE BED / DAYBED

STUDIO SEGERS

P. 108, 110-111



A cosy design in warm, natural materials. The innovative Tricord® yarn has been designed exclusively for Tribù. The polyester core provides strength and stability, while the combination of nautical fibres (polyolefin) creates a surprisingly soft look and touch, ensuring nevertheless resistance to all outside influences : frost, water, fungi and UV-rays. The backs can be replaced separately.

Code 06250

W60,25" L60" H27,25" SH17"  
W153cm L142cm H68cm SH43cm

Code 06249

W63,75" L68,5" H27,25" SH17"  
W162cm L174cm H 68cm SH43cm

	TEAK		
<b>FRAME</b>			
	10 - LINEN	85 - EARTHBROWN	89 - WENGÉ
<b>WEAVE</b>			

PAVILION DAYBED

MONICA ARMANI

P. 171



Capture sunshine and shade with the Pavilion daybed, designed by Monica Armani. The classic canopied bed has been updated with a slimline powder-coated aluminium frame. The daybed can be personalised with a choice of sheer curtain fabrics and paint finishes, while the back and ceiling come in different materials. The super-strong Batyline seat lining can be used alone or with 2 comfortable outdoor cushions and can be further customised with a detachable side table.

Code 018XX

W82,75" D86,26" H88,25" SH15,7"  
W210cm D219cm H224cm SH40cm

Options back wall: teak slats, aluminium slats, sunvision or no back wall

Options roof: teak slats, aluminium slats, movable sunvision

Accessories: curtains

	00 - WHITE	89 - WENGÉ	TEAK
<b>FRAME</b>			

PURE CABANA

ANDREI MUNTEANU

P. 151



Pure delicately channels design to its very essence: pure simplicity and elegance. After decades of luxury outdoor experiences, with Pure cabana the most sophisticated addition is now joining the Pure family. Together with slidable side curtains, the back and ceiling in Sunscape fabric, facilitate sunshine and shade to be captured according to personal moods. The gorgeous daybed can easily be accessorized with various side tables, keeping food, drinks and precious items within reach.

Code 01249

W74,5" D86,25" H80,75" SH15,75"  
W189cm D219cm H205cm SH40cm

	TEAK		
<b>FRAME</b>			
	V54-OYSTER	V64-NATURE GREY	V70-STONE
<b>CURTAIN</b>			



# ACCESSORIES

## ACCESSORIES



### NOMAD

MONICA ARMANI

P. 14, 63, 91, 105, 123, 129, 185

Conceived for the outdoors, the Nomad poufs are totally waterproof thanks to a draining structure consisting of EPS, upholstered with dryfoam. They are slightly raised from the ground by three little feet attached to a base in marine grade plywood. The Nomad poufs are available in a range of no less than 140 different outdoor fabrics.

Code C05032W

Ø24" H18"  
Ø61cm H46cm

Code C05033W

Ø36.25" H17"  
Ø92cm H43cm

Code C05034W

Ø48" H13"  
Ø122cm H33cm



### POUFS

TRIBÙ STUDIO

P. 90

The fluffy design of these irresistible poufs, available in 3 sizes, transforms your terrace in an extra cosy place in just a minute. With more than 100 nature-inspired fabrics to choose from and a weather-resistance you can count on, these poufs are the ideal accessories to add some colour to your lounge area.

Code C0009W

Ø17.75" H15.75"  
Ø45cm H40cm

Code C0010W

Ø23.5" H16.5"  
Ø60cm H42cm

Code C0011W

Ø35.5" H15"  
Ø90cm H38cm



### MAI

ILIA ECKARDT

P. 8-9, 12-13, 118-119, 151, 154-155, 183, 184

The organic structure of the fully knitted Mai collection originates from the design philosophy of creating intense connection between people and nature, incorporating elements of nature into design. Designer Ilia Eckardt's contemporary approach to traditional knitting techniques results in this sophisticated leaf inspired texture that subtly plays with directions, showcasing experimentation in the design.

Code 05582-12 SQUARE

W39.25" D39.25" H14.5"  
W100cm D100cm H36.7cm

Code 05584-12 RECTANGULAR

W39.25" D19.75" H14.5"  
W100cm D50cm H36.7cm



### GOBI

ILIA ECKARDT

P. 12, 44, 91, 92, 98, 111, 146, 151, 159, 180-181

The idea of GOBI was inspired by Ilia Eckardt's innovative handmade crochet technique and is an enlarged version of a heritage knit stitch. It's an impressive handmade piece consisting of recycled yarn, with strong visual impact and a reflection of true skill. The contemporary take on celebrated craftsmanship and the presence of a mood-enhancing organic feel flawlessly embody nature.

Code D3010

W23.5" D23.5" H19.75"  
W60cm D60cm H50cm

Code D3020

W15.75" D15.75" H11.75"  
W40cm D40cm H30cm

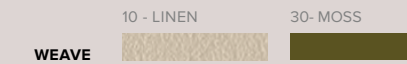
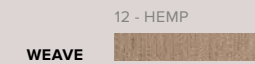



ACCESSORIES

LOFT

TRIBÙ STUDIO



By combining your choice of Tribù furniture and accessories, you can create the perfect outdoor entertaining space. Adding a rug brings these design elements together and adds a focal point to the scene. The Loft outdoor rugs are available in white, wengé and linen and are made of a coloured weave of PVC-coated polyester.

Code D2001 without fringes

- W78.7" D78.7" / 200x200cm
- W78.7" D94.5" / 200x240cm
- W78.7" D118.1" / 200x300cm
- W98.4" D98.4" / 250x250cm
- W98.4" D118.1" / 250x300cm
- W98.4" D137.8" / 250x350cm



SHINDI

TRIBÙ STUDIO

P. 8, 10, 12, 15, 16, 18, 21, 26, 30, 33, 38, 40, ...

A 3D weave gives the Shindi outdoor rugs a luxurious look. Made of 100% solution-dyed PVC-coated polyester, the rugs are extremely resistant to sun, rain and mildew. Thanks to the natural colours of linen, hemp and wengé, the rugs create a warm and homely cosiness and provide the perfect finishing touch for your patio.

Code D2003

- W78.7" D78.7" / 200x200cm
- W78.7" D98.4" / 200x250cm
- W78.7" D118.1" / 200x300cm
- W78.7" D137.8" / 200x350cm
- W78.7" D177" / 200x450cm
- W118.1" D118.1" / 300x300cm
- W118.1" D 57.5" / 300x400cm

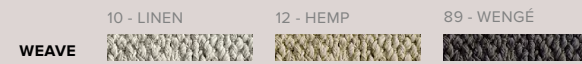
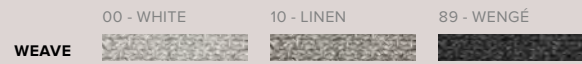

MONSIEUR TRICOT

ILIA ECKARDT

P. 107, 112-113, 127, 176-177



Monsieur Tricot is a collection of knitted and hand crocheted outdoor lighting elements that will turn your outdoor space and garden into a magical place. The lamps combine traditional techniques with high-performing materials and modern technology. Designer Ilia Eckhardt composed his collection as a family. Meet the handsome Monsieur Lebonnet, the graceful Madame Latoque, the chic Madame Cachet and their nephew Monsieur Ellipse.



MONSIEUR TRICOT

ILIA ECKARDT

P. 67, 131, 132, 139, 155, 173, 174, 183, 185, 188

Monsieur Tricot is a collection of knitted and hand crocheted outdoor lighting elements that will turn your outdoor space and garden into a magical place. Designer Ilia Eckhardt composed his collection as a family. Meet the handsome Monsieur Lebonnet, the graceful Madame Latoque and the chic Madame Cachet. Besides an on/off switch, the lamps can be operated with a Tribù app. The battery is rechargeable with an USB slot.

<b>HANGING MONSIEUR LEBONNET</b>	<b>HANGING MADAME LATOQUE</b>	<b>HANGING MADAME CACHET</b>	<b>HANGING MONSIEUR ELLIPSE</b>
Code D080130H Ø11.8" / Ø30cm	Code D080230H Ø11.8" / Ø30cm	Code D080330H Ø11.8" / Ø30cm	Code D080440H Ø15.7" / Ø40cm
Code D080140H Ø15.7" / Ø40cm	Code D080240H Ø15.7" / Ø40cm	Code D080340H Ø15.7" / Ø40cm	
Code D080160H Ø23.6" / Ø60cm		Code D080350H Ø19.7" / Ø50cm	

<b>STANDING MONSIEUR LEBONNET</b>	<b>STANDING MADAME LATOQUE</b>	<b>STANDING MADAME CACHET</b>
Code D080130S Ø11.8" / Ø30cm	Code D080230S Ø11.8" / Ø30cm	Code D080330S Ø11.8" / Ø30cm
Code D080140S Ø15.7" / Ø40cm	Code D080240S Ø15.7" / Ø40cm	Code D080340S Ø15.7" / Ø40cm
Code D080160S Ø23.6" / Ø60cm		Code D080350S Ø19.7" / Ø50cm

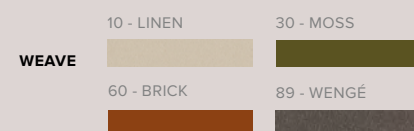
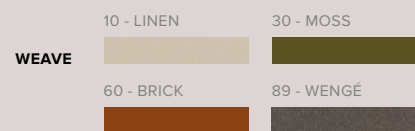

ACCESSORIES

ECLIPSE WOOD

TRIBÙ STUDIO

P. 196-197

The Eclipse umbrellas with a wooden pole not only provide welcoming cool shade, but also create a warm, inviting atmosphere on your patio. These wooden umbrellas are available in different models and feature user-friendliness and durability. The canvas is available in two different colours.



Code UW315  
Ø137.8" H102.3  
Ø350cm H260cm

Code UW322  
W118.1" D118.1" H102.3"  
W300 D300cm H260cm

Code UW323  
W137.8" D137.8" H102.3"  
W350 D350cm H260cm

Code BG32 BASE GRANITE  
W22.75" D22.75"  
W58cm H58cm

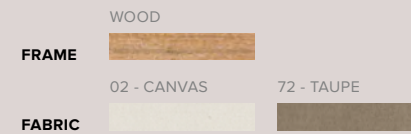
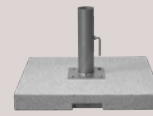

ECLIPSE ALU

TRIBÙ STUDIO

This elegant design umbrella, available in a square and round shape, has a very solid pole in powder-coated aluminium. The canvas is made of durable, solution dyed Sunbrella outdoor fabric and is attached with flathead bolt connections to the ribs. The umbrella is easy to operate thanks to a double pulley system in electropolished stainless steel 316 and can withstand all weather conditions. Base in granite and protective cover available.

Code UA315  
Ø137.8" H102.3  
Ø350cm H260cm

Code UA322  
W118.1" D118.1" H102.3"  
W300 D300cm H260cm

Code UW323  
W137.8" D137.8" H102.3"  
W350 D350cm H260cm

Code BG32 BASE GRANITE  
W22.75" D22.75"  
W58cm H58cm

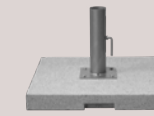

LUNA

YABU PUSHELBERG

P. 17, 42, 47, 114, 182, 184, 186, 194-195

Versatile contemporary design, uniting people with their environment, smart inaugural lighting, multi-purpose design As portable lanterns, Luna does what it's designed for, uniting people with their environment. Inspired after hosting a gathering with friends, founding partners of global design house Yabu Pushelberg, designed the inaugural lighting collection Luna, a cordless lantern that unites people with nature.



Code D09010  
W8.75" D7" H20.75"  
W22cm D18cm H53cm



LANTERN

TRIBÙ STUDIO

P. 26, 30, 71, 86, 143, 152, 182

Our teak lanterns with thermally reinforced glass make your summer evenings even more cozy. Their simple design makes them the perfect accessories for any outdoor space. Create variation by combining the two available sizes with the teak base.

Code D5015  
W13.75" D13.75" H13.8"  
W33cm D33cm H35cm

Code D5016  
W13.75" D13.75" H20.1"  
W33cm D33cm H51.5cm

Code D5017  
W13.75" D13" H14.5"  
W33cm D33cm H37cm

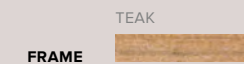



ELMINA.<sup>®</sup>  
*môj životný štýl*

ELMINA Bratislava | OC LIGHTPARK | Račianska 90 | Bratislava  
**www.elmina.sk** | elmina@elmina.sk | +421 910 919 711  
Ceny vr. DPH



# TRIBÙ

10/01/2023 - 09/30/2024

ELMINA<sup>®</sup>  
mój životný štýl



# 2 INDEX

---

	AMANU	8	<b>UPDATED</b>	ACCESSORIES	96
	BRANCH	10		LANTERNS	96
	CTR	12		LUNA	96
	ELIO	16		GOBI	96
	FORUM	18		LOFT RUGS	97
<b>UPDATED</b>	ILLUM	19		SHINDI RUGS	97
	KOS	22		MONSIEUR TRICOT HANGING	98
	MOOD	24		MONSIEUR TRICOT STANDING	99
	NATAL ALU	29		POUFS	100
<b>UPDATED</b>	NATAL ALU SOFA REGULAR	30		NOMAD POUFS	100
<b>UPDATED</b>	NATAL ALU SOFA DEEP	31	<b>NEW</b>	MAI POUFS	100
<b>UPDATED</b>	NATAL ALU SOFA MERIDIENNE	32		DECO CUSHIONS	101
<b>UPDATED</b>	NATAL ALU SOFA SETS	33		MAINTENANCE PRODUCTS	102
<b>UPDATED</b>	NATAL ALU X TABLE	36		LOW TABLES OVERVIEW	104
	NODI	37		DINING TABLES - BY SIZE	106
	NODI SOFA REGULAR	38		DINING TABLES - BY MATERIALS	108
	NODI SOFA DEEP	39		COVERS FOR SOFA'S	109
	NODI SOFA LOUNGE	40		COVERS FOR DINING TABLES	110
	NODI SOFA MERIDIENNE	41		COVERS FOR LOW TABLES	111
	NODI SOFA SETS	42			
	NOMAD	46			
	NOX	47			
<b>NEW</b>	OTTO	48			
	PAVILION DAYBED	50			
<b>UPDATED</b>	PURE SOFA	53			
	PURE SOFA SETS	56			
	SENJA	58			
	SENJA SOFA REGULAR	60			
	SENJA SOFA DEEP	62			
	SENJA SOFA MERIDIENNE	64			
	SENJA SOFA SETS	66			
<b>NEW</b>	SURO	70			
<b>UPDATED</b>	T-TABLE DINING	72			
<b>UPDATED</b>	T-TABLE LOW DINING	73			
<b>UPDATED</b>	T-TABLE COFFEE	74			
<b>UPDATED</b>	TAO TABLE	75			
	TOSCA	76			
	UKIYO	81			
	VIS À VIS	83			
	VIS À VIS SOFA	86			
	VIS À VIS SOFA SETS	88			
	UMBRELLAS	91			
	LOW TABLES	93			
	DROPS	93			
<b>UPDATED</b>	DUNES SIDE TABLE	94			
<b>UPDATED</b>	DUNES COFFEE TABLE	94			
	DUNES LOW DINING TABLE	94			
	ROOTS	94			
	TAIRU	95			
	HEXAGON	95			
<b>UPDATED</b>	OTTO	95			



---

TECHNICAL STANDARDS - NORMAS TÉCNICAS 114

CUSHIONS - COJINES

PRICING CUSHIONS	120
FIRE RETARDANT CUSHIONS	121
COLORS	122
FILLINGS	135
FABRIC TYPES	138
SOLUTION DYED ACRYLICS	139
SOLUTION DYED POLYOLEFIN	140
PVC COATED POLYESTER	141
FABRIC PROPERTIES	142
LEGEND FABRIC PROPERTIES	149

MATERIALS - MATERIALES

ALUMINIUM	152
POWDERCOATED STAINLESS STEEL	153
TEAK	154
SYNTHETICS	157
BATYLINE®	158
CANAX®	159
CANAX® STRAPS	160
TRICORD®	161
TOSCA WEAVE	162
TEXTILENE STRAPS	163
CERAMIC	164
LIGHTENED CONCRETE	165
GRANITE	168
GLAZED LAVA STONE	169
NEW TRAVERTINE	170
NEW TERRAZZO	171
RECYCLED ACRYLIC	172
NEW VILEX WEAVE	173
NEW BRASS METAL	174
NEW TRIZO WEAVE	175
OUTDOOR RUGS	176
MONSIEUR TRICOT	177

MAINTENANCE - MANTENIMIENTO

CLEANING	182
PROTECTING	183
PRODUCTS	184

PACKING LIST - LISTA DE EMBALAJES 194







# 6 LEGEND

## LEYENDA

 Stackable  
Apilable

 To assemble  
Requiere montaje



Right arm  
Brazo derecho



Left arm  
Brazo izquierdo

 Lounger with wheels  
Tumbona con ruedas

### General Information

Dimensions and technical details may be subject to changes without prior notice. Tribù cannot be held responsible for any possible printing errors.  
Medidas y acabados técnicos pueden sufrir cambios sin aviso previo. Tribù no puede ser considerado responsable por posibles errores de impresión.

The reproduction of colors may differ from reality.  
La representación de los colores puede variar de la realidad.

In the case of the shade of wengé, the designation refers exclusively to the shade and not to the material.  
En el caso de la tonalidad Wenge, la denominación se refiere únicamente a la tonalidad y no al material.

When ordering a sofa configuration that is not shown in the price list, please include a sketch with your order.  
Cuando solicite una configuración de sofá que no se muestra en la lista de precios, por favor incluya un boceto con su pedido.



# WARRANTY

## GARANTÍA

### Terms of warranty

A warranty period of 3 years applies to all Tribù branded furniture items and 1 year for cushions, fabrics and protective covers, against all manufacturing and material errors that would affect their use. The warranty commences on the day the product was bought from an official Tribù trading partner (see date on the proof of purchase).

The warranty applies to manufacturing and material errors that occur during normal usage, and not to errors or deficiencies occurring in the course of time or normal usage (wear and tear). Conditions not covered by this warranty include – but are not restricted to – colors fading, changes in wood textures, scratches occurring during use, damage resulting from defective maintenance or incorrect use, etc. The warranty does not for example cover discoloration or colors running, cracks, scratches or tears occurring in the varnish due to usage.

### Condiciones de garantía

Para todos los productos de la marca Tribù se aplicará un período de garantía de 3 años (1 año por cojines, telas y fundas protectoras) contra defectos de fábrica o material. La garantía empezará el día el día indicado en la fecha de la factura, en que dicho producto fue adquirido a través de un dealer oficial de Tribù.

La garantía se aplicará a errores de material y producción surgidos durante el uso normal, no a errores o imperfecciones que se deben al paso del tiempo o el uso normal (desgaste). Las circunstancias no cubiertas por la presente garantía incluyen – pero no se limitan a – los desvanecimientos de color, cambios en las texturas de madera, rasguños causados por el uso, daños ocasionados por un mantenimiento defectuoso o un uso erróneo, etc. La garantía no cubrirá, por ejemplo, colores desteñidos o corridos, grietas, rasguños o fisuras de la laca originados por el uso del producto.





Plantation teak from Java  
Teca de plantación de Java

Canax®  
Canax®

Armchair  
Silla con brazos

02618-10



**D2618**  
Cover  
Funda

**C02618SW**  
Seat cushion  
Cojín de asiento

**C02618W**  
Seat & Back Cushion  
Cojín de asiento y respaldo



Lounge chair  
Sillón

02612-10



**D2612**  
Cover  
Funda

**C02612W**  
Seat & Back Cushion  
Cojín de asiento y respaldo





Plantation teak from Java  
 Teca de plantación de Java

Table top: ceramic  
 Tablero de mesa: cerámica

\*This color may possibly show delicate veins.  
 \*Este color puede mostrar pequeñas vetas

 Dining table 114.25"  
 Mesa de comedor 290cm

02652-C15

02652-C80

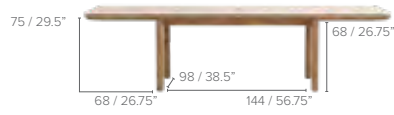

 Dining table 137.75"  
 Mesa de comedor 350cm

02654-C15

02654-C80





Aluminum, high pressure injected  
Aluminio inyectado a alta presión

Polypropylene reinforced with glassfiber  
Polipropileno reforzado con fibra de vidrio

Batyline  
Batyline

Side chair  
Silla

07610-00-00

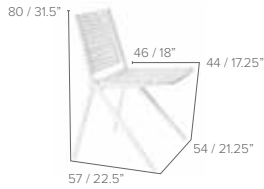

07610-10-10



07610-89-89



**D7610**  
Cover  
Funda

**C07610SW**  
Seat cushion  
Cojín de asiento



Armchair  
Silla con brazos

07618-00-00

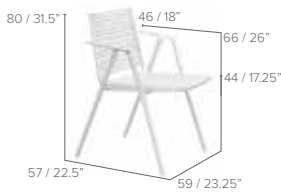

07618-10-10



07618-89-89



**D7618**  
Cover  
Funda

**C07610SW**  
Seat cushion  
Cojín de asiento



Adjustable lounger  
Tumbona reclinable

07640-00-00

07640-10-71\*\*  
\*\* 71 Silkgrey

07640-89-89

Up to 12 loungers  
hasta 12 tumbonas



**D7640**  
Cover  
Funda

**C07640W**  
Cushion  
Cojín







Aluminum, high pressure injected  
Aluminio inyectado a alta presión

Plantation teak from Java  
Teca de plantación de Java

Granite  
Granito

Table top: aluminum, teak or granite  
Tablero de mesa: aluminio, teca o granito

**Bistro table round**  
Mesa bistro redonda

75 / 29.5"  
72 / 28.25"

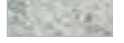

G-Granite  
G-Granito

dia 80cm/31.5" 07660-00-00  
dia 125cm/49.25" 07662-00-00

07660-10-10  
07662-10-10

07660-89-89  
07662-89-89

dia 80cm/31.5" 07660-00-T  
dia 125cm/49.25" 07662-00-T

07660-10-T  
07662-10-T

07660-89-T  
07662-89-T

dia 80cm/31.5" 07660-00-G  
dia 125cm/49.25" 07662-00-G

07660-10-G  
07662-10-G

07660-89-G  
07662-89-G

**Bistro table square**  
Mesa bistro cuadrada

75 / 29.5"  
72 / 28.25"



80x80cm/31.5x31.5" 07671-00-00  
90x90cm/35.5x35.5" 07670-00-00

07671-10-10  
07670-10-10

07671-89-89  
07670-89-89

80x80cm/31.5x31.5" 07671-00-T  
90x90cm/35.5x35.5" 07670-00-T

07671-10-T  
07670-10-T

07671-89-T  
07670-89-T

80x80cm/31.5x31.5" 07671-00-G  
90x90cm/35.5x35.5" 07670-00-G

07671-10-G  
07670-10-G

07671-89-G  
07670-89-G

**Dining table**  
Mesa de comedor

75 / 29.5"  
72 / 28.25"



Table top: aluminum or teak  
Tablero de mesa: aluminio o teca

210x98cm/82.75x38.5" 07652-00-00  
300x110cm/118x43.25" 07654-00-00

07652-10-10  
07654-10-10

07652-89-89  
07654-89-89

210x98cm/82.75x38.5" 07652-00-T  
300x110cm/118x43.25" 07654-00-T

07652-10-T  
07654-10-T

07652-89-T  
07654-89-T



		10-Linen	89-Wengé
	WEAVE		
FRAME			
	00-White	10-Linen	89-Wengé

Powdercoated stainless steel  
Acero inoxidable lacado al polvo

Plaited Tricord (polyolefin)  
Tricord trenzado (poliolefina)

\*Cat. F: Piping in Sunbrella fabric.  
\*Cat. F: Ribete en tela Sunbrella.

 Armchair  
Silla con brazos



**D1118**  
Cover  
Funda

**C01118SW**  
Seat cushion  
Cojín de asiento



 Bar chair  
Taburete alto



**D1116**  
Cover  
Funda

**C01118SW**  
Seat cushion  
Cojín de asiento





Powdercoated stainless steel      Plaited Tricord (polyolefin)  
 Acero inoxidable lacado al polvo      Tricord trenzado (poliolefina)

\*Cat. F: Piping in Sunbrella fabric.  
 \*Cat. F: Ribete en tela Sunbrella.

Lounge chair  
 Sillón Lounge



D1102  
 Cover  
 Funda

C01100BCAW  
 Back cushion casual  
 Cojín de respaldo casual

C01102SW  
 Seat cushion  
 Cojín de asiento



2-Seater sofa  
 Sofá 2 plazas



D1108  
 Cover  
 Funda

C01100BCAW  
 Back cushion Casual  
 Cojín de respaldo casual

Order 2x!

C01108SW  
 Seat cushion  
 Cojín de asiento





		10-Linen	89-Wengé
	WEAVE		
FRAME			
	00-White	10-Linen	89-Wengé

Powdercoated stainless steel  
Acero inoxidable lacado al polvo

Plaited Tricord (polyolefin)  
Tricord trenzado (poliolefina)

\*Cat. F: Piping in Sunbrella fabric.  
\*Cat. F: Ribete en tela Sunbrella.

 Meridienne right  
Diván con brazo derecho

01104-00-10



01104-10-10



01104-89-10



01104-10-89



01104-89-89



**D1104**  
Cover  
Funda

**C01100BCAW**

Back cushion Casual  
Cojín de respaldo casual

**C01104SW**

Seat cushion  
Cojín de asiento



 Meridienne left  
Diván con brazo izquierdo

01103-00-10



01103-10-10



01103-89-10



01103-10-89



01103-89-89



**D1103**  
Cover  
Funda

**C01100BCAW**

Back cushion Casual  
Cojín respaldo casual

**C01103SW**

Seat cushion  
Cojín de asiento









Plantation teak from Java  
Teca de plantación de Java

Plaited Tricord (polyolefin)  
Tricord trenzado (poliolefina)

Armchair  
Silla

02518-10



02518-89



**D2518**  
Cover  
Funda

**C02518SW**  
Seat cushion  
Cojín de asiento



Lounge chair  
Sillón bajo

02512-10



02512-89



**D2512**  
Cover  
Funda

**C02512SW**  
Seat cushion  
Cojín de asiento



Sofa 2-seater  
Sofá 2 plazas

02508-10



02508-89



**D2508**  
Cover  
Funda

**C02508SW**  
Seat cushion  
Cojín de asiento





Plantation teak from Java  
Teca de plantación de Java

Plaited Tricord (polyolefin)  
Tricord trenzado (poliolefina)

Lounge Chair High Back  
Sillón de respaldo alto

02520-10



02520-89



**D2520**  
Cover  
Funda

**C02520W**  
Cushion  
Cojín

**C02521BW**  
Back cushion  
Cojín de respaldo

**C02521SW**  
Seat cushion  
Cojín de asiento



Footstool  
Reposapiés

02590-10



02590-89



**D2590**  
Cover  
Funda

**C02590W**  
Seat cushion  
Cojín de asiento







Powdercoated aluminum  
Aluminio lacado al polvo

Batyline  
Batyline

\* 71-Canatex silkgrey  
\* 71-Canatex silkgrey

Adjustable lounger  
Tumbona reclinable

06040-00-00SB



06040-10-71S\*



06040-89-89S



**D6140**  
Cover  
Funda

**C06040W**  
Cushion  
Cojín





Aluminum, high pressure injected  
 Aluminio inyectado a alta presión

Batylite  
 Batylite

Plantation teak from Java  
 Teca de plantación de Java

\* Only for Armchair  
 \* Sólo para sillón

Armchair  
 Silla con brazos

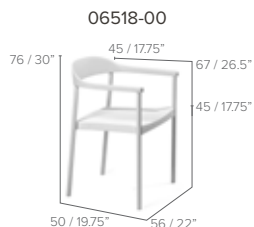

**D6518**  
 Cover  
 Funda

**C06518SW**  
 Cushion  
 Cojín



Bench, teak seat  
 Banco, asiento en teca



**D6534**  
 Cover  
 Funda

**C07434W**  
 Cushion\*  
 Cojín\*

\*42 x 42 cm, order 4x!  
 \*16.54" x 16.54"



Adjustable lounger  
 Tumbona reclinable

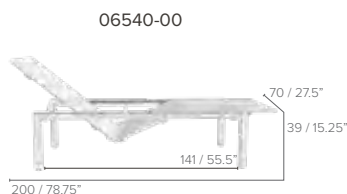

**D6540**  
 Cover  
 Funda

**C06540W**  
 Cushion  
 Cojín









# ILLUM TABLES

MERCKX & MAES

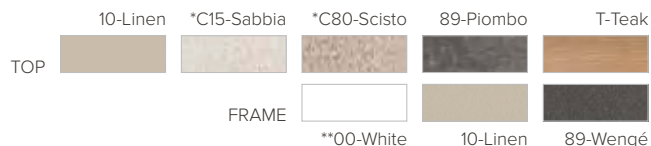

Aluminum, high pressure injected  
Aluminio, inyectado a alta presión

Plantation teak from Java  
Teca de plantación de Java

\*\*Not for counter height table  
\*\*No para la mesa altura mostrador

\*This color may possibly show delicate veins.  
\*Este color puede mostrar pequeñas vetas



Dining table  
Mesa de comedor

100x100cm/39.5x39.5"	06573-00-x	06573-10-x	06573-89-x
152x100cm/60x39.5"	06550-00-x	06550-10-x	06550-89-x
212x100cm/83.5x39.5"	06552-00-x	06552-10-x	06552-89-x
267x100cm/105x39.5"	06554-00-x	06554-10-x	06554-89-x
100x100cm/39.5x39.5"	06573-00-T	06573-10-T	06573-89-T
152x100cm/60x39.5"	06550-00-T	06550-10-T	06550-89-T
212x100cm/83.5x39.5"	06552-00-T	06552-10-T	06552-89-T
267x100cm/105x39.5"	06554-00-T	06554-10-T	06554-89-T
212x71cm/83.5x28"	06552xs-00-x	06552xs-10-x	06552xs-89-x
267x71cm/105x28"	06554xs-00-x	06554xs-10-x	06554xs-89-x
212x71cm/83.5x28"	06552xs-00-T	06552xs-10-T	06552xs-89-T
267x71cm/105x28"	06554xs-00-T	06554xs-10-T	06554xs-89-T

Dining table teak  
Mesa de comedor



100x100cm/39.5x39.5"	06573-T-x
152x100cm/60x39.5"	06550-T-x
212x100cm/83.5x39.5"	06552-T-x
267x100cm/105x39.5"	06554-T-x
100x100cm/39.5x39.5"	06573-T-T
152x100cm/60x39.5"	06550-T-T
212x100cm/83.5x39.5"	06552-T-T
267x100cm/105x39.5"	06554-T-T
212x73cm/83.5x28,75"	06552XS-T-x
212x73cm/83.5x28,75"	06552XS-T-T

Counter height table  
Mesa altura del mostrador



152x100cm/60x39.5"	06560-10-xx	06560-89-xx
212x71cm/83.5x28"	06564XS-10-xx	06564XS-89-xx
152x100cm/60x39.5"	06560-10-T	06560-89-T
212x71cm/83.5x28"	06564XS-10-T	06564XS-89-T

Note: the height and clearance under the table may differ according to the type of table top. Please consult the product sheet on our website.

Nota: la altura y el espacio libre debajo de la mesa pueden diferir según el tipo de tablero. Consulte la ficha del producto en nuestro sitio web.

Covers for tables see p.110  
Fundas para mesas consulte p.110



Plantation teak from Java  
Teca de plantación de Java

\* Cushion with overstitched pattern  
\* Cojín con adorno pespunte

Armchair  
Silla con brazos

04018



**D4018**  
Cover  
Funda

**C04018SW**  
Seat cushion\*  
Cojín de asiento\*



Lounge Chair  
Sillón bajo

04012



**D6038**  
Cover  
Funda

**C04012SW**  
Seat cushion\*  
Cojín de asiento\*



Footrest/side table  
Reposapiés/Mesa auxiliar

04090



**D6095**  
Cover  
Funda

**C04090W**  
Cushion\*  
Cojín\*



Bar chair  
Taburete alto

04016



**D4016**  
Cover  
Funda

**C04016SW**  
Seat cushion\*  
Cojín de asiento\*







Plantation teak from Java  
Teca de plantación de Java

⊖ Lounger, adjustable  
Tumbona reclinable

04040



**D6037**  
Cover  
Funda

**C04040W**  
Cushion\*  
Cojín\*



⌘ Bench  
Banco

04034



**D4034**  
Cover  
Funda

**C04034W**  
Cushion\*  
Cojín\*

\*42 x 42 cm, **order 3x!**  
16.54" x 16.54"



⌘ Dining Table  
Mesa de comedor



98x98cm/38.5x38.5"  
224x100cm/88x39.5"  
266x100cm/104.75x39.5"  
308x110cm/121.25x43.25"

04073



04052  
04053  
04054



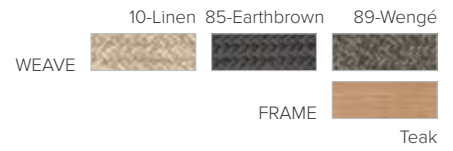

Plantation teak from Java  
Teca de plantación de Java

Plaited Tricord (polyolefin)  
Tricord trenzado (poliolefina)

Armchair  
Silla con brazos

06218-10



06218-85



06218-89



D6082  
Cover  
Funda

C06218BW  
Lumbar cushion  
Cojín lumbar

C06218SW  
Seat cushion  
Cojín de asiento



C06218BHW  
High back cushion  
Cojín de respaldo alto

C06218SW  
Seat cushion  
Cojín de asiento



C06218BCAW  
Back cushion Casual  
Cojín de respaldo casual

C06218SW  
Seat cushion  
Cojín de asiento



Bar chair  
Taburete alto

06216-10



06216-85



06216-89



D6088  
Cover  
Funda

C06218BW  
Lumbar cushion  
Cojín lumbar

C06218SW  
Seat cushion  
Cojín de asiento



C06218BHW  
High back cushion  
Cojín de respaldo alto

C06218SW  
Seat cushion  
Cojín de asiento



C06218BCAW  
Back cushion Casual  
Cojín de respaldo casual

C06218SW  
Seat cushion  
Cojín de asiento





Plantation teak from Java  
Teca de plantación de Java

Plaited Tricord (polyolefin)  
Tricord trenzado (poliolefina)

Lounge chair  
Sillón Lounge

06202-10



06202-85



06202-89



**D6080**  
Cover  
Funda

**C06202BW**  
Back cushion  
Cojín de respaldo

(58x36cm - 22.83x14.17")

**C06202SW**  
Seat cushion  
Cojín de asiento



**C06202BCAW**  
Back cushion Casual  
Cojín de respaldo casual

**C06202SW**  
Seat cushion  
Cojín de asiento





Plantation teak from Java  
Teca de plantación de Java

Plaited Tricord (polyolefin)  
Tricord trenzado (poliolefina)



Sofa 2-seater  
Sofá 2 plazas

06208-10



06208-85



06208-89



**D6085**  
Cover  
Funda

**C06208BSETW**  
Back cushion Set  
Cojín de respaldo Set

**C06208SW**  
Seat cushion  
Cojín de asiento



**C06208BCASETW**  
Back cushion Casual Set  
Cojín de respaldo casual Set

**C06208SW**  
Seat cushion  
Cojín de asiento



Sofa 3-seater  
Sofá 3 plazas

06209-10



06209-85



06209-89



**D6081**  
Cover  
Funda

**C06209BSETW**  
Back cushion Set  
Cojín de respaldo Set

**C06209SW**  
Seat cushion  
Cojín de asiento



**C06209BCASETW**  
Back cushion Casual Set  
Cojín de respaldo casual Set

**C06209SW**  
Seat cushion  
Cojín de asiento





Plantation teak from Java  
Teca de plantación de Java

Plaited Tricord (polyolefin)  
Tricord trenzado (poliolefina)

 Daybed  
Daybed

06249-10

06249-85

06249-89



**D6083**  
Cover  
Funda

**C06249BSETW**  
Back cushion Set  
Cojín de respaldo Set

**C06249SW**  
Seat cushion  
Cojín de asiento

**C06249BCASETW**  
Back cushion Casual Set  
Cojín de respaldo casual Set

**C06249SW**  
Seat cushion  
Cojín de asiento

For optimal comfort, we recommend completing the daybed with deco cushions. (page 101)  
Para una sensación acogedora, recomendamos completar el Daybed con diferentes cojines de decoración. (pag. 97)



 Lounge bed  
Cama lounge

06250-10

06250-85

06250-89



**D6087**  
Cover  
Funda

**C06250BSETW**  
Back cushion Set  
Cojín de respaldo Set

**C06250SW**  
Seat cushion  
Cojín de asiento

For optimal comfort, we recommend completing the daybed with deco cushions. (page 101)  
Para una sensación acogedora, recomendamos completar el Cama Lounge con diferentes cojines de decoración. (pag. 101)







Plantation teak from Java  
Teca de plantación de Java

Ottoman  
Ottoman



06282

**D6096**  
Cover  
Funda

**C06282W**

Seat cushion  
Cojín de asiento

66x66cm

**D6096C**  
Cover with Cushion  
Funda con cojín



Coffee table  
Mesita de salón



66cm/26"  
120cm/47.25"

06282



06284

**D6096**  
Cover 66cm/26"  
Funda 66cm/26"

**D6108**  
Cover 120cm/47.25"  
Funda 120cm/47.25"



# NATAL ALU

STUDIO SEGERS

Powdercoated aluminum  
Aluminio lacado al polvo

Batyliné  
Batyliné

\* Cushion with overstitched pattern  
\* Con adorno pespunte

 Armchair  
Silla con brazos

05918-89-89



**D6111**  
Cover  
Funda

**C03011W\***  
Cushion  
Cojín



 Lounge chair  
Sillón bajo

05912-89-89

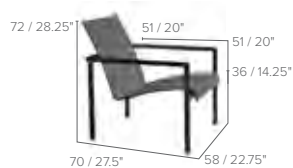

**D6074**  
Cover  
Funda

**C03019W\***  
Cushion  
Cojín



 Lounger, adjustable  
Tumbona, reclinable

05940-89-89



**D6073**  
Cover  
Funda

**C05440W**  
Cushion  
Cojín







ASIENTO STANDARD

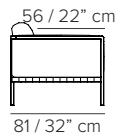

Powdercoated aluminum  
Aluminio lacado al polvo

Supporting straps in plaited textile  
Cintas de apoyo de fibra textileno trenzada

**STAND-ALONE**

	Armchair	2-Seater sofa	3-Seater sofa
Frame	05802-x	05808S-x	05809S-x
Cushion	C05802W	C05808SHW	C05809SHW
Cover	D5802	D5808SH	D5809SH

**MODULAR**

Cannot stand alone  
No se puede utilizar solo

	Right arm extension 2-Seater	Right arm corner module 2-Seater	Right corner extension 2-Seater	Centre module 2-Seater
Frame	05838RS-x	05848RS-x	05858RS-x	05828S-x
Cushion	C05838RSHW	C05848RSHW	C05858RSHW	C05828SHW

	Left arm extension 2-Seater	Left arm corner module 2-Seater	Left corner extension 2-Seater
Frame	05838LS-x	05848LS-x	05858LS-x
Cushion	C05838LSHW	C05848LSHW	C05858LSHW

	Right arm extension 3-Seater	Right arm corner module 3-Seater	Right corner extension 3-Seater	Centre module 3-Seater
Frame	05839RS-x	05849RS-x	05859RS-x	05829S-x
Cushion	C05839RSHW	C05849RSHW	C05859RSHW	C05829SHW

	Left arm extension 3-Seater	Left arm corner module 3-Seater	Left corner extension 3-Seater
Frame	05839LS-x	05849LS-x	05859LS-x
Cushion	C05839LSHW	C05849LSHW	C05859LSHW



# NATAL ALU SOFA DEEP

STUDIO SEGERS

NEW  10-Linen  89-Wengé

## ASIENTO PROFUNDO

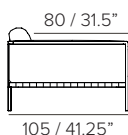

Powdercoated aluminum  
Aluminio lacado al polvo

Supporting straps in plaited textile  
Cintas de apoyo de fibra textileno trenzada

Casual back cushions (C02300W) recommended for optimal comfort.  
Cojines respaldo casual (C02300W) recomendados para una comodidad óptima.

### STAND-ALONE

	<p>2-Seater sofa</p>	<p>3-Seater sofa</p>
Frame	05808D-x	05809D-x
Cushion	C05808DW	C05809DW

### D5808D

### D5809D

### MODULAR

Cannot stand alone  
No se puede utilizar solo

	<p>Right arm extension 2-Seater</p>	<p>Right arm corner module 2-Seater</p>	<p>Right corner extension 2-Seater</p>	<p>Centre module 2-Seater</p>
Frame	05838RD-x	05848RD-x	05858RD-x	05828D-x
Cushion	C05838RDW	C05848RDW	C05858RDW	C05828DW

	<p>Left arm extension 2-Seater</p>	<p>Left arm corner module 2-Seater</p>	<p>Left corner extension 2-Seater</p>
Frame	05838LD-x	05848LD-x	05858LD-x
Cushion	C05838LDW	C05848LDW	C05858LDW

	<p>Right arm extension 3-Seater</p>	<p>Right arm corner module 3-Seater</p>	<p>Right corner extension 3-Seater</p>	<p>Centre module 3-Seater</p>
Frame	05839RD-x	05849RD-x	05859RD-x	05829D-x
Cushion	C05839RDW	C05849RDW	C05859RDW	C05829DW

	<p>Left arm extension 3-Seater</p>	<p>Left arm corner module 3-Seater</p>	<p>Left corner extension 3-Seater</p>
Frame	05839LD-x	05849LD-x	05859LD-x
Cushion	C05839LDW	C05849LDW	C05859LDW



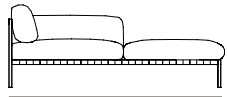

188 / 74" cm

Powdercoated aluminum  
Aluminio lacado al polvoSupporting straps in plaited textilene  
Cintas de apoyo de fibra textileno trenzada

## STAND-ALONE



Frame

05868-x

05869-x

Cushion

C05868W

C05869W

D5868

D5869

## MODULAR

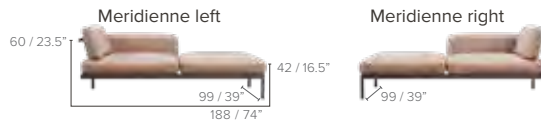
Cannot stand alone  
No se puede utilizar solo

Frame

05803-x

05804-x

Cushion

C05803W

C05804W

Connector\*  
Conector\*

A58C-X

\*A connector is required to connect two modules lengthwise.  
\*Se necesita un conector para unir dos módulos longitudinalmente.



# NATAL ALU SOFA SETS

STUDIO SEGERS

NEW  10-Linen  89-Wengé

Custom covers = \$255 per single seat and \$515 for meridienne and daybed modules  
Fundas a medida = \$255 por asiento individual y \$515 para módulos meridienne y daybed.

Deep Seat - Asiento profundo =  Arm Rest =   
Meridienne Seat - Meridienne =  Brazo

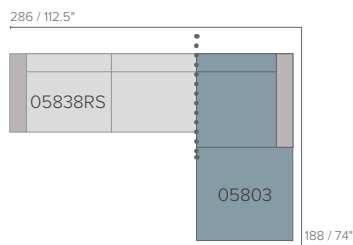

SET 1A  
Frame: 05838RS + 05803  
Cushions: C05838RSHW + C05803W

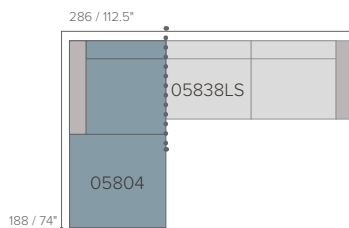

SET 1B  
Frame: 05838LS + 05804  
Cushions: C05838LSHW + C05804W

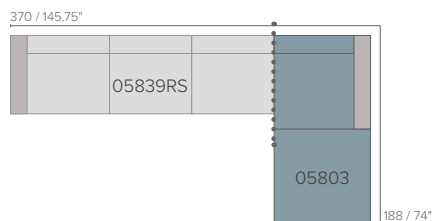

SET 2A  
Frame: 05839RS + 05803  
Cushions: C05839RSHW + C05803W

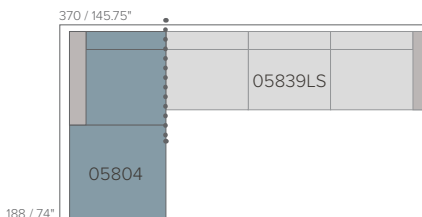

SET 2B  
Frame: 05839LS + 05804  
Cushions: C05839LSHW + C05804W

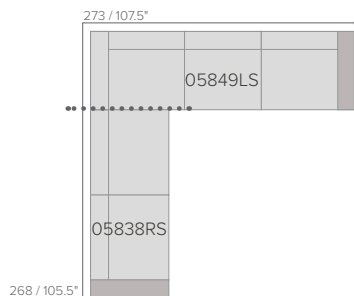

SET 3  
Frame: 05849LS + 05838RS  
Cushions: C05849LSHW + C05838RSHW

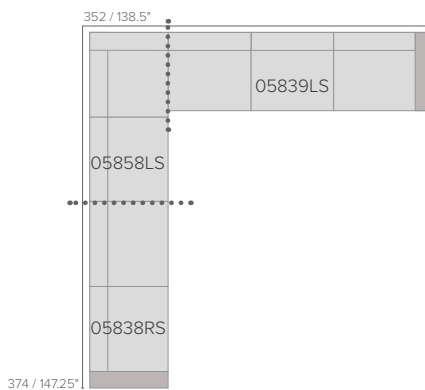

SET 4  
Frame: 05838RS + 05858LS + 05839LS  
Cushions: C05838RSHW + C05858LSHW + C05839LSHW  
Connector: A58C-x



Combination examples  
Ejemplos de combinaciones

Deep Seat - Asiento profundo =   
Meridienne Seat - Meridienne =

Arm Rest =   
Brazo

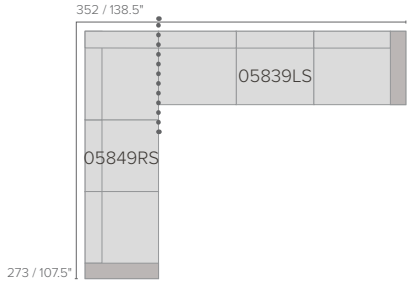

**SET 5A**  
Frame: 05849RS + 05839LS  
Cushions: C05849RSHW + C05839LSHW

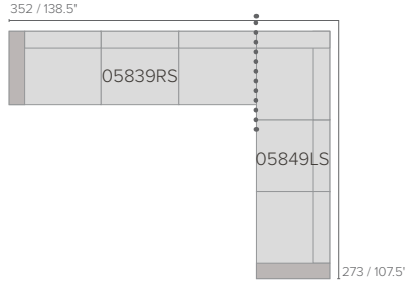

**SET 5B**  
Frame: 05839RS + 05849LS  
Cushions: C05839RSHW + C05849LSHW

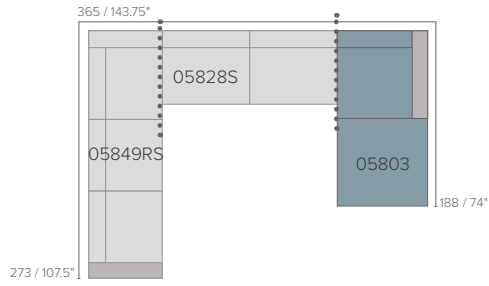

**SET 6A**  
Frame: 05849RS + 05828S + 05803  
Cushions: C05849RSHW + C05828SHW + C05803W

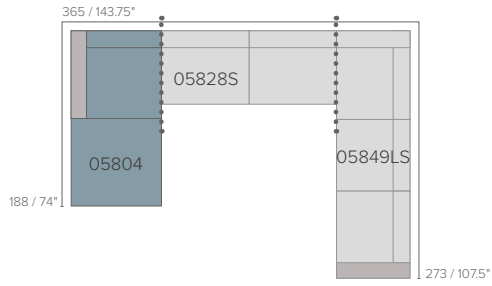

**SET 6B**  
Frame: 05804 + 05828S + 05849LS  
Cushions: C05804W + C05828SHW + C05849LSHW

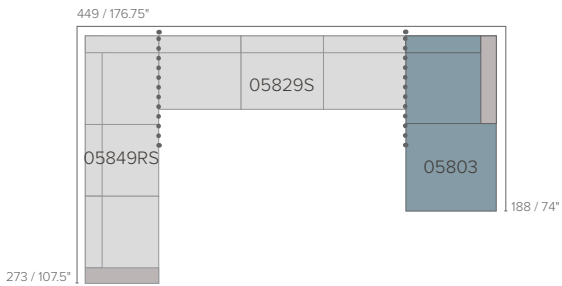

**SET 7A**  
Frame: 05849RS + 05829S + 05803  
Cushions A: C05849RSHW + C05829SHW + C05803W

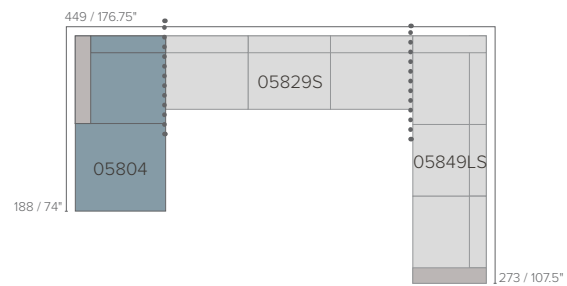

**SET 7B**  
Frame: 05804 + 05829S + 05849LS  
Cushions: C05804W + C05829SHW + C05849LSHW



# NATAL ALU SOFA SETS

STUDIO SEGERS

NEW  10-Linen  89-Wengé

35

Combination examples  
Ejemplos de combinaciones

Deep Seat - Asiento profundo =   
Meridienne Seat - Meridienne =   
Arm Rest = Brazo =

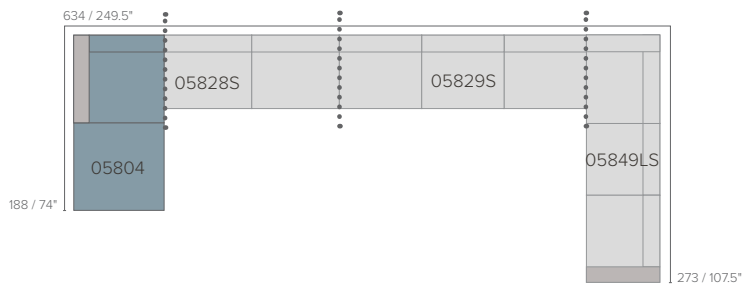

SET 9  
Frame: 05804 + 05828S + 05829S + 05849LS  
Cushions: C05804W + C05828SHW + C05829SHW + C05849LSHW  
Connector: A58C-x

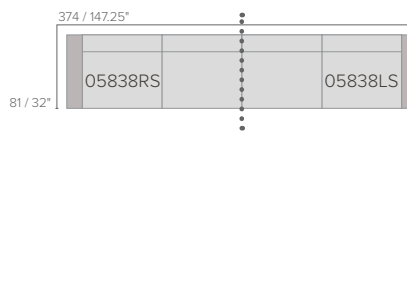

SET 10  
Frame: 05838RS + 05838LS  
Cushions: C05838RSHW + C05838LSHW  
Connector: A58C-x

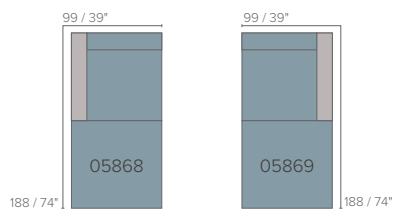

SET 11  
Frame: 05868 + 05869  
Cushions: C05868W + C05869W

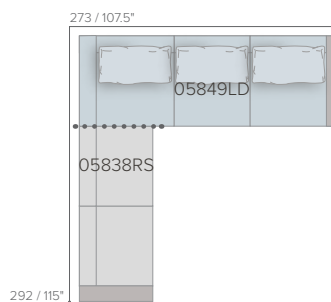

SET 12  
Frame: 05838RS + 05849LD  
Cushions: C05838RSHW + C05849LDW  
Casual back cushion: 3x C02300W

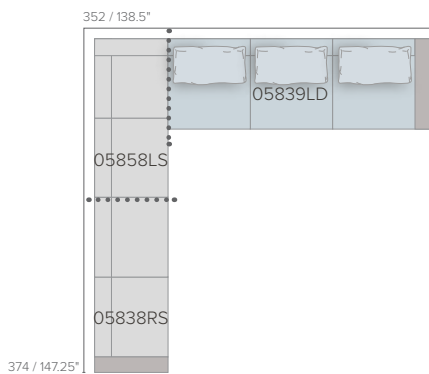

SET 13  
Frame: 05838RS + 05858LS + 05839LD  
Cushions: C05838RSHW + C05858LSHW + C05839LDW  
Casual back cushion: 3x C02300W  
Connector: A58C-x

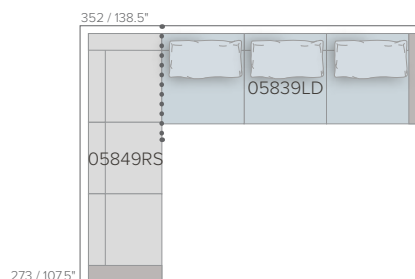

SET 14  
Frame: 05849RS + 05839LD  
Cushions: C05849RSHW + C05839LDW  
Casual back cushion: 3x C02300W



# NATAL ALU X TABLE

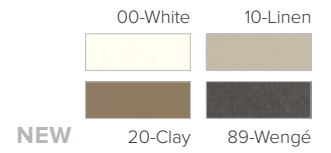

Powdercoated aluminum  
Aluminio lacado al polvo

Coffee table high round  
Mesa auxiliar alta redonda



**D6176**  
Cover  
Funda



Coffee table low 15.75"x 15.75"  
Mesa auxiliar baja 40x40cm

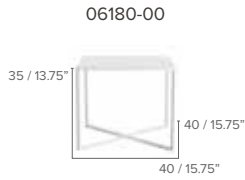

**D6180**  
Cover  
Funda



Coffee table low 23.5"x 23.5"  
Mesa auxiliar baja 60x60cm

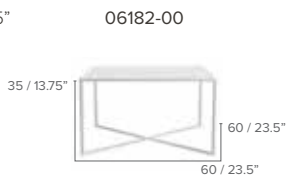

**D6182**  
Cover  
Funda





Powdercoated stainless steel    Canax®  
 Acero inoxidable lacado al polvo    Canax®

Armchair  
 Silla con brazo

01918-00-00/10



01918-89-10



**D1918**  
 Cover  
 Funda

**C01918SW**  
 Seat cushion  
 Cojín de asiento



Lounge chair  
 Sillón bajo

01912-00-00/10



01912-89-10



**D1912**  
 Cover  
 Funda

**C01912SW**  
 Seat cushion  
 Cojín de asiento



**L** Lounger, adjustable  
 Tumbona reclinable

01940-00-00/10



01940-89-10



**D1940**  
 Cover  
 Funda



**C01940W**  
 Seat cushion  
 Cojín de asiento







# NODI SOFA REGULAR YABU PUSHELBERG

00/10-Off-white + Linen      10-Linen

WEAVE  

FRAME  

00-White      89-Wengé

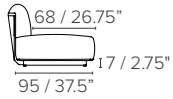

Powdercoated aluminum  
Aluminio lacado al polvo

Powdercoated stainless steel  
Acero inoxidable lacado al polvo

Canax®  
Canax®

Single module  
Módulo individual

01950-00-00/10



01950-89-10



**D1950**  
Cover  
Funda

**C01902BW**  
Back cushion  
Cojín de respaldo

**C01902SW**  
Seat cushion  
Cojín de asiento



Corner module  
Módulo esquinero

01951-x-y  
Left arm + Back



**C01902BW**  
Back cushion  
Cojín de respaldo

**C01902SW**  
Seat cushion  
Cojín de asiento

**D1951**



01952-x-y  
Right arm + Back



**C01902BW**  
Back cushion  
Cojín de respaldo

**C01902SW**  
Seat cushion  
Cojín de asiento

**D1952**



01953-x-y  
Left arm + Corner



**C01901BW**  
Corner Back cushion  
Cojín de esquina

**C01902SW**  
Seat cushion  
Cojín de asiento

**D1953**



01954-x-y  
Right arm + Corner



**C01901BW**  
Corner Back cushion  
Cojín de esquina

**C01902SW**  
Seat cushion  
Cojín de asiento

**D1954**



Pouf  
Puf

01955-00



01955-89



**D1955**  
Cover  
Funda

**C01902SW**  
Seat cushion  
Cojín de asiento



Corner Connector\*  
Conector de esquina\*

A1905-xx

\*A connector is needed to create a corner sofa.  
\*Se necesita una pieza de conexión para formar un sofá esquinero.



# NODI SOFA DEEP

YABU PUSHELBERG

	00/10-Off-white + Linen	10-Linen	
WEAVE			
FRAME			
	00-White	89-Wengé	

39

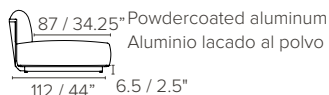

Powdercoated aluminum  
Aluminio lacado al polvo

Powdercoated stainless steel  
Acero inoxidable lacado al polvo

Canax®  
Canax®

Casual back cushions (C02300W) recommended for optimal comfort.  
Cojines respaldo casual (C02300W) recomendados para una comodidad óptima.

Single module deep  
Módulo individual profundo

01960-00-00/10



01960-89-10



**D1960**

Cover  
Funda

**C01902BW**

Back cushion  
Cojín de respaldo

**C01903SW**

Seat cushion  
Cojín de asiento

**C02300W**

Option Casual back cushion  
Opción Cojín de respaldo Casual



Corner module deep  
Módulo esquinero profundo

01961-x-y  
Left arm + Back



01962-x-y  
Right arm + Back



01963-x-y  
Left arm + Corner



01964-x-y  
Right arm + Corner



**C01902BW**  
Back cushion  
Cojín de respaldo

**C01902BW**  
Back cushion  
Cojín de respaldo

**C01901BW**  
Corner Back cushion  
Cojín de esquina

**C01901BW**  
Corner Back cushion  
Cojín de esquina

**C01903SW**  
Seat cushion  
Cojín de asiento

**C01903SW**  
Seat cushion  
Cojín de asiento

**C01903SW**  
Seat cushion  
Cojín de asiento

**C01903SW**  
Seat cushion  
Cojín de asiento

**D1961**



**D1962**



**D1963**



**D1964**



Pouf deep  
Puf profundo

01965-00



01965-89

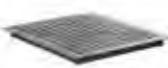

**D1965**

Cover  
Funda

**C01903SW**  
Seat cushion  
Cojín de asiento



Corner Connector\*  
Conector de esquina\*

A1905-xx

\*A connector is needed to create a corner sofa.  
\*Se necesita una pieza de conexión para formar un sofá esquinero.



	00/10-Off-white + Linen	10-Linen
WEAVE		
FRAME		
	00-White	89-Wengé

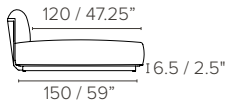

Powdercoated aluminum  
Aluminio lacado al polvo

Powdercoated stainless steel  
Acero inoxidable lacado al polvo

Canax®  
Canax®

Lounge daybed  
Lounge daybed

01970-00-00/10



01970-89-10



**D1970**  
Cover  
Funda

**C01902BW**  
Back cushion  
Cojín de respaldo

**C01904SW**  
Seat cushion  
Cojín de asiento



Lounge corner  
Lounge esquinero

01971-x-y  
Left arm + Back



**C01902BW**  
Back cushion  
Cojín de respaldo

**C01904SW**  
Seat cushion  
Cojín de asiento

**D1971**



01972-x-y  
Right arm + Back



**C01902BW**  
Back cushion  
Cojín de respaldo

**C01904SW**  
Seat cushion  
Cojín de asiento

**D1972**



01973-x-y  
Left arm + Corner



**C01901BW**  
Corner Back cushion  
Cojín de esquina

**C01904SW**  
Seat cushion  
Cojín de asiento

**D1973**



01974-x-y  
Right arm + Corner



**C01901BW**  
Corner Back cushion  
Cojín de esquina

**C01904SW**  
Seat cushion  
Cojín de asiento

**D1974**



Pouf lounge  
Puf lounge

01975-00



01975-89



**D1975**  
Cover  
Funda

**C01904SW**  
Seat cushion  
Cojín de asiento





# NODI SOFA MERIDIENNE

YABU PUSHELBERG

	00/10-Off-white + Linen	10-Linen
WEAVE		
FRAME	00-White	89-Wengé

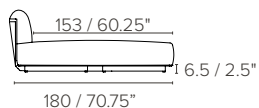

Powdercoated aluminum  
Aluminio lacado al polvo

Powdercoated stainless steel  
Acero inoxidable lacado al polvo

Canax®  
Canax®

Meridienne daybed  
Meridienne daybed

01980-00-00/10

01980-89-10



**D1980**  
Cover  
Funda

**C01902BW**  
Back cushion  
Cojín de respaldo

**C01905SW**  
Seat cushion  
Cojín de asiento



Meridienne corner  
Meridiano esquinero

01981-x-y  
Left arm + back

01982-x-y  
Right arm + Back

01983-x-y  
Left arm + Corner

01984-x-y  
Right arm + Corner



**C01902BW**  
Back cushion  
Cojín de respaldo

**C01902BW**  
Back cushion  
Cojín de respaldo

**C01901BW**  
Corner Back cushion  
Cojín de esquina

**C01901BW**  
Corner Back cushion  
Cojín de esquina

**C01905SW**  
Seat cushion  
Cojín de asiento

**C01905SW**  
Seat cushion  
Cojín de asiento

**C01905SW**  
Seat cushion  
Cojín de asiento

**C01905SW**  
Seat cushion  
Cojín de asiento



Pouf XL  
Puf XL

01985-00

01985-89



**D1985**  
Cover  
Funda

**C01905SW**  
Seat cushion  
Cojín de asiento



Corner Connector\*  
Conector de esquina\* A1905-xx

\*A connector is needed to create a corner sofa.  
\*Se necesita una pieza de conexión para formar un sofá esquinero.



Custom covers = \$255 per single seat and \$515 for meridienne and daybed modules  
 Fundas a medida = \$255 por asiento individual y \$515 para módulos meridienne y daybed.

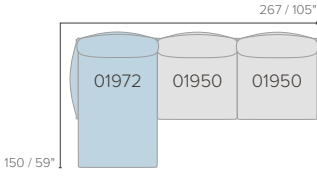
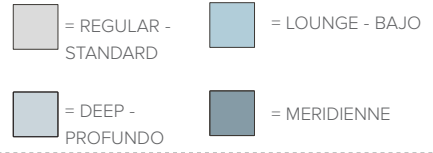

**SET 1**  
 Frame: 01972 + 2x 01950  
 Cushions: 3x C01902B + C01904S + 2x C01902S

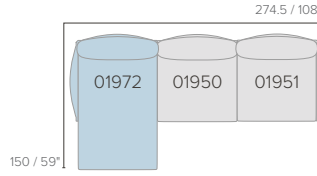

**SET 2**  
 Frame: 01972 + 01950 + 01951  
 Cushions: 3x C01902B + C01904S + 2x C01902S

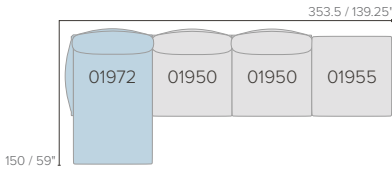

**SET 3**  
 Frame: 01972 + 2x 01950 + 01955  
 Cushions: 3x C01902B + C01904S + 3x C01902S

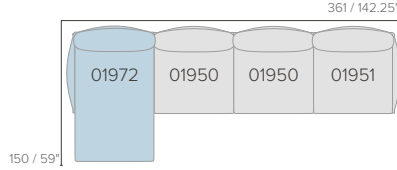

**SET 4**  
 Frame: 01972 + 2x 01950 + 01951  
 Cushions: 4x C01902B + C01904S + 3x C01902S

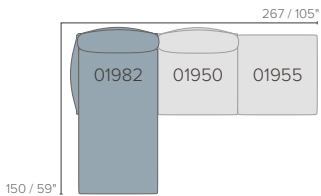

**SET 5**  
 Frame: 01982 + 01950 + 01955 + A1905  
 Cushions: 2x C01902B + C01905S + 2x C01902S

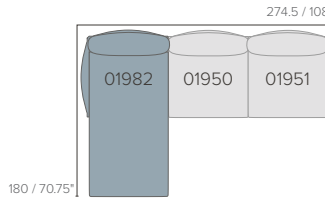

**SET 6**  
 Frame: 01982 + 01950 + 01951 + A1905  
 Cushions: 3x C01902B + C01905S + 2x C01902S



Combination examples  
Ejemplos de combinaciones

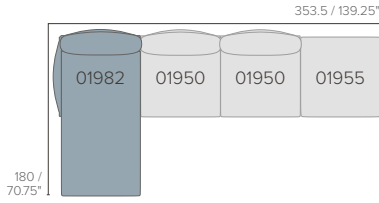
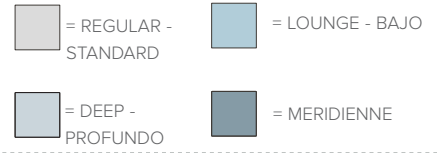

**SET 7**  
Frame: 01982 + 2x 01950 + 01955 + A1905  
Cushions: 3x C01902B + C01905S + 3x C01902S

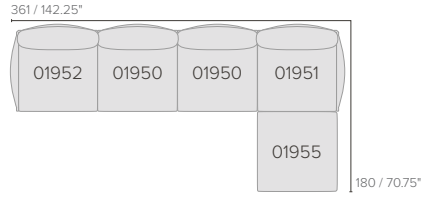

**SET 8**  
Frame: 01952 + 2x 01950 + 01951 + 01955 + A1905  
Cushions: 4x C01902B + 5x C01902S

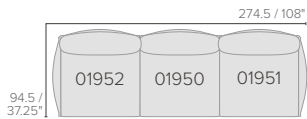

**SET 9**  
Frame: 01952 + 01950 + 01951  
Cushions: 3x C01902B + 3x C01902S

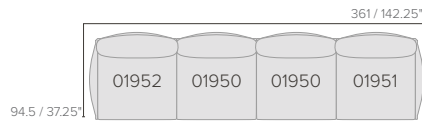

**SET 10**  
Frame: 01952 + 2x 01950 + 1x 01951  
Cushions: 4x C01902B + 4x C01902S

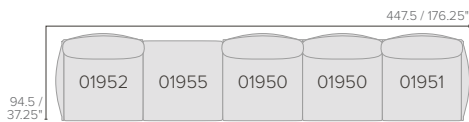

**SET 11**  
Frame: 01952 + 01955 + 2x 01950 + 1x 01951  
Cushions: 4x C01902B + 5x C01902S

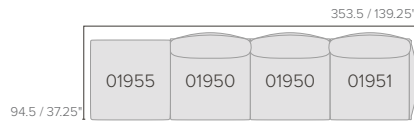

**SET 12**  
Frame: 01955 + 2x 01950 + 01951  
Cushions: 3x C01902B + 4x C01902S



Combination examples  
Ejemplos de combinaciones

= REGULAR - STANDARD      = LOUNGE - BAJO  
 = DEEP - PROFUNDO      = MERIDIENNE

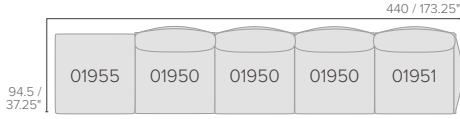

**SET 13**  
Frame: 01955 + 3x 01950 + 01951  
Cushions: 4x C01902B + 5x C01902S

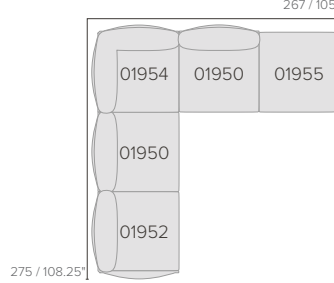

**SET 14**  
Frame: 01952 + 2x 01950 + 01954 + 01955 + A1905  
Cushions: C01901B + 3x C01902B + 5x C01902S

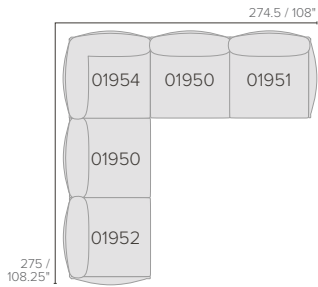

**SET 15**  
Frame: 01952 + 2x 01950 + 01954 + 01951 + A1905  
Cushions: C01901B + 4x C01902B + 5x C01902S

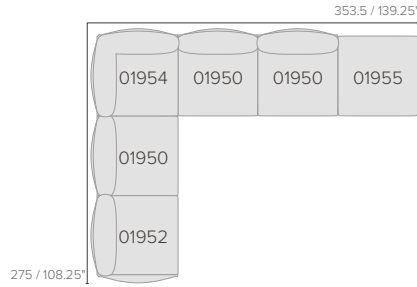

**SET 16**  
Frame: 01952 + 3x 01950 + 01954 + 01955 + A1905  
Cushions: C01901B + 4x C01902B + 6x C01902S

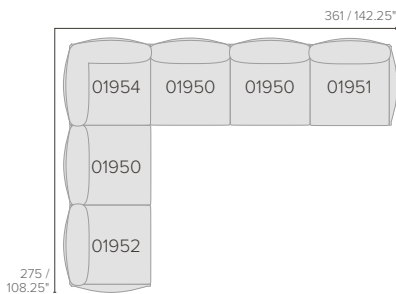

**SET 17**  
Frame: 01952 + 3x 01950 + 01954 + 01951 + A1905  
Cushions: C01901B + 5x C01902B + 6x C01902S

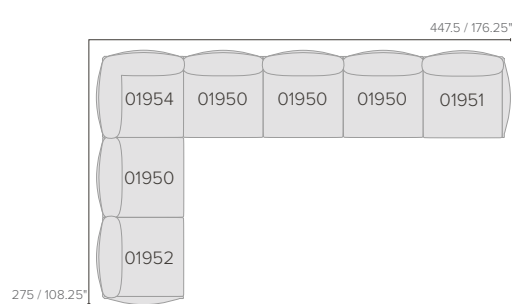

**SET 18**  
Frame: 01952 + 4x 01950 + 01954 + 01951 + A1905  
Cushions: C01901B + 6x C01902B + 7x C01902S



Combination examples  
Ejemplos de combinaciones

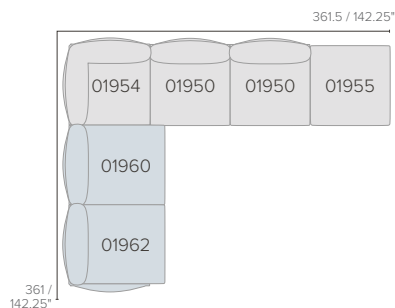
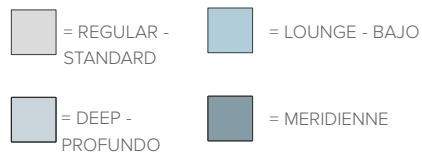

**SET 19**  
 Frame: 01962 + 01960 + 01954 + 2x 01950 + 01955 + A1905  
 Cushions: 2x C01903S + 4x C01902B + C01901B + 4x C01902S

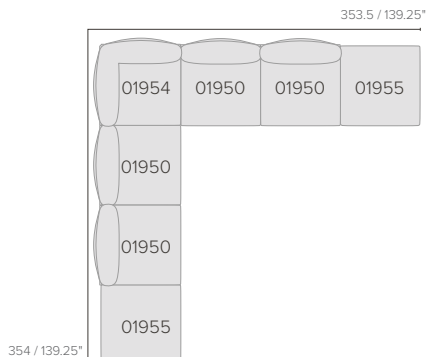

**SET 20**  
 Frame: 2x 01955 + 4x 01950 + 01954 + A1905  
 Cushions: C01901B + 4x C01902B + 7x C01902S

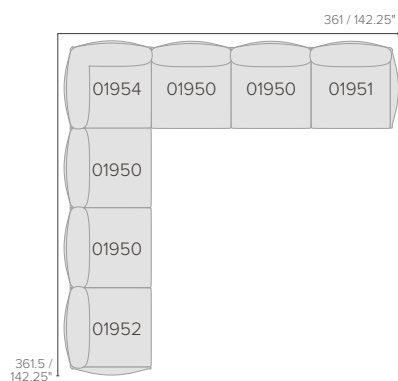

**SET 21**  
 Frame: 01952 + 4x 01950 + 01954 + 01951 + A1905  
 Cushions: C01901B + 6x C01902B + 7x C01902S

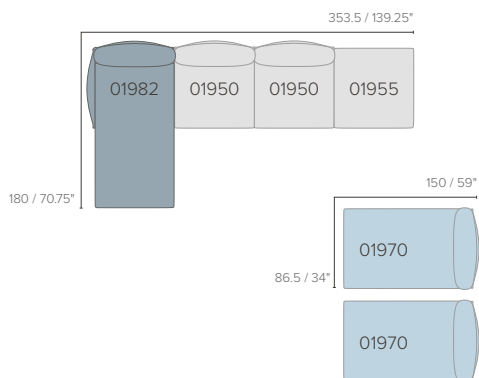

**SET 22**  
 Frame: 01982 + 2x 01950 + 01955 + 2x 01970 + A1905  
 Cushions: 5x C01902B + C01905S + 3x C01902S + 2x C01904S

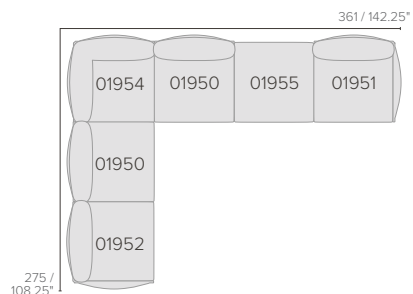

**SET 24**  
 Frame: 01952 + 2x 01950 + 01954 + 01955 + 01951 + A1905  
 Cushions: C01901B + 4x C01902B + 6x C01902S

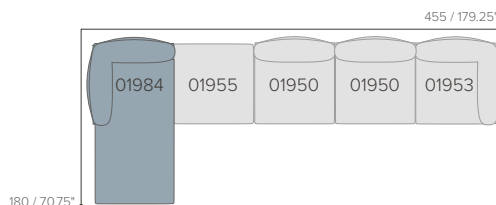

**SET 25**  
 Frame: 01984 + 01955 + 2x 01950 + 01953 + A1905  
 Cushions: C01905S + 4x C01902S + 2x C01901B + 2x C01902B





Plantation teak from Java  
Teca de plantación de Java

Armchair  
Silla con brazo

05018

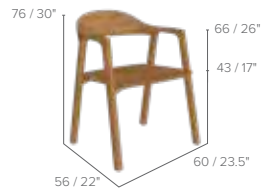

**D5024**  
Cover  
Funda

**C05018W**  
Seat & Back Cushion  
Cojín de asiento y respaldo

**C05018SW**  
Seat cushion  
Cojín de asiento



Lounge chair  
Sillón

05012



**D5012**  
Cover  
Funda

**C05012W**  
Seat & Back Cushion  
Cojín de asiento y respaldo

**C05012SW**  
Seat cushion  
Cojín de asiento





Powdercoated stainless steel  
Acero inoxidable lacado al polvo

Table top: glazed lava stone or ceramic  
Tablero de mesa: piedra de lava esmaltada o cerámica

\*This color may possibly show delicate veins.  
\*Este color puede mostrar pequeñas vetas

Dining table 104"  
Mesa de comedor 264 cm

x-Table top: glazed lava stone or ceramic  
x-Tablero de mesa: piedra de lava esmaltada o cerámica

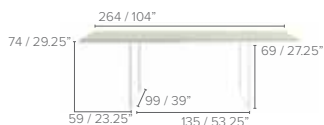

02252-00-Lx  
02252-00-Cx

02252-10-Lx  
02252-10-Cx

02252-89-Lx  
02252-89-Cx

Dining table 138,5"  
Mesa de comedor 352 cm



02254-00-Lx  
02254-00-Cx

02254-10-Lx  
02254-10-Cx

02254-89-Lx  
02254-89-Cx



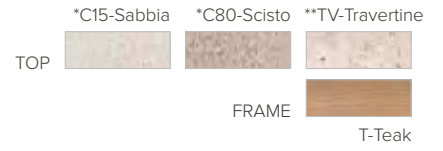

Plantation teak from Java  
Teca de plantación de Java

\* This material is sensitive to stains  
\* Este material es sensible a las manchas

\*This color may possibly show delicate veins.  
\*Este color puede mostrar pequeñas vetas

Dining Table - Dia 148cm



Ceramic  
Travertine

04266-Cx

04266-TV

Dining Table - 320x110cm

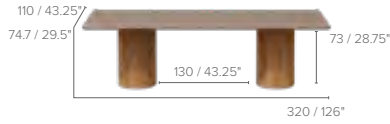

Ceramic

04254-Cx

Dining Table - 290x110cm  
Mesa de comedor 290x110cm

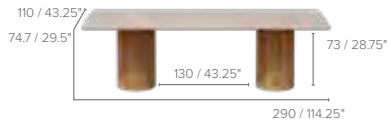

Travertine

04253-TV



Plantation teak from Java  
Teca de plantación de Java

\* This material is sensitive to stains  
\* Este material es sensible a las manchas

\*This color may possibly show delicate veins.  
\*Este color puede mostrar pequeñas vetas

Side Table - H32cm - H12.6"

Dia 48cm - Dia 19"



04281-Cx  
04281-T  
04281-TV

Ceramic  
Teak  
Travertine

Dia 60cm - Dia 23.5"



04283-Cx  
04283-T  
04283-TV

Ceramic  
Teak  
Travertine

Dia 90cm - Dia 35.5"

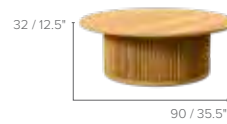

04284-Cx  
04284-T  
04284-TV

Ceramic  
Teak  
Travertine

Side Table - H45cm - H21.5"

Dia 48cm - Dia 19"



04280-Cx  
04280-T  
04280-TV

Ceramic  
Teak  
Travertine

Dia 60cm - Dia 23.5"



04282-Cx  
04282-T  
04282-TV

Ceramic  
Teak  
Travertine



Powdercoated aluminum  
Aluminio lacado al polvo

Plantation teak from Java  
Teca de plantación de Java

Sunscape  
Sunscape

Base  
Estructura

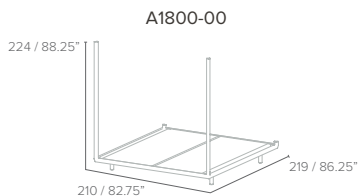

**D1800C**  
Cover\*  
Funda\*

**C01800SETW**  
Cushion Set (208x93x14cm)  
Cojín set (81.9x36.6x5.5")

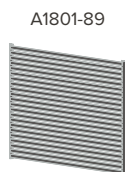
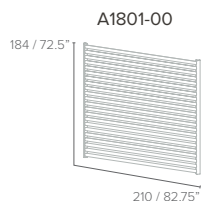

\*Cover: covers the cushions only and is included in the article ref. and the price of the frame structure.  
\*Funda - Cubre sólo los cojines y ya incluida en el código de artículo y el precio de la estructura.

Rear wall - Aluminum  
Pared posterior - Aluminio

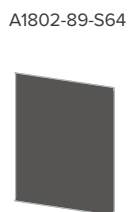

Rear wall - Sunscape  
Pared posterior - Sunscape

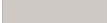

Sunscape:    
S54-Oyster S64-Nature Grey  
  
S70-stone

Rear wall - Teak  
Pared posterior - Teca

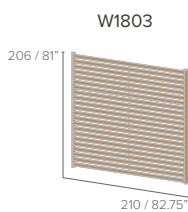

  
T-Teak

Rear wall - Empty  
Pared posterior - Abierta

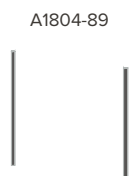
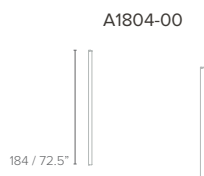



# PAVILION DAYBED

MONICA ARMANI

00-White

89-Wengé



Powdercoated aluminum  
Aluminio lacado al polvo

Plantation teak from Java  
Teca de plantación de Java

Sunbrella Sunscape  
Sunbrella Sunscape

Curtains in Sunbrella Velum  
Cortinas en Sunbrella Velum

Roof - Aluminum  
Techo - Aluminio

A1805-00

A1805-89

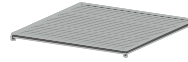
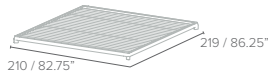

Roof - movable Sunscape  
Techo - Sunscape deslizante

A1807-00-S54  
A1807-00-S70

A1807-89-S64

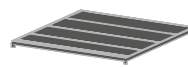
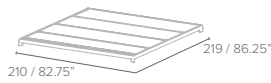

Sunscape:

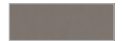
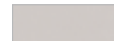

S54-Oyster

S64-Nature  
Grey



S70-stone

Roof - Teak  
Techo - Teca

W1808

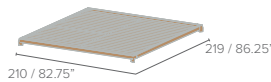

T-Teak

Curtain  
Cortina

P1809-V54

P1809-V64

P1809-V70

Set of 2 - Set de 2



Velum:

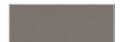

V54-Oyster

V64-Nature  
Grey



V70-Stone



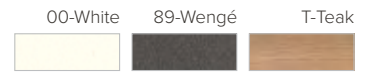

x: color base  
x: color estructura

y: color wall  
y: color pared posterior

z: color roof  
z: color techo

Cushions, curtains and side table should be ordered separately.  
Los cojines, cortinas y mesa de centro deben pedirse por separado.

Rear wall aluminium

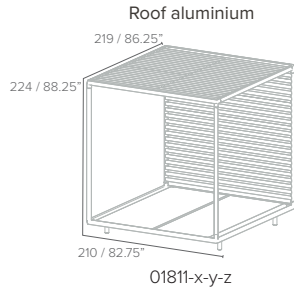

Cover included

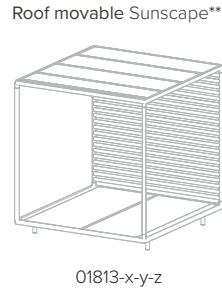

Cover included

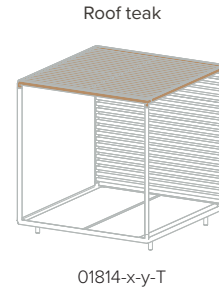

Cover included

Rear wall Sunscape\*\*



Cover included



Cover included

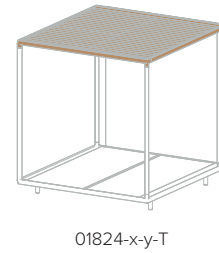

Cover included

Rear wall teak

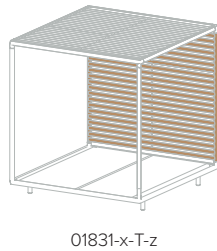

Cover included

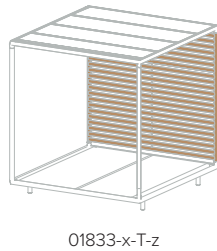

Cover included

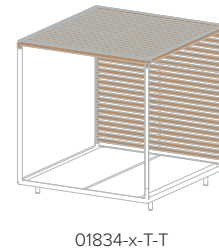

Cover included

Rear wall empty



Cover included

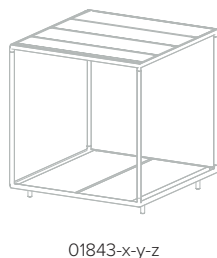

Cover included

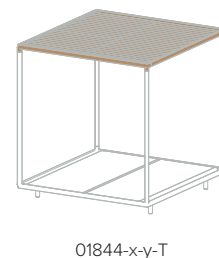

Cover included

\*\* Possible color combinations, see p. 50-51

\*\* Para posibles combinaciones de colores, ver p. 50-51



# PURE SOFA

ANDREI MUNTEANU

Teak



53

UPDATED

Plantation teak from Java  
Teca de plantación de Java

CASUAL STYLE:

Extra soft filling (Seat + back + armrests cushions)  
Con relleno extra suave (Cojín de asiento + respaldo + reposabrazos)

\*Extra back cushion for corner.  
\*Cojín adicional de respaldo

75.5x48x5cm

**C01201BCAW**



Corner sofa



Frame

01201

Corner sofa +  
corner cushion



01201

Armchair



01202s

C01202sCAW

Right arm sofa



Frame

01204

Right arm sofa +  
corner cushion



01204

C01215CAW

**NEW** Extension Double

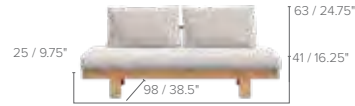

01228

C01228CAW

Corner Back Only  
**C01204BCAW**



Left arm sofa



Frame

01203

Left arm sofa +  
corner cushion



01203

C01215CAW

2-Seater sofa



Frame

01207

2-Seater sofa +  
corner cushion



01207

C01216CAW

Corner Back - Left Arm Only  
**C01208BCAW**

Corner Back - Right Arm Only  
**C01209BCAW**



C01206CAW

## OPTIONAL

Set of 2 connectors  
Conjunto de 2 conectores

R0022

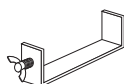

**C01200CAW**

Optional lumbar cushion.  
Cojín lumbar opcional





Plantation teak from Java  
Teca de plantación de Java

C-table teak  
Mesita-C teca



D6123  
Cover  
Funda

**NEW**

Lounger  
Tumbona



D1242  
Cover  
Funda

C01242W  
Cushion  
Cojín



**NEW**

Lounger  
Tumbona



01243 - with wheels\*  
01244 - with legs

D1242  
Cover  
Funda

C01242W  
Cushion  
Cojín

C01242W  
Cushion  
Cojín



The lounger is equipped with wheels positioned on the inside, allowing easy mobility.

La tumbona está equipada con ruedas situadas en el interior, lo que permite una fácil movilidad



# PURE SOFA

ANDREI MUNTEANU

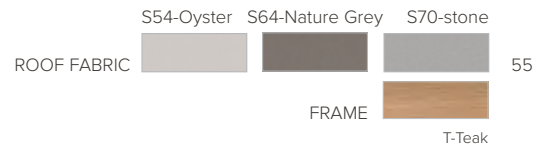

Plantation teak from Java  
Teca de plantación de Java

Roof in Sunscape  
Tejado en Sunscape

Curtains in Sunbrella Velum  
Cortinas en Sunbrella Velum

Cushions and curtains should be ordered separately  
Los cojines y cortinas deben pedirse por separado

**NEW** Cabana daybed  
Cabana daybed

01249-S54

01249-S64

01249-S70

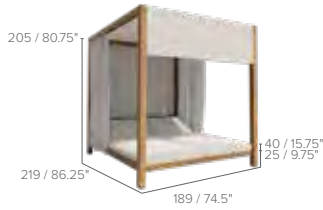

**D1249C**  
Cover\*  
Funda\*

**C01249SETW**  
Cushion  
Cojín

\*Cover: covers the cushions only and is included in the article ref. and the price of the frame structure.

\*Funda: Cubre sólo los cojines y ya incluida en el código de artículo y el precio de la estructura.

Curtain  
Cortina

P1209-V54

P1209-V64

P1209-V70

Set of 2 - Set de 2







56 **PURE SOFA SETS** ANDREI MUNTEANU

Combination examples  
Ejemplos de combinaciones

Custom covers = \$255 per single seat and \$515 for meridienne and daybed modules  
Fundas a medida = \$255 por asiento individual y \$515 para módulos meridienne y daybed.

 = CORNER CUSHION



**NEW SET 1**

frame: 1x 01204 - 1x 01201 - 1x 01228  
cushions: C01205CAW + C01211CAW + C01228CAW  
connectors: 2x



**SET 2**

frame: 2x 01203  
cushions: C01215CAW + C01205CAW  
connectors: 1x



**NEW SET 3**

frame: 1x 01228 - 1x 01204 - 1x 01203  
cushions: C01228CAW + C01215CAW + C01205CAW  
connectors: 2x



**SET 4**

frame: 1x 01207 - 2x 01202s  
cushions: C01206CAW + 2x C01202sCAW



**NEW**

**SET 5**

frame: 1x 01204 - 1x 01201 - 1x 01228 - 1x 01203  
cushions: 2x C01205CAW + C01211CAW + C01228CAW  
connectors: 3x



# PURE SOFA SETS

ANDREI MUNTEANU



Custom covers = \$255 per single seat and \$515 for meridienne and daybed modules  
 Fundas a medida = \$255 por asiento individual y \$515 para módulos meridienne y daybed.



**SET 8**  
 frame 1x 01204 - 1x 01203 - 1x 01201 - 1x 01202s  
 cushions 2x C01205CAW + C01211CAW + C01202sCAW  
 connectors: 2x

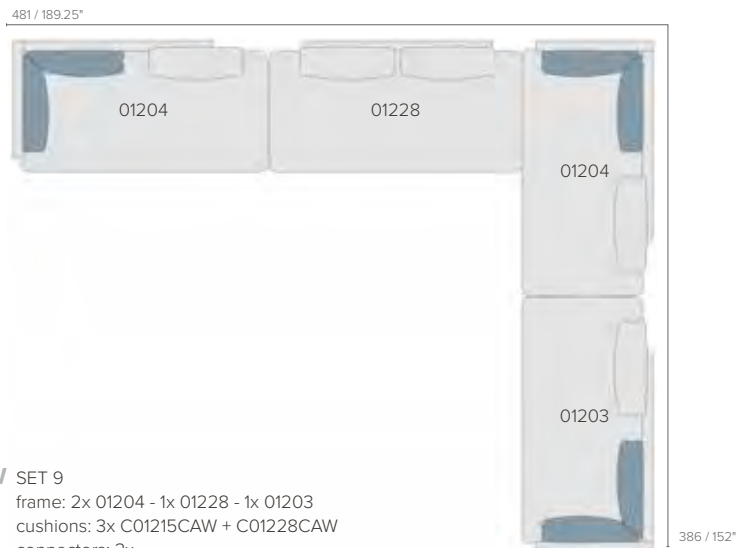

**NEW SET 9**  
 frame: 2x 01204 - 1x 01228 - 1x 01203  
 cushions: 3x C01215CAW + C01228CAW  
 connectors: 3x



**NEW SET 10**  
 frame: 1x 01204 - 1x 01249 - 1x 01228 - 1x 01203  
 cushions: 2x C01215CAW + C01249SETW + C01228CAW  
 connectors: 3x

**NEW SET 12**  
 frame: 2x 01204 - 1x 01243  
 cushions: 2x C01215CAW + C01242W  
 connectors: 2x





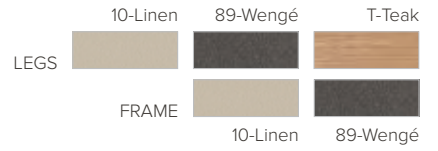

Powdercoated aluminum  
Aluminio lacado al polvo

Legs: powdercoated aluminum or teak (set of 4)  
Patatas: aluminio lacado al polvo o teca (set de 4)

Canax®  
Canax®

Armchair  
Silla con brazos

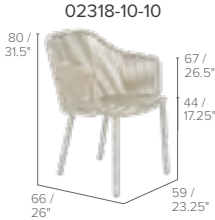

**D2318**  
Cover  
Funda

**C02318BW**  
Back cushion  
Cojín de respaldo

**C0001PW**  
Back cushion with piping  
Cojín de respaldo con ribete

Piping colors see page 101  
Color del ribete, ver página 101

**C02318SW**  
Seat cushion  
Cojín de asiento

**C02318SW**  
Seat cushion  
Cojín de asiento



Lounge chair  
Sillón

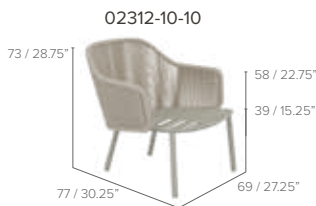

**D2316**  
Cover  
Funda

**C02312BW**  
Back cushion  
Cojín de respaldo

**C02312SW**  
Seat cushion  
Cojín de asiento





Powdercoated aluminum  
Aluminio lacado al polvo

Seat: Batyline®  
Asiento tumbona: Batyline®

Adjustable lounger  
Tumbona reclinable

02340-00

02340-10

02340-89

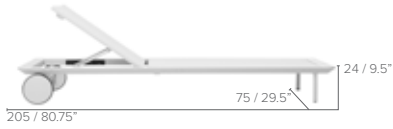

**D2340**  
Cover  
Funda

**C02340W**  
Cushion  
Cojín



Lounger with teak table top  
Tumbona con tablero en teca

02341-00

02341-10

02341-89



**D2341**  
Cover with table top  
Funda

**C02340W**  
Cushion  
Cojín





# SENJA SOFA REGULAR

STUDIO SEGERS



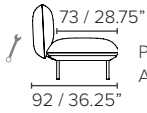
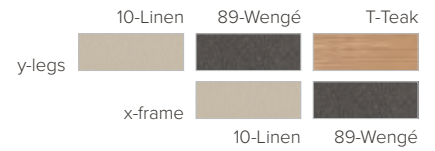







ASIENTO STANDARD

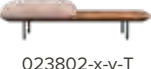

Powdercoated aluminum  
Aluminio lacado al polvo

Legs: powdercoated aluminum or teak (set of 4)  
Patas: aluminio lacado al polvo o teca (set de 4)

Casual back cushions (C02300W) recommended for optimal comfort.  
Cojines respaldo casual (C02300W) recomendados para una comodidad óptima.

	<b>Pouf module</b>	<b>Single module</b>	<b>1-Seater sofa arm high</b>	<b>1-Seater sofa arm low</b>	<b>Coffee table teak</b>	<b>Coffee table Lava stone</b>
						
Frame	023200-x-y	023201-x-y	023202-x-y	023203-x-y	023204-x-y-T	023205-x-y-Lx
Cushion	C023200W	C023201W	C023202W	C023203W		
Cover	D23200	D23201	D23202	D23203	D23204	D23204
	<b>Double pouf module</b>	<b>Pouf + teak table*</b>	<b>Single module + pouf*</b>	<b>Single module + teak table*</b>	<b>Double module</b>	
						
Frame	023801-x-y	023802-x-y-T	023803-x-y	023804-x-y-T	023805-x-y	
Cushion	C023801W	C023802W	C023803W	C023804W	C023805W	
Cover	D23801	D23802	D23803	D23804	D23805	
	<b>Right corner arm high</b>	<b>Left corner arm high</b>	<b>Right corner arm low</b>	<b>Left corner arm low</b>	<b>2-Seater arm high</b>	<b>2-Seater arm low</b>
						
Frame	023806-x-y	023807-x-y	023808-x-y	023809-x-y	023810-x-y	023811-x-y
Cushion	C023806W	C023807W	C023808W	C023809W	C023810W	C023811W
Cover	D23806	D23807	D23808	D23809	D23810	D23811
	<b>2-Seater right arm low</b>	<b>2-Seater left arm low</b>	<b>Right corner arm high + pouf</b>	<b>Left corner arm high + pouf</b>	<b>Right corner arm low + pouf</b>	<b>Left corner arm low + pouf</b>
						
Frame	023812-x-y	023813-x-y	023814-x-y	023815-x-y	023816-x-y	023817-x-y
Cushion	C023812W	C023813W	C023814W	C023815W	C023816W	C023817W
Cover	D23812	D23813	D23814	D23815	D23816	D23817
	<b>Right corner arm high + teak table</b>	<b>Left corner arm high + teak table</b>	<b>Right corner arm low + teak table</b>	<b>Left Corner arm low + teak table</b>	<b>Right corner back low + pouf</b>	<b>Left corner back low + pouf</b>
						
Frame	023818-x-y-T	023819-x-y-T	023820-x-y-T	023821-x-y-T	023822-x-y	023823-x-y
Cushion	C023818W	C023819W	C023820W	C023821W	C023822W	C023823W
Cover	D23818	D23819	D23820	D23821	D23822	D23823

\*This module can also be mirrored.  
\* Este módulo es igual en ambas direcciones.



# SENJA SOFA REGULAR

STUDIO SEGERS

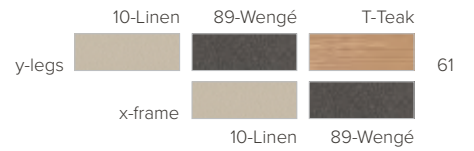



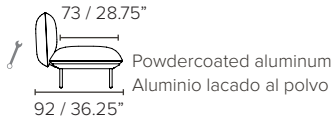



















61



Legs: powdercoated aluminum or teak (set of 4)  
Patas: aluminio lacado al polvo o teca (set de 4)

Casual back cushions (C02300W) recommended for optimal comfort.  
Cojines respaldo casual (C02300W) recomendados para una comodidad óptima.

	<b>Triple pouf module</b>	<b>Triple module</b>	<b>3-Seater arm high</b>	<b>3-Seater arm low</b>	<b>3-Seater right arm low</b>
					
Frame	023901-x-y	023902-x-y	023903-x-y	023904-x-y	023905-x-y
Cushion	C023901W	C023902W	C023903W	C023904W	C023905W
Cover	D23901	D23902	D23903	D23904	D23905
	<b>3-Seater left arm low</b>	<b>Right extension + pouf</b>	<b>Left extension + pouf</b>	<b>Right extension + teak table</b>	<b>Left extension + teak table</b>
					
Frame	023906-x-y	023907-x-y	023908-x-y	023909-x-y-T	023910-x-y-T
Cushion	C023906W	C023907W	C023908W	C023909W	C023910W
Cover	D23906	D23907	D23908	D23909	D23910
	<b>Right corner arm high</b>	<b>Left corner arm high</b>	<b>Right corner arm low</b>	<b>Left corner arm low</b>	
					
Frame	023911-x-y	023912-x-y	023913-x-y	023914-x-y	
Cushion	C023911W	C023912W	C023913W	C023914W	
Cover	D23911	D23912	D23913	D23914	
	<b>Right corner arm high + pouf</b>	<b>Left corner arm high + pouf</b>	<b>Right corner arm low + pouf</b>	<b>Left corner arm low + pouf</b>	
					
Frame	023915-x-y	023916-x-y	023917-x-y	023918-x-y	
Cushion	C023915W	C023916W	C023917W	C023918W	
Cover	D23915	D23916	D23917	D23918	
	<b>Right corner arm high + teak table</b>	<b>Left corner arm high + teak table</b>	<b>Right corner arm low + teak table</b>	<b>Left corner arm low + teak table</b>	
					
Frame	023919-x-y-T	023920-x-y-T	023921-x-y-T	023922-x-y-T	
Cushion	C023919W	C023920W	C023921W	C023922W	
Cover	D23919	D23920	D23921	D23922	



62 **SENJA SOFA DEEP** STUDIO SEGERS

ASIENTO PROFUNDO

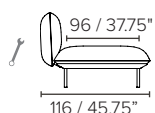
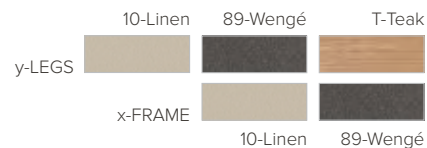

Powdercoated aluminum  
Aluminio lacado al polvo

Legs: powdercoated aluminum or teak (set of 4)  
Patatas: aluminio lacado al polvo o teca (set de 4)

Casual back cushions (C02300W) recommended for optimal comfort.  
Cojines respaldo casual (C02300W) recomendados para una comodidad óptima.

	Double pouf module	Pouf + teak table*	Single module + pouf*	Single module + teak table*	Double module	
Frame	 023851-x-y	 023852-x-y-T	 023853-x-y	 023854-x-y-T	 023855-x-y	
Cushion	C023851W	C023852W	C023853W	C023854W	C023855W	*This module can also be mirrored. * Este módulo es igual en ambas direcciones.
Cover	D23851	D23852	D23853	D23854	D23855	

	Right corner arm high	Left corner arm high	Right corner arm low	Left corner arm low	2-Seater arm high	2-Seater arm low
Frame	 023856-x-y	 023857-x-y	 023858-x-y	 023859-x-y	 023860-x-y	 023861-x-y
Cushion	C023856W	C023857W	C023858W	C023859W	C023860W	C023861W
Cover	D23856	D23857	D23858	D23859	D23860	D23861

	2-Seater right arm low	2-Seater left arm low	Right corner arm high + pouf	Left corner arm high + pouf	Right corner arm low + pouf	Left corner arm low + pouf
Frame	 023862-x-y	 023863-x-y	 023864-x-y	 023865-x-y	 023866-x-y	 023867-x-y
Cushion	C023862W	C023863W	C023864W	C023865W	C023866W	C023867W
Cover	D23862	D23863	D23864	D23865	D23866	D23867

	Right corner arm high + teak table	Left corner arm high + teak table	Right corner arm low + teak table	Left corner arm low + teak table
Frame	 023868-x-y-T	 023869-x-y-T	 023870-x-y-T	 023871-x-y-T
Cushion	C023868W	C023869W	C023870W	C023871W
Cover	D23868	D23869	D23870	D23871



# SENJA SOFA DEEP





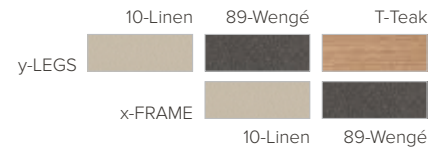

















STUDIO SEGERS

ASIENTO PROFUNDO



Legs: powdercoated aluminum or teak (set of 4)  
Patatas: aluminio lacado al polvo o teca (set de 4)

Casual back cushions (C02300W) recommended for optimal comfort.  
Cojines de respaldo casual (C02300W) recomendados para una comodidad óptima.

	<p>Triple pouf module</p>  <p>39 / 15.25" 253 / 99.5"</p>	<p>Triple module</p> 	<p>3-Seater arm high</p>  <p>288 / 113.5"</p>	<p>3-Seater arm low</p> 	<p>3-Seater right arm low</p> 
Frame	023951-x-y	023952-x-y	023953-x-y	023954-x-y	023955-x-y
Cushion	C023951W	C023952W	C023953W	C023954W	C023955W
Cover	D23951	D23952	D23953	D23954	D23955
	<p>3-Seater left arm low</p>  <p>77 / 30.25" 287 / 113"</p>	<p>Right extension + pouf</p>  <p>62 / 24.5" 252 / 99.25"</p>	<p>Left extension + pouf</p> 	<p>Right extension + teak table</p> 	<p>Left extension + teak table</p> 
Frame	023956-x-y	023957-x-y	023958-x-y	023959-x-y-T	023960-x-y-T
Cushion	C023956W	C023957W	C023958W	C023959W	C023960W
Cover	D23956	D23957	D23958	D23959	D23960
	<p>Right corner arm high</p>  <p>77 / 30.25" 270 / 106.25"</p>	<p>Left corner arm high</p> 	<p>Right corner arm low</p> 	<p>Left corner arm low</p> 	
Frame	023961-x-y	023962-x-y	023963-x-y	023964-x-y	
Cushion	C023961W	C023962W	C023963W	C023964W	
Cover	D23961	D23962	D23963	D23964	
	<p>Right corner arm high + pouf</p>  <p>77 / 30.25" 270 / 106.25"</p>	<p>Left corner arm high + pouf</p>  <p>39 / 15.25"</p>	<p>Right corner arm low + pouf</p> 	<p>Left corner arm low + pouf</p> 	
Frame	023965-x-y	023966-x-y	023967-x-y	023968-x-y	
Cushion	C023965W	C023966W	C023967W	C023968W	
Cover	D23965	D23966	D23967	D23968	
	<p>Right corner arm high + teak table</p>  <p>77 / 30.25" 270 / 106.25"</p>	<p>Left corner arm high + teak table</p>  <p>28 / 11"</p>	<p>Right corner arm low + teak table</p> 	<p>Left corner arm low + teak table</p> 	
Frame	023969-x-y-T	023970-x-y-T	023971-x-y-T	023972-x-y-T	
Cushion	C023969W	C023970W	C023971W	C023972W	
Cover	D23969	D23970	D23971	D23972	



# 64 SENJA SOFA MERIDIENNE

STUDIO SEGERS

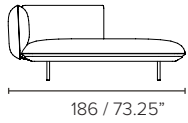
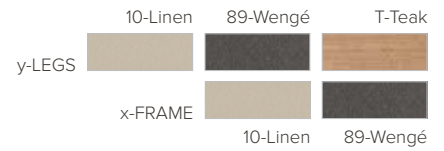

Powdercoated aluminum  
Aluminio lacado al polvo

Legs: powdercoated aluminum or teak (set of 4)  
Patas: aluminio lacado al polvo o teca (set de 4)

Casual back cushions (C02300W) recommended for optimal comfort.  
Cojines de respaldo casual (C02300W) recomendados para una comodidad óptima.

	Meridienne left arm high	Meridienne left arm low	Meridienne right arm high	Meridienne right arm low	Meridienne daybed
Frame	023301-x-y	023302-x-y	023401-x-y	023402-x-y	023403-x-y
Cushion	C023301W	C023302W	C023401W	C023402W	C023403W

Cover	D23301	D23302	D23401	D23402	D23403
-------	--------	--------	--------	--------	--------

Casual back cushion  
Cojín de respaldo Casual\*  
68x45x15cm  
26.75x17.75x6"

C02300W



Cat D  
Cat E  
Cat F

Separate Arm/Backrests  
Brazo/Respaldo por separado

Price on request  
Precio a consultar

Console table  
Mesa consola

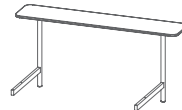
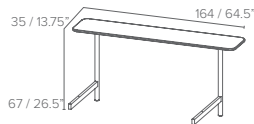

Table: glazed lava stone or teak  
Tablero de mesa: piedra de lava esmaltada o teca



Lava stone	02387-10-Lx	02387-89-Lx
Teak	02387-10-T	02387-89-T

D2387CONSOLE  
Cover  
Funda

Side table  
Mesa lateral

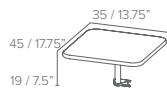

Lava stone	02381-10-Lx	02381-89-Lx
teak	02381-10-T	02381-89-T

D2381SIDE  
Cover  
Funda

Table top regular  
Tablero de mesa estándar



Table: glazed lava stone or teak  
Tablero de mesa: piedra de lava esmaltada o teca

Lava stone	02370S-10-Lx	02370S-89-Lx
------------	--------------	--------------

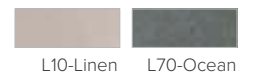
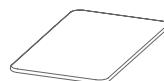
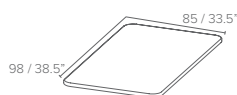

Table top deep  
Tablero de mesa profundo



Lava stone	02370D-10-Lx	02370D-89-Lx
------------	--------------	--------------



This is an additional cost versus the price for teak (regular p60-61 & deep p62-63)





Este suplemento adicional es debido a la diferencia de precio entre teca y lavastone (estándar p60-61 & profundo p62-63)







The table tops mentioned are in teak. For lava stone there is an additional cost.  
 Los tableros mencionados son de teca. Para la piedra de lava hay un coste adicional.

-  = ARM LOW  
Brazo bajo
-  = SEAT DEPTH: DEEP  
Asiento profundo
-  = TABLE  
= Mesa
-  = TABLE DEEP  
= Mesa profunda

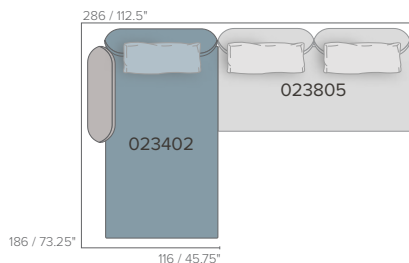

**SET 1**  
 Frame: 023402 + 023805  
 Cushions: C023402W + C023805W  
 Casual back cushions: 3x C02300W

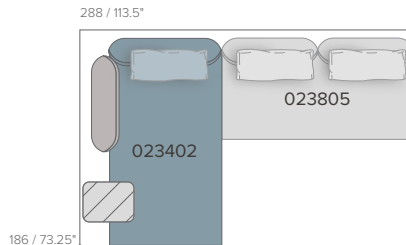

**SET 2**  
 Frame: 023402 + 023805  
 Cushions: C023402W + C023805W  
 Sidetable: 02381-T  
 Casual back cushions: 3x C02300W

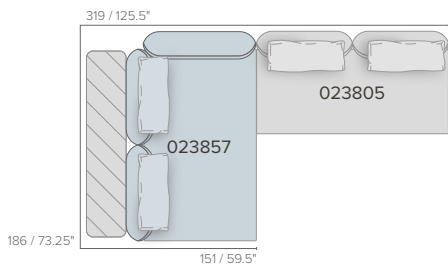

**SET 3**  
 Frame: 023857 + 023805  
 Cushions: C023857W + C023805  
 Table: 02387-T  
 Casual back cushions: 4x C02300W

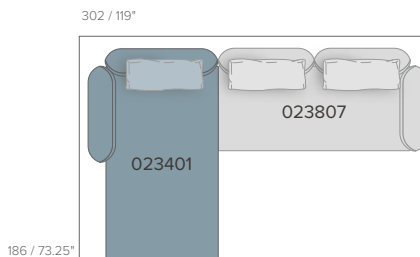

**SET 4**  
 Frame: 023401 + 023807  
 Cushions: C023401W + C023807W  
 Casual back cushions: 3x C02300W

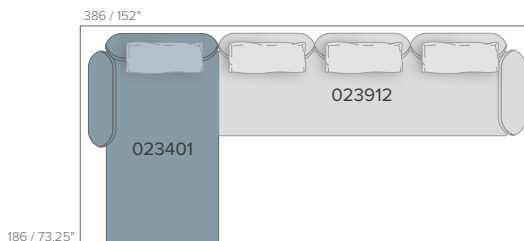

**SET 5**  
 Frame: 023401 + 023912  
 Cushions: C023401W + C023912W  
 Casual back cushions: 4x C02300W

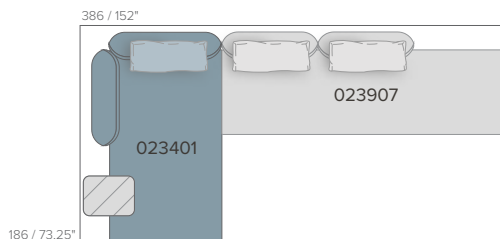





**SET 6**  
 Frame: 023401 + 023907  
 Cushions: C023401W + C023907W  
 Sidetable: 02381-T  
 Casual back cushions: 3x C02300W



# SENJA SOFA SETS STUDIO SEGERS

Custom covers = \$255 per single seat/table and \$515 for meridienne and daybed modules  
 Fundas a medida = \$255 por asiento individual/mesita y \$515 para módulos meridienne y daybed.

 = ARM LOW Braso bajo	 = SEAT DEPTH: DEEP Asiento profundo
 = TABLE = Mesa	 = TABLE DEEP = Mesa profunda

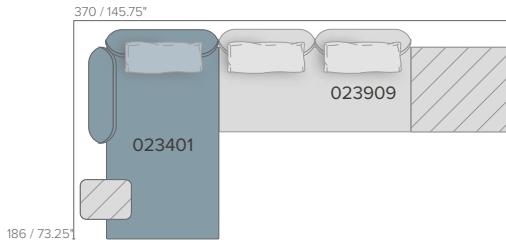

**SET 7**  
 Frame: 023401 + 023909  
 Cushions: C023401W + C023909W  
 Sidetable: 02381-T  
 Casual back cushions: 3x C02300W

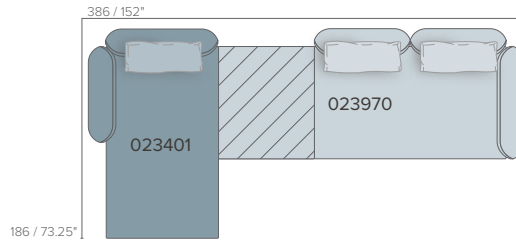

**SET 8**  
 Frame: 023401 + 023970  
 Cushions: C023401W + C023970W + 2x C02300W  
 Casual back cushions: 3x C02300W

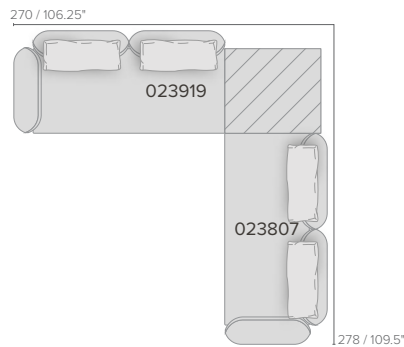

**SET 9**  
 Frame: 023919 + 023807  
 Cushions: C023919W + C023807W  
 Casual back cushions: 4x C02300W

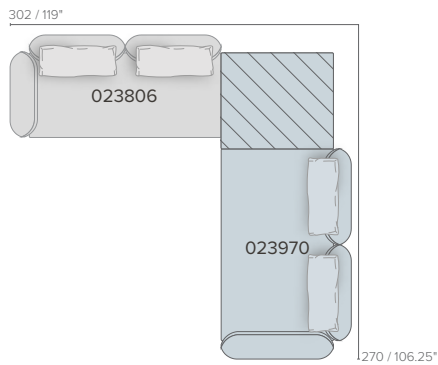

**SET 10**  
 Frame: 023806 + 023970  
 Cushions: C023806W + C023970W  
 Casual back cushions: 4x C02300W

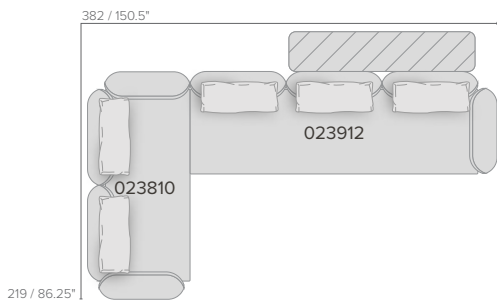



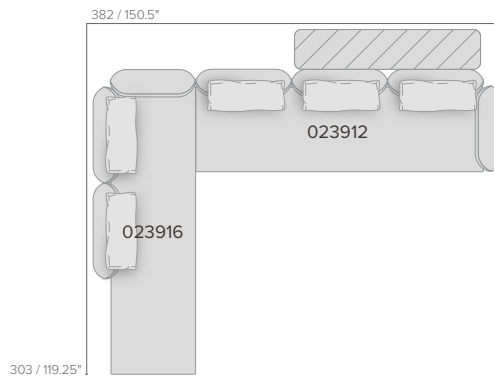

**SET 11**  
 Frame: 023810 + 023912  
 Cushions: C023810W + C023912W  
 Table: 02387-T  
 Casual back cushions: 5x C02300W



**SET 12**  
 Frame: 023916 + 023912  
 Cushions: C023916W + C023912W  
 Table: 02387-T  
 Casual back cushions: 5x C02300W



The table tops mentioned are in teak. For lava stone there is an additional cost.  
 Los tableros mencionados son de teca. Para la piedra de lava hay un coste adicional.

	= ARM LOW Brazo bajo		= SEAT DEPTH: DEEP Asiento profundo
	= TABLE Mesa		= TABLE DEEP Mesa profunda

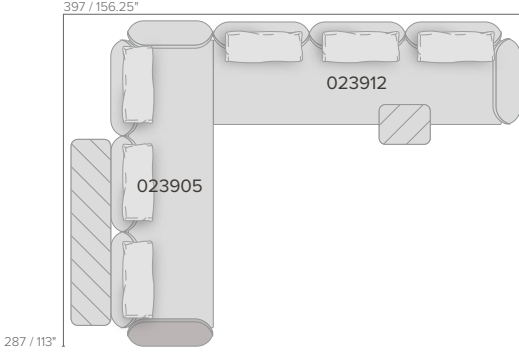

**SET 13**  
 Frame: 023905 + 023912  
 Cushions: C023905W + C023912W  
 Tables: 02387-T + 02381-T  
 Casual back cushions: 6x C02300W

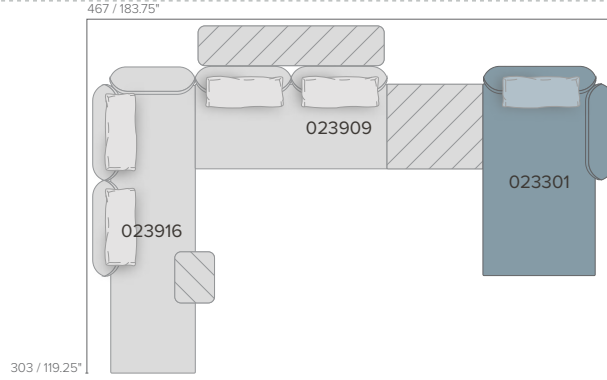

**SET 14**  
 Frame: 023916 + 023909 + 023301  
 Cushions: C023916W + C023909W + C023301W  
 Tables: 02381-T + 02387-T  
 Casual back cushions: 5x C02300W

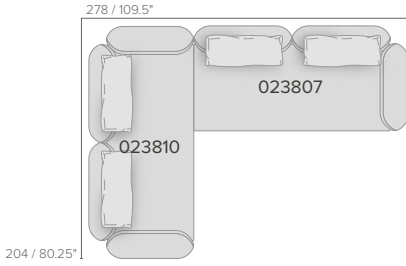

**SET 15**  
 Frame: 023810 + 023807  
 Cushions: C023810W + C023807W  
 Casual back cushions: 4x C02300W

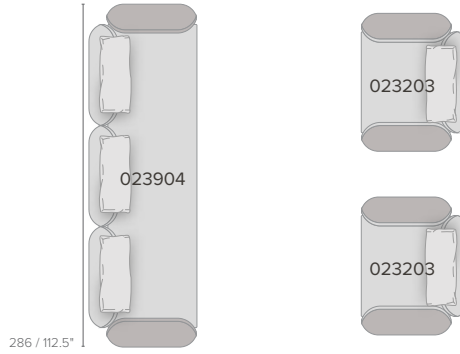

**SET 16**  
 Frame: 023904+ 2x 023203  
 Cushions: C023904W + 2x C023203W  
 Casual back cushions: 5x C02300W

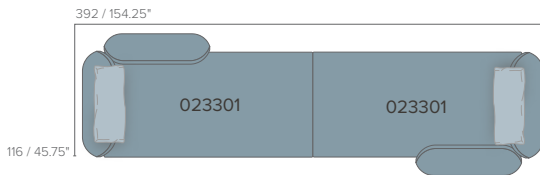

**SET 17**  
 Frame: 2x 023301  
 Cushions: 2x C023301W  
 Casual back cushions: 2x C02300W

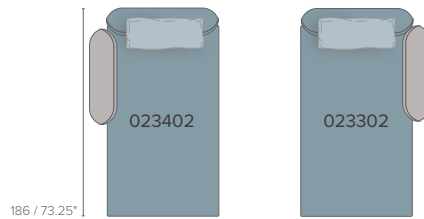

**SET 18**  
 Frame: 023402 + 023302  
 Cushions: C023402W + C023302W  
 Casual back cushions: 2x C02300W



The table tops mentioned are in teak. For lava stone there is an additional cost.  
 Los tableros mencionados son de teca. Para la piedra de lava hay un coste adicional.

- = ARM LOW  
= Brazo bajo
- = SEAT DEPTH: DEEP  
= Asiento profundo
- = TABLE  
= Mesa
- = TABLE DEEP  
= Mesa profunda

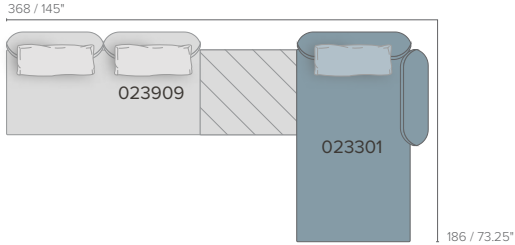

**SET 19**  
 Frame: 023909 + 023301  
 Cushions: C023909W + C023301W  
 Casual back cushions: 3x C02300W

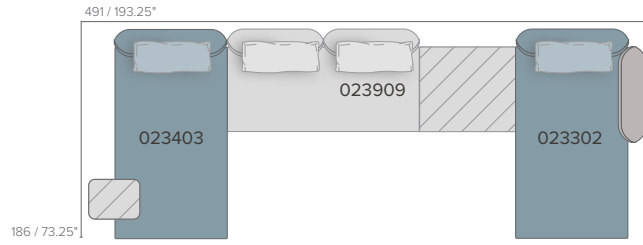

**SET 20**  
 Frame: 023403 + 023909 + 023302  
 Cushions: C023403W + C023909W + C023302W  
 Table: 02381-T  
 Casual back cushions: 4x C02300W

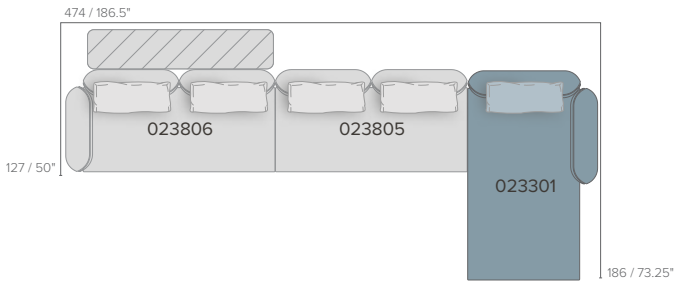

**SET 21**  
 Frame: 023806 + 023805 + 023301  
 Cushions: C023806W + C023805W + C023301W  
 Table: 02387-T  
 Casual back cushions: 5x C02300W

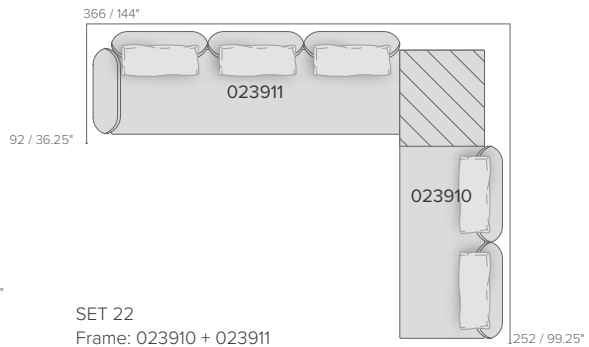

**SET 22**  
 Frame: 023910 + 023911  
 Cushions: C023910W + C023911W  
 Casual back cushions: 5x C02300W



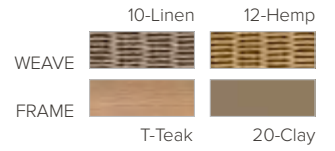

Aluminum, high pressure injected  
Aluminio inyectado a alta presión

Plantation teak from Java  
Teca de plantación de Java

Trizo Rope  
Trizo Rope

Armchair  
Silla con brazos



02718-20-12



02718-T-12



**D2718**  
Cover  
Funda

**C02718SW**  
Seat cushion  
Cojín de asiento



Lounge chair  
Sillón Lounge



02712-20-12



02712-T-12



**D2712**  
Cover  
Funda

**C02712SW**  
Seat cushion  
Cojín de asiento





Aluminum, high pressure injected  
Aluminio inyectado a alta presión

Plantation teak from Java  
Teca de plantación de Java

Trizo Rope  
Trizo Rope

## Banquette

02708-20-10

02708-20-12



02708-T-10

02708-T-12



**D2708**  
Cover  
Funda

**C02708SW**  
Seat cushion  
Cojín de asiento



## Dining table Mesa de comedor



T-Teak

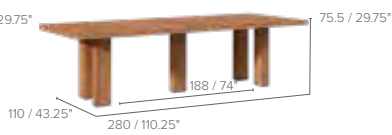
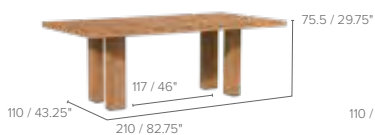

210x110cm/82.75x43.25" 02752-T  
280x110cm/110.25x43.25"  
420x110cm/165.25x43.25"  
490x110cm/193x43.25"  
560x110cm/220.5x43.25"  
630x110cm/248x43.25"

02753-T

02754-T  
02755-T  
02756-T  
02757-T



# T-TABLE DINING

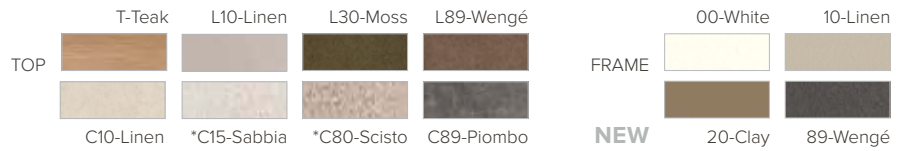

Powdercoated stainless steel  
Acero inoxidable lacado al polvo

Table top: glazed lava stone (L), ceramic (C) or teak (T)  
Tablero de mesa: piedra de lava esmaltada, cerámica o teca

\*This color may possibly show delicate veins.  
\*Este color puede mostrar pequeñas vetas

Dining table  
Mesa de comedor

	75 / 29.5"				
Ø 80cm/31.5"		D2166-00-T	D2166-10-T	D2166-20-T	D2166-89-T
Ø 90cm/35.5"		D2160-00-T	D2160-10-T	D2160-20-T	D2160-89-T
Ø 125cm/49.25"		D2162-00-T	D2162-10-T	D2162-20-T	D2162-89-T
Ø 80cm/31.5"		D2166-00-Cx	D2166-10-Cx	D2166-20-Cx	D2166-89-Cx
Ø 90cm/35.5"		D2160-00-Cx	D2160-10-Cx	D2160-20-Cx	D2160-89-Cx
Ø 125cm/49.25"		D2162-00-Cx	D2162-10-Cx	D2162-20-Cx	D2162-89-Cx
Ø 80cm/31.5"		D2166-00-Lx	D2166-10-Lx	D2166-20-Lx	D2166-89-Lx
Ø 90cm/35.5"		D2160-00-Lx	D2160-10-Lx	D2160-20-Lx	D2160-89-Lx
Ø 125cm/49.25"		D2162-00-Lx	D2162-10-Lx	D2162-20-Lx	D2162-89-Lx

Dining table  
Mesa de comedor

	76.2 / 30"				
90x90cm/ 35.5"x35.5"		D2170-00-T	D2170-10-T	D2170-20-T	D2170-89-T
90x90cm/ 35.5"x35.5"		D2170-00-Cx	D2170-10-Cx	D2170-20-Cx	D2170-89-Cx
90x90cm/ 35.5"x35.5"		D2170-00-Lx	D2170-10-Lx	D2170-20-Lx	D2170-89-Lx

Dining table  
Mesa de comedor

	75 / 29.5"				
Elipse - 53.5" x 31.5"		D2183-00-T	D2183-10-T	D2183-20-T	D2183-89-T
Elipse - 53.5" x 31.5"		D2183-00-Cx	D2183-10-Cx	D2183-20-Cx	D2183-89-Cx
Elipse - 53.5" x 31.5"		D2183-00-Lx	D2183-10-Lx	D2183-20-Lx	D2183-89-Lx

\*Dining table  
\*Mesa de comedor

	75.2 / 29.5"				
240x98cm/94.5x38.5"		D2175-00-T	D2175-10-T	D2175-20-T	D2175-89-T
298x98cm/117.25x38.5"		D2176-00-T	D2176-10-T	D2176-20-T	D2176-89-T
240x98cm/94.5x38.5"		D2175-00-Cx	D2175-10-Cx	D2175-20-Cx	D2175-89-Cx
298x98cm/117.25x38.5"		D2176-00-Cx	D2176-10-Cx	D2176-20-Cx	D2176-89-Cx

\* No Lavastone top

Note: the height and clearance under the table may differ according to the type of table top. Please consult the product sheet on our website.

Nota: la altura y el espacio libre debajo de la mesa pueden diferir según el tipo de tablero. Consulte la ficha del producto en nuestro sitio web.



# T-TABLE LOW DINING

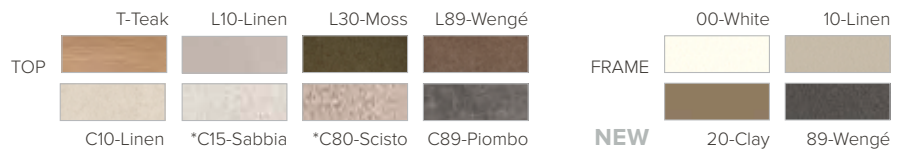

Powdercoated stainless steel  
Acero inoxidable lacado al polvo

Table top: glazed lava stone (L), ceramic (C) or teak (T)  
Tablero de mesa: piedra de lava esmaltada, cerámica o teca

\*This color may possibly show delicate veins.  
\*Este color puede mostrar pequeñas vetas

**Low dining table**  
Mesa de comedor baja

68 / 26.75"

Ø 80cm/31.5"	D2167-00-T	D2167-10-T	D2167-20-T	D2167-89-T
Ø 90cm/35.5"	D2161-00-T	D2161-10-T	D2161-20-T	D2161-89-T
Ø 125cm/49.25"	D2163-00-T	D2163-10-T	D2163-20-T	D2163-89-T
Ø 80cm/31.5"	D2167-00-Cx	D2167-10-Cx	D2167-20-Cx	D2167-89-Cx
Ø 90cm/35.5"	D2161-00-Cx	D2161-10-Cx	D2161-20-Cx	D2161-89-Cx
Ø 125cm/49.25"	D2163-00-Cx	D2163-10-Cx	D2163-20-Cx	D2163-89-Cx
Ø 80cm/31.5"	D2167-00-Lx	D2167-10-Lx	D2167-20-Lx	D2167-89-Lx
Ø 90cm/35.5"	D2161-00-Lx	D2161-10-Lx	D2161-20-Lx	D2161-89-Lx
Ø 125cm/49.25"	D2163-00-Lx	D2163-10-Lx	D2163-20-Lx	D2163-89-Lx

**Low dining table**  
Mesa de comedor baja

68.2 / 26.75"

90x90cm/ 35.5"x35.5"	D2172-00-T	D2172-10-T	D2172-20-T	D2172-89-T
90x90cm/ 35.5"x35.5"	D2172-00-Cx	D2172-10-Cx	D2172-20-Cx	D2172-89-Cx
90x90cm/ 35.5"x35.5"	D2172-00-Lx	D2172-10-Lx	D2172-20-Lx	D2172-89-Lx

**Low dining table**  
Mesa de comedor baja

68 / 26.75"

Elipse - 53.5" x 31.5"	D2184-00-T	D2184-10-T	D2184-20-T	D2184-89-T
Elipse - 53.5" x 31.5"	D2184-00-Cx	D2184-10-Cx	D2184-20-Cx	D2184-89-Cx
Elipse - 53.5" x 31.5"	D2184-00-Lx	D2184-10-Lx	D2184-20-Lx	D2184-89-Lx

**\*Low dining table**  
\*Mesa de comedor baja

67.2 / 26.5"

240x98cm/94.5x38.5"	D2177-00-T	D2177-10-T	D2177-20-T	D2177-89-T
298x98cm/117.25x38.5"	D2178-00-T	D2178-10-T	D2178-20-T	D2178-89-T
240x98cm/94.5x38.5"	D2177-00-Cx	D2177-10-Cx	D2177-20-Cx	D2177-89-Cx
298x98cm/117.25x38.5"	D2178-00-Cx	D2178-10-Cx	D2178-20-Cx	D2178-89-Cx

\* No Lavastone top

Note: the height and clearance under the table may differ according to the type of table top. Please consult the product sheet on our website.

Nota: la altura y el espacio libre debajo de la mesa pueden diferir según el tipo de tablero. Consulte la ficha del producto en nuestro sitio web.



# T-TABLE COFFEE

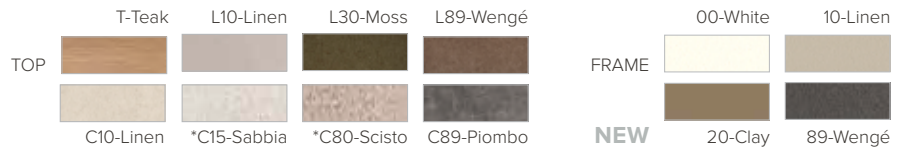

Powdercoated stainless steel  
Acero inoxidable lacado al polvo

Table top: glazed lava stone (L), ceramic (C) or teak (T)  
Tablero de mesa: piedra de lava esmaltada, cerámica o teca

\*This color may possibly show delicate veins.  
\*Este color puede mostrar pequeñas vetas

Coffee table  
Mesa auxiliar

35 / 13,75"



Ø 80cm/31,5"  
Ø 90cm/35,5"  
Ø 125cm/49,25"

D2168-00-T  
D2164-00-T  
D2165-00-T

D2168-10-T  
D2164-10-T  
D2165-10-T

D2168-20-T  
D2164-20-T  
D2165-20-T

D2168-89-T  
D2164-89-T  
D2165-89-T

Ø 80cm/31,5"  
Ø 90cm/35,5"  
Ø 125cm/49,25"

D2168-00-Cx  
D2164-00-Cx  
D2165-00-Cx

D2168-10-Cx  
D2164-10-Cx  
D2165-10-Cx

D2168-20-Cx  
D2164-20-Cx  
D2165-20-Cx

D2168-89-Cx  
D2164-89-Cx  
D2165-89-Cx

Ø 80cm/31,5"  
Ø 90cm/35,5"  
Ø 125cm/49,25"

D2168-00-Lx  
D2164-00-Lx  
D2165-00-Lx

D2168-10-Lx  
D2164-10-Lx  
D2165-10-Lx

D2168-20-Lx  
D2164-20-Lx  
D2165-20-Lx

D2168-89-Lx  
D2164-89-Lx  
D2165-89-Lx

Coffee table  
Mesa auxiliar

35 / 13,75"



90x90cm/ 35.5"x35.5" D2174-00-T  
90x90cm/ 35.5"x35.5" D2174-00-Cx  
90x90cm/ 35.5"x35.5" D2174-00-Lx

D2174-10-T  
D2174-10-Cx  
D2174-10-Lx

D2174-20-T  
D2174-20-Cx  
D2174-20-Lx

D2174-89-T  
D2174-89-Cx  
D2174-89-Lx

Coffee table  
Mesa auxiliar

35 / 13,75"



Elipse - 53.5" x 31.5"  
Elipse - 53.5" x 31.5"  
Elipse - 53.5" x 31.5"

D2185-00-T  
D2185-00-Cx  
D2185-00-Lx

D2185-10-T  
D2185-10-Cx  
D2185-10-Lx

D2185-20-T  
D2185-20-Cx  
D2185-20-Lx

D2185-89-T  
D2185-89-Cx  
D2185-89-Lx

\*Coffee table  
\*Mesa auxiliar

35 / 13,75"



240x98cm/94.5x38.5" D2179-00-T  
298x98cm/117.25x38.5" D2180-00-T

D2179-10-T  
D2180-10-T

D2179-20-T  
D2180-20-T

D2179-89-T  
D2180-89-T

240x98cm/94.5x38.5" D2179-00-Cx  
298x98cm/117.25x38.5" D2180-00-Cx

D2179-10-Cx  
D2180-10-Cx

D2179-20-Cx  
D2180-20-Cx

D2179-89-Cx  
D2180-89-Cx

\* No Lavastone top

Note: the height and clearance under the table may differ according to the type of table top. Please consult the product sheet on our website.

Nota: la altura y el espacio libre debajo de la mesa pueden diferir según el tipo de tablero. Consulte la ficha del producto en nuestro sitio web.



# TAO TABLE

MONICA ARMANI

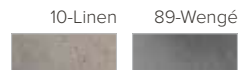

Lightened concrete  
Hormigón aligerado

This material is sensitive to stains  
Este material es sensible a las manchas

*🔧* Dining Table  
Mesa de comedor



Ø 160cm/63"      01666-10  
Ø 180cm/71"      01668-10

01666-89  
01668-89

*🔧* Dining Table  
Mesa de comedor

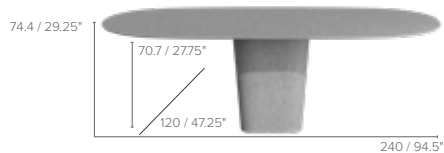

Oval      01670-10

01670-89

Weight filling bag included  
Bolsa de relleno de peso incluida



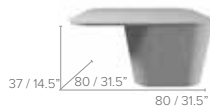

*🔧* Coffee Table  
Mesita de salón



01682-10

01682-89



	10-Linen	89-Wengé
WEAVE		
FRAME		
	10-Linen	89-Wengé

Powdercoated stainless steel  
Acero inoxidable lacado al polvo

Braiding: foam in a knitted sheath of Tricord® (polyofin) and textile  
Trenzado: espuma en una malla tejida de Tricord® (poliolefina) y textileno

Seat support: Batyline  
Asiento en Batyline

Armchair  
Silla con brazos

05318-10

05318-89



**D5318**  
Cover  
Funda

**C05318BW**  
Back cushion  
Cojín de respaldo

**C05318SW**  
Seat cushion  
Cojín de asiento



Counter height chair  
Taburete altura del mostrador

05315-10

05315-89



**D5315**  
Cover  
Funda

**C05318BW**  
Back cushion  
Cojín de respaldo

**C05315SW**  
Seat cushion  
Cojín de asiento





Powdercoated stainless steel  
Acero inoxidable lacado al polvo

Braiding: foam in a knitted sheath of Tricord® (polyofin) and textilene  
Trenzado: espuma en una malla tejida de Tricord® (poliolefina) y textileno

Seat support: Batyline  
Asiento en Batyline

Low dining chair  
Sillón bajo

05317-10

05317-89



**D5317**  
Cover  
Funda

**C05317BW**  
Back cushion  
Cojín de respaldo

**C05317SW**  
Seat cushion  
Cojín de asiento



Lounge chair  
Sillón Lounge

05302-10

05302-89



**D5302**  
Cover  
Funda

**C05302BW**  
Back cushion  
Cojín de respaldo





**C05302SW**  
Seat cushion  
Cojín de asiento



**C0013W**  
Option lumbar cushion  
Opción cojín lumbar





	10-Linen	89-Wengé
WEAVE		
FRAME		
	10-Linen	89-Wengé

Powdercoated stainless steel  
Acero inoxidable lacado al polvo

Braiding: foam in a knitted sleeve of Tricord® (polyofin) and textile  
Trenzado: espuma en una malla tejida de Tricord® (poliolefina) y textileno

Seat support: Batyline  
Asiento en Batyline

2-Seater sofa  
Sofá 2 plazas

05308-10

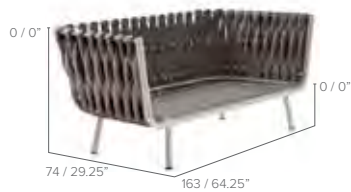

05308-89



**D5308**  
Cover  
Funda

**C05308BW**  
Back cushion  
Cojín de respaldo

(order 2x!)

**C05308SW**  
Seat cushion  
Cojín de asiento



**C0013W**  
Option lumbar cushion  
Opción cojín lumbar



3-Seater sofa  
Sofá 3 plazas

05309-10



05309-89



**D5309**  
Cover  
Funda

**C05309BW**  
Back cushion  
Cojín de respaldo

(order 3x!)

**C05309SW**  
Seat cushion  
Cojín de asiento



**C0013W**  
Option lumbar cushion  
Opción cojín lumbar





Powdercoated stainless steel  
Acero inoxidable lacado al polvo

Braiding: foam in a knitted sleeve of Tricord® (polyofin) and textile  
Trenzado: espuma en una malla tejida de Tricord® (poliolefina) y textileno

Seat support: Batyline  
Asiento en Batyline

Adjustable lounger  
Tumbona reclinable

05340-10

05340-89



**D5340**  
Cover  
Funda

**C05340W**  
Cushion  
Cojín



Daybed  
Daybed

05349-10

05349-89



**D5349**  
Cover  
Funda

**C05349BW**  
Back cushion  
Cojín de respaldo

70x60cm, order 3x!

**C05349SW**  
Seat cushion  
Cojín de asiento



For optimal comfort, we recommend completing the Daybed with 3 backs and several deco cushions. (p. 101)

Para una sensación acogedora, recomendamos completar el Daybed con 3 cojines de respaldo y diferentes almohadones deco. (pag. 101)



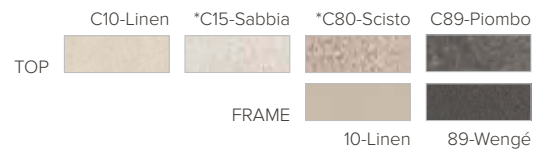

Powdercoated stainless steel  
Acero inoxidable lacado al polvo

Table top: ceramic  
Tablero de mesa: cerámica

\*This color may possibly show delicate veins.  
\*Este color puede mostrar pequeñas vetas

Dining table  
Mesa de comedor



240cm/94.5"  
298cm/117.25"

05355-10-xx  
05354-10-xx

05355-89-xx  
05354-89-xx

Low Dining table  
Mesa de comedor baja



240cm/94.5"  
298cm/117.25"

05335-10-xx  
05334-10-xx

05335-89-xx  
05334-89-xx

Side table  
Mesa auxiliar



05381-10-xx

05381-89-xx

Coffee Table  
Mesa auxiliar



05386-10-xx

05386-89-xx





Plantation teak from Java  
Teca de plantación de Java

 Armchair  
Silla con brazos



**D7518**  
Cover  
Funda

**C07518W**  
Seat & Back Cushion  
Cojín de asiento y respaldo

**C07518SW**  
Seat cushion  
Cojín de asiento



 Lounge chair  
Sillón Lounge



**D7512**  
Cover  
Funda

**C07512BW**  
Back cushion  
Cojín de respaldo

**C07512SW**  
Seat cushion  
Cojín de asiento



 Adjustable lounger  
Tumbona reclinable

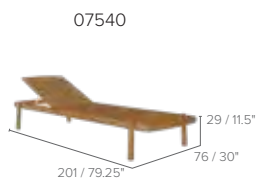

**D7540**  
Cover  
Funda

**\*C07540W**  
Cushion  
Cojín

**C0005W**  
Head support lounger for Ukiyo  
Reposa-cabeza tumbona Ukiyo

\*Head support not included





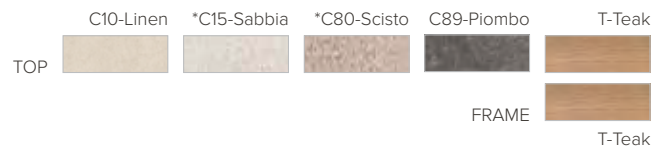

Plantation teak from Java  
Teca de plantación de Java

Table top: ceramic  
Tablero de mesa: cerámica

\*This color may possibly show delicate veins.  
\*Este color puede mostrar pequeñas vetas

Dining table  
Mesa de comedor



07553-xx

Coffee Table  
Mesa auxiliar



07586-xx

Low table  
Mesa auxiliar



07588-xx



Plantation teak from Java  
 Teca de plantación de Java

Plaited straps in Canax®  
 Cintas trenzadas en Canax®

Armchair  
 Silla con brazos

01718



**D1718**  
 Cover  
 Funda

**C01718BW**  
 Lumbar cushion  
 Lumbar Cojín

**C01718SW**  
 Seat cushion  
 Cojín de asiento



Lounge chair  
 Sillón Lounge

01712



**D1712**  
 Cover  
 Funda

**C01712BW**  
 Lumbar cushion  
 Lumbar Cojín

**C01712SW**  
 Seat cushion  
 Cojín de asiento







Plantation teak from Java  
Teca de plantación de Java

Plaited straps in Canax®  
Cintas trenzadas en Canax®

Rocking chair  
Mecedora

01713



**D1713**  
Cover  
Funda

**C01713BW**  
Lumbar cushion  
Lumbar Cojín

**C01713SW**  
Seat cushion  
Cojín de asiento



Bench  
Banco

01734



H44cm

**D1734**  
Cover  
Funda

**C01734W**  
Cushion  
Cojín





# VIS À VIS

PIERGIORGIO CAZZANIGA

Plantation teak from Java  
Teca de plantación de Java

 Lounger, adjustable  
Tumbona, reclinable



01740  
01740W\*\*\*

\*\*\*Set of wheels \*\*\*Conjunto de ruedas

**D6130**  
Cover  
Funda

**C01740W**  
Cushion  
Cojín

**C01741W**  
Project cushion\*  
Cojín de proyecto\*



\* 2 compartment cushion without headrest.  
\* Almohada de 2 piezas sin reposacabezas.

 Lounger, adjustable, wheels  
Tumbona, reclinable, ruedas

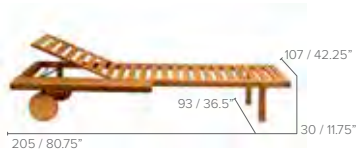

01741

**D6130**  
Cover  
Funda

**C01740W**  
Cushion  
Cojín

**C01741W**  
Project cushion\*  
Cojín de proyecto\*



\* 2 compartment cushion without headrest.  
\* Almohada de 2 piezas sin reposacabezas.

 Dining table  
Mesa de comedor



01773



01753  
01754  
01755  
01756  
01757

99cm/39"  
300cm/118"  
400cm/157.5"  
500cm/197" \*\*  
600cm/236.25" \*\*  
700cm/275.5" \*\*

\*\* From a length of 197" or more, a third set of legs is added.  
\*\* A partir de una longitud de 5 metros, se añadirá un tercer juego de patas.



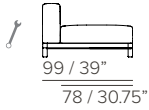

Plantation teak from Java  
Teca de plantación de Java

Brackets for cushions in stainless steel  
Soporte para los cojines en acero inoxidable

Casual back cushions **not included\***  
Cojín de respaldo casual **no incluido\***

Pouf module

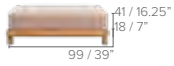

Frame 01792

Cushion C01792W

Cover D1792

Extension module single



01700

C01700W

D1700

Corner module right arm

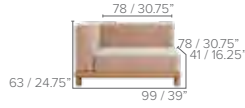

01701R

C01701W

D1731R

Corner module left arm



01701L

C01701W

D1731L

Center module



Frame 01708

Cushion C01708W

Cover D1732

Extension pouf left

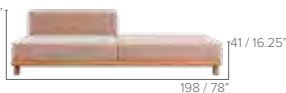

01706L

C01706W

D1730L

Extension pouf right



01706R

C01706W

D1730R

Extension module double



01728

C01728W

D1728

Right arm module



Frame 01738R

Cushion C01738W

Cover D1738R

Left arm module



01738L

C01738W

D1738L

2-Seater sofa



01709

C01709W

D1733

Meridienne right short arm



Frame 01704S

Cushion C01704SW

Cover D1704S

Meridienne left short arm



01703S

C01703SW

D1703S

Meridienne right long arm



01704

C01704W

D1720R

Meridienne left long arm



01703

C01703W

D1720L

Daybed module



01742

C01742W

D1742



# VIS À VIS SOFA

PIERGIORGIO CAZZANIGA

T-Teak



Plantation teak from Java  
Teca de plantación de Java

Casual back cushion  
Cojín de respaldo Casual  
63x45x15cm  
24.75x17.75x6"

C0012W

To order separately!  
Hacer pedido por separado!



Cat D  
Cat E  
Cat F

High backrest cushion\*  
Cojín de respaldo alto\*  
76x60x15cm  
30x23.5x6"

C0012BHW

To order separately!  
Hacer pedido por separado!

\*Support bracket in stainless steel with cover in fabric included.  
\*Soporte de acero inoxidable con cubierta de tela incluido.



Cat D  
Cat E  
Cat F



Coffee table  
Mesa auxiliar



Cover  
Funda

99x99cm/39x39"  
121x99cm/47.75x39"  
121x121cm/47.75x47.75"  
159x44cm/62.5x17.25"

01781  
01784  
01786

01732

D1781  
D1784  
D1786  
D1735



Options borders H 18cm - 7.08"  
Tarima opcional H 18cm

01700B

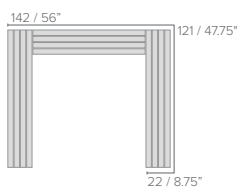

01701B

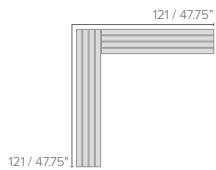

01704B

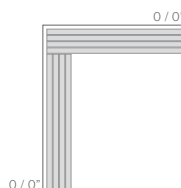

01706B



01709B

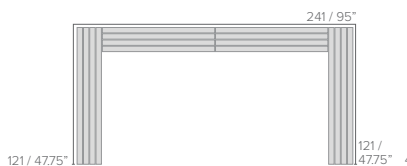

01738B

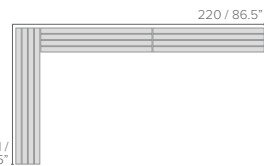

01796B

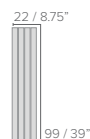

01797B

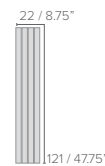





Custom covers = \$255 per single seat and \$515 for meridienne and daybed modules.

Fundas a medida = \$255 por asiento individual y \$515 para módulos meridienne y daybed.

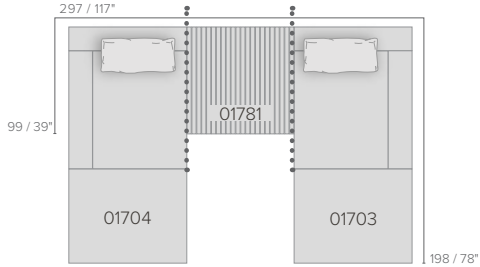

#### SET 1b

frame: 01704 + 01703 + 01781  
cushions: C01704W + C01703W  
back cushions: 2x C0012W

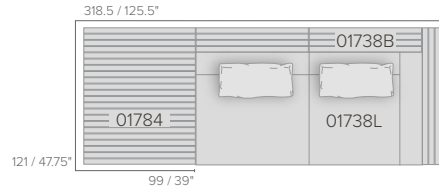

#### SET 2

frame: 01738L + 01738B + 01784  
cushions: C01738W  
back cushions: 2x C0012W

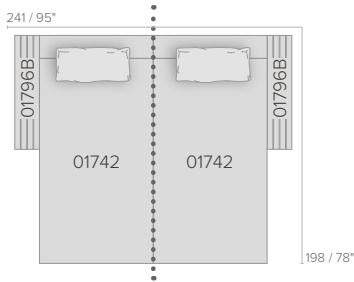

#### SET 3b

frame: 2x 01742 + 2x 01796B  
cushions: 2x C01742W  
back cushions: 2x C0012W

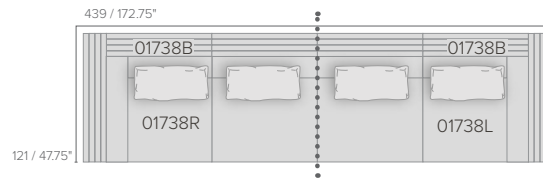

#### SET 4

frame: 01738R + 01738L + 2x 01738B  
cushions: 2x C01738W  
back cushions: 4x C0012W

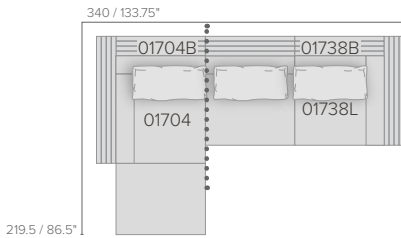

#### SET 5

frame: 01704 + 01738L + 01738B + 01704B  
cushions: C01704W + C01738W  
back cushions: 3x C0012W

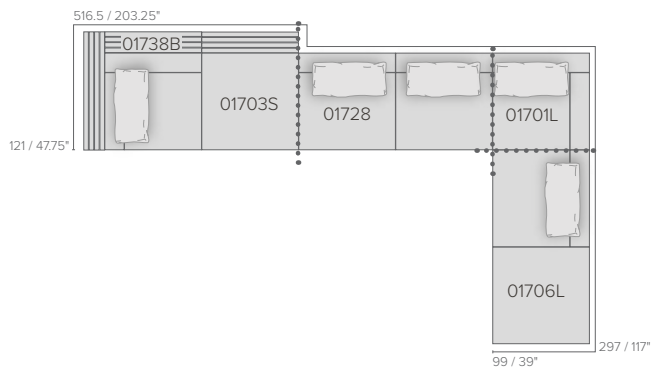

#### SET 6b

frame: 01703S + 01728 + 01701L + 01706L + 01738B  
cushions: C01703SW + C01728W + C01701W + C01706W  
back cushions: 5x C0012W



# VIS À VIS SOFA SETS

PIERGIORGIO CAZZANIGA

Covers cover only the cushions, not the borders or tables. In case you order a high back cushion, please indicate the position on your set.  
Las fundas solo cubren los cojines, no los bordes o las mesas. Si usted ordena un cojín de respaldo alto, por favor indique su posición en su juego.

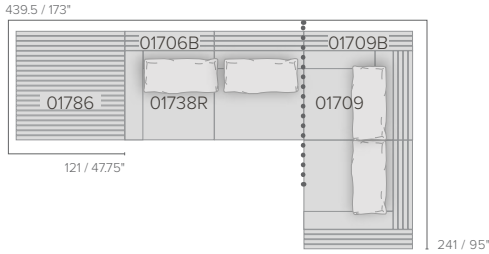

## SET 7

frame: 01738R + 01709 + 01786 + 01706B + 01709B  
cushions: C01738W + C01709W  
back cushions: 4x C0012W

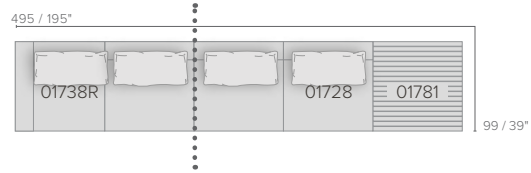

## SET 8

frame: 01738R + 01728 + 01781  
cushions: C01738W + C01728W  
back cushions: 4x C0012W

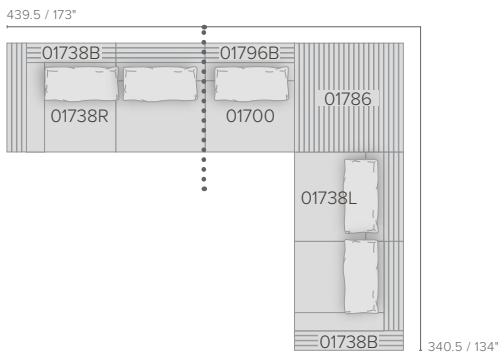

## SET 9

frame: 01738R + 01700 + 01786 + 01738L + 2x 01738B + 01796B  
cushions: 2x C01738W + C01700W  
back cushions: 5x C0012W

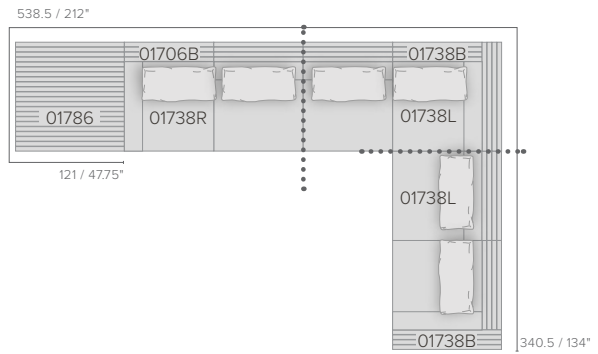

## SET 10

frame: 01738R + 2x 01738L + 01786 + 01706B + 2x 01738B  
cushions: 3x C01738W  
back cushions: 6x C0012W

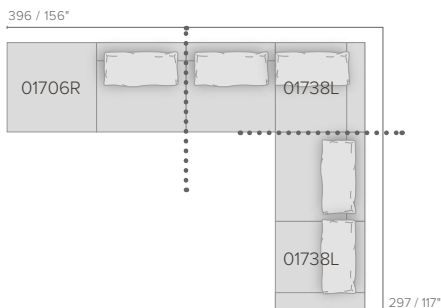

## SET 11

frame: 01706R + 2x 01738L  
cushions: 2x C01738W + C01706W  
back cushions: 5x C0012W

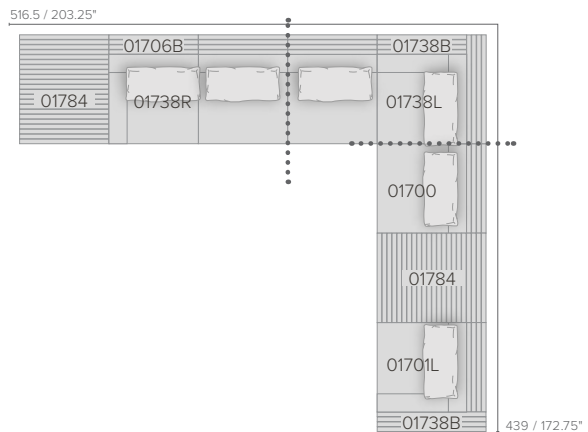

## SET 12

frame: 01738R + 01738L + 01700 + 01701L + 01706B + 2x 01738B + 2x 01784  
cushions: 2x C01738W + C01700W + C01701W  
back cushions: 6x C0012W





Covers cover only the cushions, not the borders or tables. In case you order a high back cushion, please indicate the position on your set.  
Las fundas solo cubren los cojines, no los bordes o las mesas. Si usted ordena un cojín de respaldo alto, por favor indique su posición en su juego.

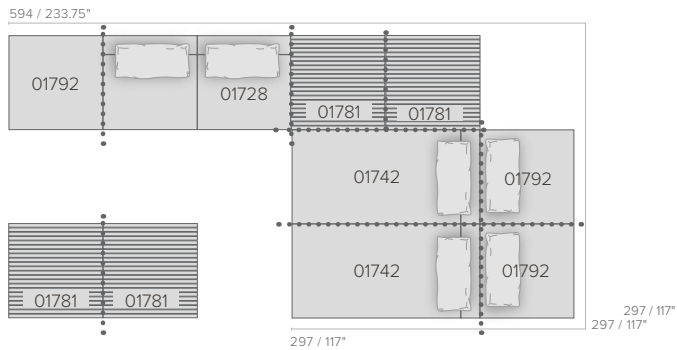

SET 13

frame: 3x 01792 + 01728 + 2x 01742 + 4x 01781  
cushions: 3x C01792W + C01728W + 2x C01742W  
back cushions: 6x C0012W

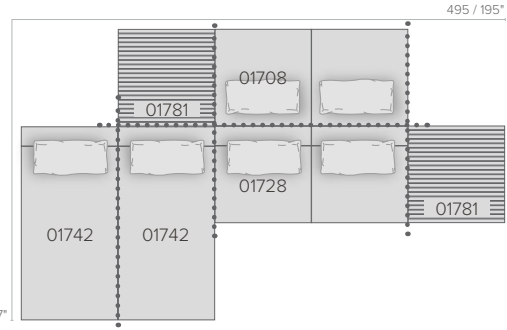

SET 14

frame: 2x 01742 + 01728 + 01708 + 2x 01781  
cushions: 2x C01742W + C01728W + C01708W  
back cushions: 6x C0012W

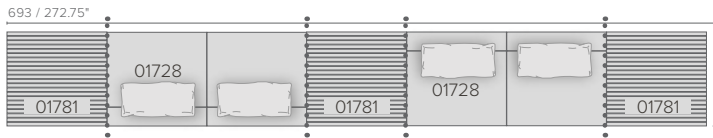

SET 15

frame: 2x 01728 + 3x 01781  
cushions: 2x C01728W  
back cushions: 4x C0012W

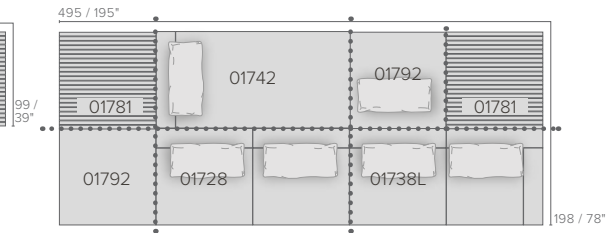

SET 16

frame: 01742 + 2x 01792 + 01728 + 01738L + 2x 01781  
cushions: C01742W + 2x C01792W + C01728W + C01738W  
back cushions: 6x C0012W

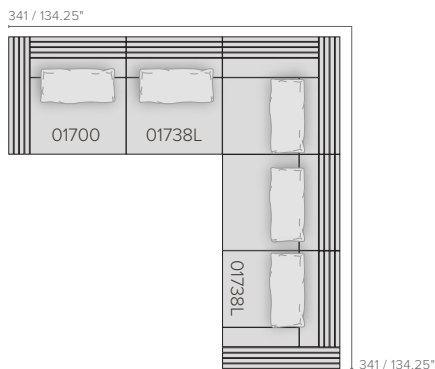

SET 17

frame: 2x 01738L + 01700 + 01701B + 2x 01738B  
cushions: 2x C01738W + C01700W  
back cushions: 5x C0012W

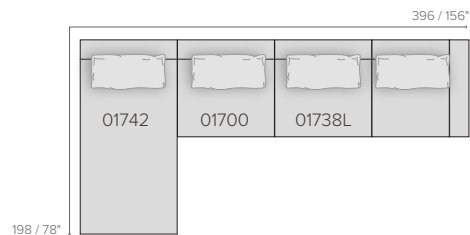

SET 18

frame: 01742 + 01700 + 01738L  
cushions: C01742 + C01700W + C01738W  
back cushions: 4x C0012W



# UMBRELLAS

## PARASOLES

 = solution-dyed / teñido en masa

Powdercoated aluminum  
Aluminio lacado al polvo

Base not included  
Pie no incluido

FRAME



FABRIC



Eclipse (round)  
Eclipse (redondo)



UA315-00-01



UA315-10-64



UA315-89-89

Cover  
Funda

dia 350cm/137.75"  
Canopy Ø 61 mm / Ø 2.4"

D6003-X

Eclipse (square)  
Eclipse (cuadrado)



UA322-00-01  
UA323-00-01



UA322-10-64  
UA323-10-64



UA322-89-89  
UA323-89-89

Cover  
Funda

300x300cm/118x118"  
350x350cm/137.75x137.75"  
Canopy Ø 61 mm / Ø 2.4"

D6003-X  
D6004-X

Eucalyptus wood  
Madera de Eucalipto

Base not included  
Pie no incluido

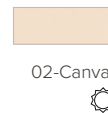

Eclipse (round)  
Eclipse (redondo)



UW315-02



UW315-72

Cover  
Funda

dia 350cm/137.75"  
Canopy Ø 63 mm / Ø 2.5"

D6003-X

Eclipse (square)  
Eclipse (cuadrado)



UW322-02  
UW323-02



UW322-72  
UW323-72

Cover  
Funda

300x300cm/118x118"  
350x350cm/137.75x137.75"  
Canopy Ø 63 mm / Ø 2.5"

D6003-X  
D6004-X



Granite base  
Base de granito

BG32

58 / 22.75"

6 / 2.25"

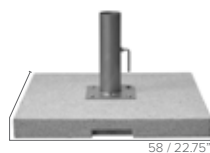

56 kg  
123.5lbs







# LOW TABLES

## MESA AUXILIAR

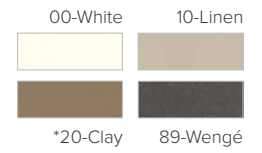

Powdercoated aluminum  
 Aluminio lacado al polvo

\* Only for Natal Alu X

Drops

D5026-00  
 40 / 15.75"



D5026-10



D5026-89



Dia 40cm/15.75"

Drops

D5027-00  
 60 / 23.5"



D5027-10



D5027-89



Dia 60cm/23.5"

Each package contains 3 tubes of 11.75, 15.75 and 19.75" heights. One of the 3 can be assembled as table leg, according to your liking.  
 Cada paquete contiene 3 tubos con una altura de 30, 40 y 50cm. Se puede montar uno de los tres tubos segun la altura deseada.

Natal Alu X high round  
 Mesa auxiliar alta redonda



Natal Alu X low 15.75"  
 Natal Alu X baja 40x40cm

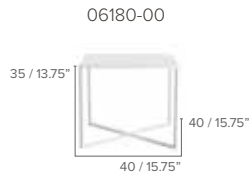

Natal Alu X low 23.5"  
 Natal Alu X baja 60x60cm

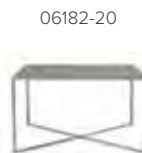
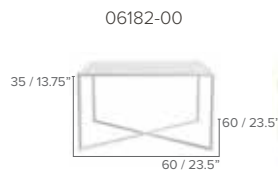



Plantation teak from Java  
Teca de plantación de Java

 Dunes Side table  
Dunes Mesa auxiliar



Teak  
Terrazzo

**D8300-TZ**



**NEW**

 Dunes Coffee table  
Dunes Mesita de salón



Teak  
Terrazzo

**D8302-TZ**



**NEW**

 Dunes Low Dining table  
Dunes mesa de comedor baja



Limited availability

Roots



The Dunes and Roots collections are defined by the elegant pattern of the wood grain. Chiseled out of Tribù's plantation-grown teak, every detail, every knot, every crack is proudly on display.

Las líneas Dunes y Roots se definen por la elegancia de sus vetas. Son elaboradas con teca cultivada en plantaciones de Tribù y cada detalle, cada nudo, cada grieta, se desgastan con orgullo.





# LOW TABLES

## MESA AUXILIAR

The teak base is not made of solid teak  
La base de teca no es maciza.

Tairu

D8103-Lx



Lavastone

Lx-Table top: glazed lava stone  
Lx-Tablero de mesa: piedra de lava esmaltada



L10-Linen

L30-Moss



L60-Burgundy

L89-Wengé

Hexagon

Coffee Table  
Mesita auxiliar baja



Lavastone

D5040-Lx

Side Table  
Mesita auxiliar alta



Lavastone

D5041-Lx

Otto

Dia 19" - H12.6"



Ceramic  
Teak  
Travertine

04281-Cx  
04281-T  
04281-TV

Dia 23.5" - H12.6"

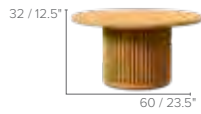

Ceramic  
Teak  
Travertine

04283-Cx  
04283-T  
04283-TV

Dia 35.5" - H12.6"



Ceramic  
Teak  
Travertine

04284-Cx  
04284-T  
04284-TV

Table top: ceramic, travertine or teak  
Tablero de mesa: cerámica, travertino o teca

\*C15-Sabbia \*C80-Scisto



NEW



\*\*TV-Travertine

T-Teak

Dia 19" - H21.5"



Ceramic  
Teak  
Travertine

04280-Cx  
04280-T  
04280-TV

Dia 23.5" - H21.5"



Ceramic  
Teak  
Travertine

04282-Cx  
04282-T  
04282-TV

\* This color may possibly show delicate veins - Este color puede mostrar pequeñas vetas

\*\* This material is sensitive to stains - Este material es sensible a las manchas

C-table  
Mesita C

01285



Teak

Covers see p.111  
Funda consulte p.111



ACCESORIOS

Lanterns  
Faroles

Lantern low  
Farol bajo

Lantern high  
Farol alto

Lantern support  
Farol pedestal

Teak frame



D5015



D5016



D5017



Chemically tempered glass  
Vidrio endurecido químicamente

Luna



D09010-89

Adapter

EAD002 For US - UL

Powdercoated Aluminum  
89-Wengé



Please notice that the adapter for the Luna lamp must be ordered separately.

Handblown glass  
Vidrio soplado a mano

Gobi

Small  
Pequeña

Large  
Grande



D3020-x



D3010-x

Recycled Acrylic



10-Linen

30-Moss

This is a seasonal product. We recommend not leaving the product outside in the rain. A cover is not available.  
Este es un producto de temporada. No recomendamos dejar este producto al aire libre bajo la lluvia. El cover no está disponible.



# LOFT RUGS

## ALFOMBRAS PARA EL EXTERIOR

PVC coated polyester  
Poliéster recubierto de PVC

On order - 8-10 weeks  
según pedido - 8-10 semanas

Rug Loft  
Alfombra Loft

D2001-x



- 200x200cm/78.75x78.75\*\*\*
- 200x240cm/78.75x94.5\*\*\*
- 200x300cm/78.75x118.25\*\*\*
- 250x250cm/98.5x98.5\*\*\*
- 250x300cm/98.5x118.25\*\*\*
- 250x350cm/98.5x137.75\*\*\*



# SHINDI RUGS

## ALFOMBRAS PARA EL EXTERIOR

PVC coated polyester  
Poliéster recubierto de PVC

3D weaving  
Tejido 3D

Rug Shindi  
Alfombra Shindi

D2003-x



- 200x200cm/78.75x78.75\*\*\*
- 200x250cm/78.75x98.5\*\*\*
- 200x300cm/78.75x118.25\*\*
- 200x350cm/78.75x137.75\*\*\*
- 250x450cm/98.5x177.25\*\*\*
- 300x300cm/118.25x118.25\*\*
- 300x400cm/118.25x157.5\*\*



# CUSTOMIZED RUGS

## ALFOMBRAS A MEDIDA

Loft  
Shindi

Maximum width 16Ft, unlimited length  
Anchura máxima 5m, longitud ilimitada



# MONSIEUR TRICOT HANGING

DESIGN STUDIO MAISON TRICOT

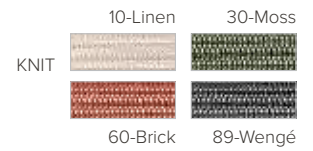

Removable knit in polyolefin rope.  
Tejido de punto removible en cuerda de poliolefina.

LED lamp.  
Lámpara LED

## Monsieur Lebonnet



Hanging 30cm/11.75"  
Hanging 40cm/15.75"  
Hanging 60cm/23.5"

D080130H-xx

D080140H-xx

D080160H-xx

## Madame Latoque



Hanging 30cm/11.75"  
Hanging 40cm/15.75"

D080230H-xx

D080240H-xx

## Madame Cachet



Hanging 30cm/11.75"  
Hanging 40cm/15.75"  
Hanging 50cm/19.75"

D080330H-xx

D080340H-xx

D080350H-xx

## Monsieur Ellipse



Hanging 40cm/15.75"

D080440H-xx

Removable knit in polyolefin rope.  
Tejido de punto removible en cuerda de poliolefina.

PR80130-x Knit Monsieur Lebonnet 30cm/11.75"  
PR80140-x Knit Monsieur Lebonnet 30cm/11.75"  
PR80160-x Knit Monsieur Lebonnet 60cm/23.5"

PR80230-x Knit Madame Latoque 30cm/11.75"  
PR80240-x Knit Madame Latoque 40cm/15.75"

PR80330-x Knit Madame Cachet 30cm/11.75"  
PR80340-x Knit Madame Cachet 40cm/15.75"  
PR80350-x Knit Madame Cachet 50cm/19.75"

PR80440-x Knit Monsieur Ellipse 40cm/15.75"



# MONSIEUR TRICOT STANDING

DESIGN STUDIO MAISON TRICOT

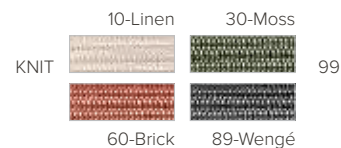

99

Removable knit in polyolefin rope. LED lamp. On/Off switch Rechargeable battery with USB slot. Tribù app Ceiling hook included  
 Tejido removible en cuerda de poliolefina. Lámpara LED Interruptor On/Off Batería recargable con puerto para USB. Aplicación Tribù Gancho de techo incluido



Monsieur Lebonnet  
 Excluded adapter



Standing 30cm/11.75"  
 Standing 40cm/15.75"  
 Standing 60cm/23.5"

D080130S-xx

D080140S-xx

D080160S-xx

Madame Latoque  
 Excluded adapter



Standing 30cm/11.75"  
 Standing 40cm/15.75"

D080230S-xx

D080240S-xx

Madame Cachet  
 Excluded adapter



Standing 30cm/11.75"  
 Standing 40cm/15.75"  
 Standing 50cm/19.75"

D080330S-xx

D080340S-xx

D080350S-xx

Removable knit in polyolefin rope.  
 Tejido de punto removible en cuerda de poliolefina.

PR80130-x	Knit Monsieur Lebonnet 30cm/11.75"
PR80140-x	Knit Monsieur Lebonnet 30cm/11.75"
PR80160-x	Knit Monsieur Lebonnet 60cm/23.5"
PR80230-x	Knit Madame Latoque 30cm/11.75"
PR80240-x	Knit Madame Latoque 40cm/15.75"
PR80330-x	Knit Madame Cachet 30cm/11.75"
PR80340-x	Knit Madame Cachet 40cm/15.75"
PR80350-x	Knit Madame Cachet 50cm/19.75"
PR80440-x	Knit Monsieur Ellipse 40cm/15.75"

Adapter

EAD002 For US - UL

Please notice that the adapter for the Monsieur Tricot lamps must be ordered separately.



**PUFS**

Production time: 6-8 weeks  
 Tiempo de entrega: 6-8 semanas



Cover **D6021**  
 Funda

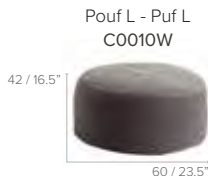

Cover **D6022**  
 Funda



Cover **D6023**  
 Funda

**NOMAD POUFS**

**NOMAD PUFs**

Production time: 12-14 weeks  
 Tiempo de entrega: 12-14 semanas



Cover **D5032**  
 Funda



Cover **D5033**  
 Funda



Cover **D5034**  
 Funda

**MAI POUFS** MAI PUFs

New Collection 2024



12-Hemp

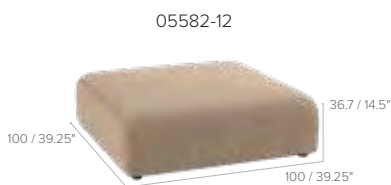

Cover **D5582**  
 Funda



Cover **D5584**  
 Funda



# DECO CUSHIONS

COJINES DE DECORACIÓN



Throw cushions  
Cojines de decoración



Throw cushions with piping  
Cojines de decoración con ribete



Box cushions  
Cojines de decoración con bordes anchos

	ART. NR.	DIMENSIONS	COLLECTION
SCATTER CUSHIONS COJINES DE DECORACIÓN	C0001-x	40x40cm/15.75x15.75"	
	C0002-x	50x50cm/19.75x19.75"	
	C0003-x	60x60cm/23.5x23.5"	
	C0013-x	50x30cm/19.75x11.75"	Tosca
	C01712B-x	49x30cm/19.25x11.75"	Vis à Vis lounge chair
	C01713B-x	42,5x31,5cm/16.73x12.40"	Vis à Vis rocking chair
	C01718B-x	56x43cm/22x17"	Vis à Vis armchair
DECO + PIPING	C0001P-x-y	40x40cm/15.75x15.75"	
	C0002P-x-y	50x50cm/19.75x19.75"	
	C0003P-x-y	60x60cm/23.5x23.5"	
	C0013P-x-y	50x30cm/19.75x11.75"	Tosca
	C01712BP-x-y	49x30cm/19.25x11.75"	Vis à Vis lounge chair
	C01713BP-x-y	41,5x30cm/16.5x11.75"	Vis à Vis rocking chair
	C01718BP-x-y	56x43cm/22x17"	Vis à Vis armchair
BOX CUSHIONS COJINES	C0004-x	55x35xH8cm/21.75x13.75x3.25"	
	C0012-x	63x45x15cm/24.75x17.75x6"	Vis à Vis sofa
	C06218B-x	38x24x13cm/15x9.5x5"	Mood lumbar
	C06218BH-x	38x38x13cm/15x15x5"	Mood high back
	C02300-x	68x45x15cm/26.75x17.75x6"	Senja casual back

x = Color of the fabric determines the price category.  
Color de la tela, determina el precio

y = Piping color, only available in the following colors:  
Color del ribete, disponible en las telas siguientes

## y - Piping - Rebete

08 Natté Carbon Sky  
11 Blush  
42 Leaf  
45 Natté Mist

47 Natté Ochre  
76 Granite  
B12 Linen  
B41 Dalsace Canvas

B111 Canvas Tweed Brown  
B114 Canvas Merlot Red  
B118 Canvas Lace  
B120 Canvas Seasalt

B183 Tagika Terracotta  
B185 Tagika Eucalyptus  
B189 Tagika Moss

Head support lounger  
Reposa-cabeza tumbona

**C0006W**



cat D  
cat E  
cat F

Head support lounger Round  
Reposa-cabeza tumbona

**C0005W**



cat D  
cat E  
cat F

C0005 can be combined with Nodi, Kos, Forum and Ukiyo loungers.  
C0005 puede combinarse con las tumbonas Nodi, Kos, Forum y Ukiyo.

# FABRIC

TEJIDO

cat D  
cat E  
cat F

Fabric per running meter only as part of an existing order and limited to a maximum of 5.5 yards.  
Tejido por metro lineal sólo como parte de un pedido existente y limitado a un máximo de 5 metros.



MANTENIMIENTO

Maintenance products teak  
 Productos de mantenimiento teca

Teak Super Cleaner  
 500 ml

D9914



Teak Protector Grey Color  
 500 ml

D9912



Teak Sealer Natural  
 1000 ml

D9959



Maintenance products stainless steel  
 Productos de mantenimiento acero inoxidable

Inox Super Cleaner (CB & EP)  
 250 ml

D9918



Maintenance products aluminum & powdercoated stainless steel  
 Productos de mantenimiento acero inoxidable y aluminio lacado al polvo

Aluminium Cleaner  
 500 ml

D9952



Aluminium Protector

D9931



Aluminium Protector

D9931



Maintenance products granite  
 Productos de mantenimiento para el granito

Granite Cleaner/Protector  
 500 ml

D9961



Maintenance products fabrics + CTR, Elio, Mood, Regista & Tosca  
 Productos de mantenimiento tejidos + CTR, Elio, Mood, Regista & Tosca

Textile Protector  
 400 ml

D9924





# MAINTENANCE PRODUCTS

## MANTENIMIENTO

Maintenance products synthetic material  
 Productos de mantenimiento material sintético  
 (Batyline®, Canax®, Sunscape, CTR, Elio, Mood, Nodi, Regista & Tosca weave)

Maintenance products ceramic and glazed lava stone  
 Productos de mantenimiento cerámica

Synthetics Super Cleaner  
 500 ml

D9922



Ceramic & Lava stone Cleaner  
 500 ml

D9938



Synthetics Protector  
 500 ml

D9921



Ceramic & Lava stone Protector  
 100 ml

D9955



Maintenance products lightened concrete  
 Productos de mantenimiento para hormigón aligerado

Lightened Concrete Conditioner  
 500 ml

D9962



Oil, Wax & Grease remover  
 250 ml

D9963



Sanding Disc  
 Disco lijador

HT013



Lightened Concrete Care Set  
 Set de mantenimiento para hormigón aligerado

D9964

D9962 + D9963 + HT013 + Brush/Cepillo + Microfiber cloth/paño de microfibra

Correctors  
 Correctores

D9933P	Paint pen aluminum white / Corrector de pintura para aluminio blanco	8 ml
D9934P	Paint pen aluminum black / Corrector de pintura para aluminio negro	8 ml
D9940P	Paint pen aluminum silkgrey / Corrector de pintura para aluminio silkgrey	8 ml
D9941P	Paint pen aluminum earthbrown / Corrector de pintura para aluminio earthbrown	8 ml
D9943P	Paint pen aluminum wengé / Corrector de pintura para aluminio wengé	8 ml
D9955P	Paint pen aluminum linen / Corrector de pintura para aluminio linen	8 ml
D9956-xx	Aluminum corrector (00-white, 10-linen, 71-silkgrey, 85-earthbrown, 89-wengé, 90-black)	12ml

Microfiber cloth  
 Paño en microfibra

D9935



40x40cm







# LOW TABLES OVERVIEW

## MESAS AUXILIARES









### ROUND TABLES

Mesas auxiliares redondas

			Ø 35 Ø 13.75"	Ø 40 Ø 15.75"	Ø 48 Ø 19"	Ø 50 Ø 19.75"	Ø 60 Ø 23.5"	Ø 80 Ø 31.5"	Ø 85 Ø 33.5"	Ø 90 Ø 35.5"	Ø 125 Ø 49.25"
DROPS		H30 - H11.75"									
		H40 - H15.75"		D5026			D5027				
		H50 - H19.75"									
DUNES		H50 - H19.75"			D8300						
		H40 - H15.75"					D8302				
NATAL ALU X		H45 - H17.75"	06176								
OTTO		H45 - H17.75"			04280		04282				
		H32 - H12.5"			04281		04283			04284	
T-TABLE		H35 - H13.75"						D2168		D2164	D2165

### SQUARE TABLES

Mesas auxiliares cuadradas

			40x40 15.75x15.75"	42x45 16.5x17.75"	48x54 19x21.25"	60x60 23.5x23.5"	66x66 26x26"	80x80 31.5"x31.5"	90x90 35.5"x35.5"	99x99 39x39"	102x102 40.25"	121x121 47.75x47.75"
KOS		H25 H9.75"		04090								
MOOD		H28 H11"					06282					
NATAL ALU X		H35 H13.75"	06180			06182						
TAO		H37 H14.5"						01682				
T-TABLE		H35 H13.75"							D2173			
TOSCA		H49,5 H19.5"			05381							
UKIYO		H36 14.25"									07586	
VIS A VIS		H18 H7"								01781		01786







# LOW TABLES OVERVIEW

## MESAS AUXILIARES

### RECTANGULAR TABLES

Mesas auxiliares rectangulares

			120x66 47,25x26"	98x86 38.5x33.75"	121x99 47.75x39"	159x44 62,5x17,25	160x70 63x27.5"	240x98 94.5x38.5"	298x98 117.25x38.5"
MOOD		H28 H11"	06284						
T-TABLE		H35 H13.75"						D2178	D2179
TOSCA		H31,5 H12.5"		05386					
UKIYO		H36 14.25"					07588		
VIS A VIS		H18 H7"			01784	01732			

### MISCELLANEOUS

Varia

			30x30 11.75x11.75"	35x40 13.75x15.75"	Ø 50 Ø 19,75"	Ø 69 Ø 27.25"
C-TABLE TEAK		H48 H19"		01285		
ROOTS		H40 H15.75"	D8102			
TAIRU		H40 H15.75"	D8103			
HEXAGON		H31 H12.25"				D5040
		H49 H19.25"			D5041	









# DINING TABLES - OVERVIEW BY SIZE

MESA DE COMEDOR

## BISTRO / BALCONY TABLES

Mesas bistro/balcón

		 2 SEATS	 2+2 SEATS
BRANCH		<b>07671</b> 80x80 31.5x31.5"	<b>07670</b> 90x90 35.5x35.5"
ILLUM			<b>06573</b> 100x100 39.5x39.5"
ILLUM TEAK			<b>06573-T</b> 100x100 39.5x39.5"
KOS			<b>04073</b> 98x98 38.5x38.5"
T-TABLE			<b>D2170</b> 90x90 35.5x35.5"
T-TABLE LOW DINING			<b>D2172</b> 90x90 35.5x35.5"
VIS A VIS			<b>01773</b> 99x99 39x39"

## ROUND TABLES

Mesas redondas

		 3 SEATS	 4 SEATS	 6 SEATS	 7 SEATS
BRANCH		<b>07660</b> Ø80 Ø31.5"	<b>07662</b> Ø 125 cm Ø 49.25"		
OTTO				<b>04266</b> Ø 148 cm Ø58,25"	
T-TABLE		<b>D2166</b> Ø80 Ø31.5"	<b>D2160</b> Ø90 Ø35.5" <b>D2162</b> Ø 125 cm Ø 49.25"		
T-TABLE LOW DINING		<b>D2167</b> Ø80 Ø31.5"	<b>D2161</b> Ø90 Ø35.5" <b>D2163</b> Ø 125 cm Ø 49.25"		
TAO				<b>01666</b> Ø 160 cm Ø 63"	<b>01668</b> Ø 180 cm Ø 71"

\* This guide is based on an average chair width of 21.75".

\*Esta guía se basa en una anchura media de una silla de 55 cm.























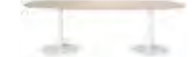

# DINING TABLES - OVERVIEW BY SIZE

MESA DE COMEDOR

## RECTANGULAR TABLES

Mesas rectangulares

										
			4 SEATS	4+2 SEATS	6+2 SEATS	8+2 SEATS	10+2 SEATS	12+2 SEATS	14+2 SEATS	16+2 SEATS
AMANU						<b>02652</b> 290x98 114.25x38.5"	<b>02654</b> 350x98 137.75x38.5"			
BRANCH					<b>07652</b> 210x98 82.75x38.5"	<b>07654</b> 300x110 118x43.25"				
ILLUM			<b>06550</b> 152x100 60x39.5"	<b>06552xs</b> 212x71 83.5x28"	<b>06552</b> 212x100 83.5x39.5"	<b>06554xs</b> 267x71 105x28"	<b>06554</b> 267x100 105x39.5"			
ILLUM TEAK			<b>06550-T</b> 152x100 60x39.5"	<b>06552xs-T</b> 212x73 83.5x28.75"	<b>06552-T</b> 212x100 83.5x39.5"	<b>06554-T</b> 267x100 105x39.5"				
KOS					<b>04052</b> 224x100 88x39.5"	<b>04053</b> 266x100 104.75x39.5"	<b>04054</b> 308x110 121.25x39.5"			
NOX						<b>02252</b> 264x99 104x39"	<b>02254</b> 352x99 138.5x39"			
OTTO						<b>04254</b> 320x110 126x43.25"	<b>04253</b> 290x110 114.25x43.25"			
SURO					<b>02752</b> 210x110 82.75x43.25"	<b>02753</b> 280x110 110.25x42.25"	<b>02754</b> 420x110 165.35x42.25"	<b>02755</b> 490x110 192.91x42.25"	<b>02756</b> 560x110 220.47x42.25"	<b>02757</b> 630x110 248.03x42.25"
T-TABLE		<b>D2183</b> 136x80 53.54x31.5"				<b>D2175</b> 240x98 94.5x38.5"	<b>D2176</b> 298x98 117.25x38.5"			
T-TABLE LOW DINING		<b>D2184</b> 136x80 53.54x31.5"				<b>D2177</b> 240x98 94.5x38.5"	<b>D2178</b> 298x98 117.25x38.5"			
TAO					<b>01670</b> 120x240cm 47.25x94.5"					
TOSCA					<b>05355</b> 240x98 94.5x38.5"	<b>05354</b> 298x98 117.25x38.5"				
UKIYO						<b>07553</b> 271x104 106.75x41"				
VIS A VIS						<b>01753</b> 300x99 118x39"	<b>01754</b> 400x99 157.5x39"	<b>01755</b> 500x99 197x39"	<b>01756</b> 600x99 236.25x39"	<b>01757</b> 700x99 275.5x39"



# DINING TABLES - OVERVIEW BY MATERIALS







## CHOOSE YOUR FRAME

Elija su estructura

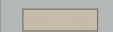
	POWDERCOATED METAL			TEAK	CONCRETE	
	METAL PINTADO EN POLVO			TEAK	HORMIGÓN	
	00-White	10-Linen	89-Wengé		10-Linen	89-Wengé
						
AMANU				X		
BRANCH	X	X	X			
ILLUM	X	X	X	X		
KOS				X		
NOX	X	X	X			
OTTO				X		
SURO				X		
TAO					X	X
TOSCA		X	X			
T-TABLE	X	X	X			
UKIYO				X		
VIS-À-VIS				X		

## CHOOSE YOUR TABLETOP

Elige su tablero de mesa

	ALUMINUM			TEAK	CERAMIC			
	ALUMINIO			TEAK	CERÁMICA			
	00-White	10-Linen	89-Wengé		10-Linen	15-Sabbia	80-Scisto	89-Piombo
								
AMANU						X	X	
BRANCH	X	X	X	X				
ILLUM				X	X	X	X	X
ILLUM TEAK				X	X	X	X	X
KOS				X				
NOX						X	X	
OTTO						X	X	
SURO				X				
TOSCA					X	X	X	X
T-TABLE				X	X	X	X	X
UKIYO				X	X	X	X	X
VIS-à-VIS				X				

	GRANITE	GLAZED LAVA STONE				CONCRETE		TRAVERTINE
	GRANITO	PIEDRA DE LAVA				HORMIGÓN		TRAVERTINO
		L10-Linen	L30-Moss	L70-Ocean	L89-Wengé	10-Linen	89-Wengé	TV-Travertine
								
BRANCH	X							
NOX		X	X	X				
OTTO								X
T-TABLE		X	X		X			
TAO						X	X	



# COVERS FOR SOFA'S

## LISTADO POR MATERIALES

Custom covers = \$255 per single seat and \$515 for meridienne and daybed modules. You will receive 1 cover, that is made exactly to the size of your modular sofa with a tolerance of 5 cm/1.96" around, that leaves a little space for throw pillows.

Fundas a medida = \$255 por asiento individual y \$515 para módulos meridienne y daybed. Recibirá 1 funda cortada a la medida exacta de su sofá modular, con una tolerancia de 5 cm en todo el contorno, dejando algo de espacio para los cojines decorativos.

### NATAL ALU SOFA

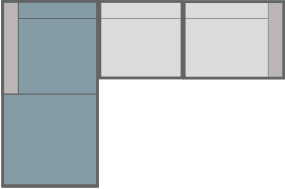

### NODI SOFA

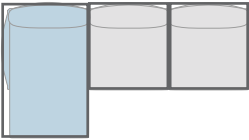

### PURE SOFA



### SENJA SOFA

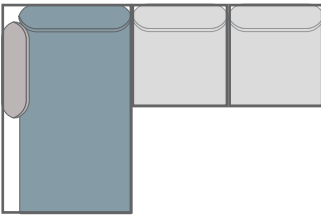

### VIS À VIS SOFA

Covers cover only the cushions, not the borders or tables. In case you order a high back cushion, please indicate the position on your set.  
Las fundas solo cubren los cojines, no los bordes o las mesas. Si usted ordena un cojín de respaldo alto, por favor indique su posición en su juego.





**FUNDAS PARA MESAS**

Covers in PU-breathable material. Color grey.  
Funda protectora transpirable PU. Color gris.

Protection against dirt, not 100% waterproof.  
Resistente a la suciedad, no 100% impermeable.

COLLECTIONS	ART. NR.	TABLE DIMENSIONS
AMANU	D7290-100-A/B/C D7350-100-A/B/C	290 x 98cm - 114.25 x 38.5" 350 x 98cm - 137.75 x 38.5"
BRANCH	D7080-A/C D7125-A/C D7080-80-A/B/C D7090-90-A/B/C D7210-98-A/B/C D7300-110-A/B/C	Dia80cm - Dia31.5" Dia125cm - Dia49.25" 80 x 80cm - 31.5 x 31.5" 90 x 90cm - 35.5 x 35.5" 210 x 98cm - 82.75 x 38.5" 300 x 110cm - 118 x 43.25"
ILLUM	D7210-71-A/B/C D7210-73-A/B/C D7265-71-A/B/C D7100-100-A/B/C D7152-100-A/B/C D7210-98-A/B/C D7265-98-A/B/C	212 x 71cm - 83.5 x 28" 212 x 73cm - 83.5 x 28.75" 267 x 71cm - 105 x 28" 100 x 100cm - 39.5 x 39.5" 152 x 100cm - 60 x 39.5" 212 x 100cm - 83.5 x 39.5" 267 x 100cm - 105 x 39.5"
ILLUM COUNTERHEIGHT	D6560-100-A/B/C D6564-71-A/B/C	152 x 100cm - 60 x 39.5" 212 x 71cm - 83.5 x 28"
KOS	D7100-100-A/B/C D7223-100-A/B/C D7265-100-A/B/C D7300-110-A/B/C	98 x 98cm - 38.5 x 38.5" 224 x 100cm - 88 x 39.5" 266 x 100cm - 104.75 x 39.5" 308 x 110cm - 121.25 x 43.25"
NOX	D7265-100-A/B/C D7360-100-A/B/C	264 x 99cm - 104 x 39" 352 x 99cm - 138.5 x 39"
OTTO DINING	D7148-A/C D7320-110-A/B/C	Dia 148cm - 58.25" 320 x 110cm - 126 x 43.25"
SURO	D7210-110-A/B/C D7280-110-A/B/C D7420-110-A/B/C D7490-110-A/B/C D7560-110-A/B/C D7630-110-A/B/C	210 x 110cm - 82.75 x 43.25" 280 x 110cm - 110.25 x 43.25" 420 x 110cm - 165.25 x 43.25" 490 x 110cm - 193 x 43.25" 560 x 110cm - 220.5 x 43.25" 630 x 110cm - 248 x 43.25"
T-TABLE	D7080-75-A/C D7090-75-A/C D7125-75-A/C D7080-80-A/B/C D7090-90-A/B/C D7240-98-A/B/C D7298-98-A/B/C D7136-80-A/B/C	Dia80cm - Dia31.5" Dia90cm - Dia35.5" Dia125cm - Dia49.25" 80 x 80cm - 31.5 x 31.5" 90 x 90cm - 35.5 x 35.5" 240 x 98cm - 94.5 x 38.5" 298 x 98cm - 117.25 x 38.5" 136 x 80cm - 53.54 x 31.5"
T-TABLE LOW DINING	D7080-67-A/C D7090-67-A/C D7125-67-A/C D7080-80-67-A/B/C D7090-90-67-A/B/C D7240-98-67-A/B/C D7298-98-67-A/B/C D7136-80-67-A/B/C	Dia80cm - Dia31.5" Dia90cm - Dia35.5" Dia125cm - Dia49.25" 80 x 80cm - 31.5 x 31.5" 90 x 90cm - 35.5 x 35.5" 240 x 98cm - 94.5 x 38.5" 298 x 98cm - 117.25 x 38.5" 136x80cm - 53.54 x 31.5"
TAO	D1666-75-A/C D1668-75-A/C D1670-75-A/B/C	Dia160cm - Dia63" Dia180cm - Dia71" 120x240cm - 47.25x-94.5"
TOSCA	D7240-98-A/B/C D7300-98-A/B/C	240 x 98cm - 94.5 x 38.5" 298 x 98cm - 117.25 x 38.5"
UKIYO	D7271-104-A/B/C	271 x 104cm - 106.69 x 40.94"
VIS-À-VIS	D7099-99-A/B/C D7300-99-A/B/C D7400-99-A/B/C D7500-99-A/B/C D7600-99-A/B/C D7700-99-A/B/C	99 x 99cm - 39 x 39" 300 x 99cm - 118 x 39" 400 x 99cm - 157.5 x 39" 500 x 99cm - 197 x 39" 600 x 99cm - 236.25 x 39" 700 x 99cm - 275.5 x 39"

**A**

**A:** Cover for table only.  
Funda solo para la mesa



**B:** Cover for table with chairs. Please specify the type of chairs when ordering.

**B:** Funda para la mesa y la sillas. Gracias por confirmarnos el tipo de silla al pasar el pedido



**C:** Cover for table with chairs at the side and head of the table. Please specify the type of chairs when ordering.

**C:** Funda para la mesa y la sillas a los lados y a la cabecera de la mesa. Gracias por confirmarnos el tipo de silla al pasar el pedido



# COVERS FOR LOW TABLES

## FUNDAS PARA MESAS AUXILIARES

Covers in PU-breathable material. Color grey.  
Funda protectora transpirable PU. Color gris.

Protection against dirt, not 100% waterproof.  
Resistente a la suciedad, no 100% impermeable.

COLLECTIONS	ART. NR.	ART. NR. COVER	TABLE DIMENSIONS
BRANCH	07680	D7680	Dia50 x H27cm - Dia19.75 x H10.75"
	07682	D7682	Dia60 x H27cm - Dia23.5 x H10.75"
	07686	D7686	Dia85 x H27cm - Dia33.5 x H10.75"
	07688	D7688	153 x 85 x H27cm - 60.25 x 33.5 x H10.75"
	07690	D7690	Dia50 x H35cm - Dia19.75 x H13.75"
	07691	D7691	Dia60 x H35cm - Dia23.5 x H13.75"
	07693	D7693	Dia85 x H35cm - Dia33.5 x H13.75"
	07689	D7689	153 x 85 x H35cm - 60.25 x 33.5 x H10.75"
	07681	D7681	Dia50 x H43cm - Dia19.75 x H17"
	07683	D7683	Dia60 x H43cm - Dia23.5 x H17"
	07687	D7687	Dia85 x H43cm - Dia33.5 x H17"
DROPS	D5026	D5030	Dia40 x H 30cm - Dia15.75 x H12.25"
	D5027	D5031	Dia60 x H 30cm - Dia23.5 x H12.25"
DUNES	D8300	D8301	Dia48 x H50cm - Dia19 x H19.75"
	D8302	D8303	Dia60 x H40cm - Dia23,5 x H15.75"
HEXAGON	D5040	D5042	Dia69xH31cm - Dia27.25 x H12.25"
	D5041	D5043	Dia50xH49cm - Dia19.75 x H19.25"
KOS	04090	D6095	42 x 45 x H25cm - 16.5 x 17.75 x H10"
MOOD	06282	D6096	66 x 66 x H28cm - 26x26xH11"
	06284	D6108	120 x 66 x H28cm - 47.25x26xH11"
NATAL ALU	06176	D6176	Dia35 x H45cm - Dia13.75 x H17.75"
	06180	D6180	40 x 40 x H35cm - 15.75 x 15.75 x H13.75"
	06182	D6182	60 x 60 x H35cm - 23.5 x 23.5 x H13.75"
OTTO	04280	D4280	Dia 48cm x H45cm - Dia 19 x H17.75"
	04281	D4281	Dia 48cm x H32cm - Dia 19 x H12.6"
	04282	D4282	Dia 60cm x H45cm - Dia 23.5 x 17.75"
	04283	D4283	Dia 60cm x H32cm - Dia 12.5 x 12.6"
	04284	D4284	Dia 90cm x H32cm - Dia 35.5 x 12.6"
PURE	01285	D6123	42 x 37 x H48cm - 16.53 x 14.56 x 18.89"
ROOTS	D8102	D8101S - Standing D8101L - Lying	30 x 30 x H40cm - 11.75 x 11.75 x H15.75"
TAIRU	D8103	D8101S	30 x 30 x H40cm - 11.75 x 11.75 x H15.75"
T-TABLE	D2168	D7080	Dia80 x H35cm - Dia31.5 x H13.75"
	D2164	D7090	Dia90 x H35cm - Dia35.5 x H13.75"
	D2165	D7125	Dia125 x H35cm - Dia49.25 x H13.75"
	D2173	D7080-80-35	80 x 80 x H35cm - 31.5 x 31.5 x H13.75"
	D2174	D7090-90-35	90 x 90 x H35cm - 35.5 x 35.5 x H13.75"
	D2179	D7240-98-35	240 x 98 x H35cm - 94.5 x 38.5 x H13.75"
	D2180	D7298-98-35	298 x 98 x H35cm - 117.25 x 38.5 x H13.75"
	D2185	D7136-80-35	136 x 80 x H35cm - 53.54 x H31.5 x H13.75"
TAO	01682	D1682	Dia80 x H37cm - Dia31.5 x H14.5"
TOSCA	05381	D5381	54 x 48 x H49,5cm - 21.25 x 19 x H19,5"
	05386	D5386	98 x 86 x H31,5cm - 38.5 x 33.75 x H12,5"
UKIYO	07586	D7586	102 x 102 x 36cm - 40.16 x 40.16 x H14.17"
	07588	D7588	160 x 70 x 36 cm - 63 x 27.56 x H14.17"
VIS-À-VIS	01781	D1781	99 x 99 x H18cm - 39 x 39 x H7"
	01784	D1784	121 x 99 x H18cm - 47.75 x 39 x H7"
	01786	D1786	121 x 121 x H18cm - 47.75 x 47.75 x H7"







A perfect quality is the cornerstone of Tribù's company philosophy. This is guaranteed by a careful selection of the most durable materials, a long term cooperation with industrial partners, each an expert in their field, and a rigorous testing of our models in compliance to both EU and USA standards.

**BIFMA X5- RANGE**

BIFMA (Business and Institutional Furniture Manufacturers Association) is an American standard that sets the acceptance levels and test parameters for evaluating the safety, durability and structural adequacy of contract furniture.

**EN 581-1:2006**

A EU standard that specifies the general safety requirements for seating and tables.

**EN 1728:2012**

A EU standard that specifies the mechanical requirements (strength and stability) and test methods for furniture seating.

**EN 1022:2005 6**

A EU standard that measures the stability of domestic furniture.

**CPSD-HL-01012-MTHD**

Measures the effect of extreme temperature change (24hrs at -17°C/0 °F and 48°C/120°F).

**CPSD-HL-01063-MTHD**

Measures the moisture content of wood, which should be between 8 and 12%.

**CPSD-HL-01010-MTHD/ASTM B117-11**

Measures the resistance to corrosion of metal parts.

**AATCC 16**

Measures the colourfastness to light.

**AATCC106**

Measures the colourfastness to sea water.

**AATCC162**

Measures the colourfastness to chlorinated pool water.

**ASTM B117-11**

Tests the corrosion resistance of coated metals in a controlled atmosphere.

Calidad perfecta es la base de la filosofía empresarial de Tribù. Esta calidad está garantizada por una cuidadosa selección de los materiales más duraderos, una larga colaboración con los mismos socios industriales, cada uno experto en su campo y la prueba extensa de nuestros modelos para cumplir tanto con las normas UE y las normas EE.UU.

**BIFMA X5- range**

BIFMA (Business and Institutional Furniture Manufacturers Association) es una norma americana que establece la aceptación de niveles y los parámetros de prueba para la evaluación de la seguridad, durabilidad y para la adecuación estructural para los muebles de proyectos.

**EN 581-1:2006**

Una norma de la UE que establece los requisitos generales de seguridad para sillas y mesas.

**EN 1728:2012**

Una norma de la UE que establece los requerimientos mecánicos y métodos de prueba (resistencia y estabilidad) para los muebles de asiento.

**EN 1022:2005 6**

Una norma de la UE que mide la estabilidad de los muebles para uso doméstico.

**CPSD-HL-01012-MTHD**

Medir el efecto de la temperatura extrema (24 h a -17 ° c y 48 ° c).

**CPSD-HL-01063-MTHD**

Medir el contenido de humedad de la madera. Esto debe ser entre 8 y 12%.

**CPSD-HL-01010-MTHD/ASTM B117-11**

Medir la resistencia a la corrosión de partes metálicas.

**AATCC 16**

Medir la solidez de los colores a la exposición a la luz.

**AATCC106**

Medir la solidez de los colores cuando se expone al agua de mar.

**AATCC162**

Medir la solidez de los colores cuando se expone al agua de la piscina con cloro.

**ASTM B117-11**

Prueba la resistencia a la corrosión de los metales lacados en una atmósfera controlada.



AMANU (p. 8)  
loung chair

ANSI/BIFMA X5.1-2017



BRANCH (p. 10)  
side chair, armchair

ANSI/BIFMA X5.1-2011

EN1022:2005 6  
EN581-1:2006 5  
EN 1728:2012

ASTM B117-11 (Mod.)

CPSD-HL-01010-MTHD  
CPSD-HL-01012-MTHD



CTR (p. 14)  
armchair

ANSI/BIFMA X5.1-2011

EN1022:2005 6  
EN581-1:2006 5  
EN 1728:2012

ASTM B117-11 (Mod.)

CPSD-HL-01010-MTHD  
CPSD-HL-01012-MTHD



ILLUM (p. 21)  
armchair

ANSI/BIFMA X5.1-2011

EN1022:2005 6  
EN581-1:2006 5  
EN 1728:2012

ASTM B117-11 (Mod.)

CPSD-HL-01010-MTHD  
CPSD-HL-01012-MTHD



KOS (p. 24)  
armchair, lounge chair

ANSI/BIFMA X5.1-2011

EN1022:2005 6  
EN581-1:2006 5  
EN 1728:2012

CPSD-HL-01063-MTHD  
CPSD-HL-01012-MTHD





MOOD (p. 26-27)  
armchair, lounge chair, bar chair



ANSI/BIFMA X5.1-2011

EN1022:2005 6  
EN581-1:2006 5  
EN 1728:2012

ASTM B117-11 (Mod.)

CPSD-HL-01010-MTHD  
CPSD-HL-01012-MTHD  
CPSD-HL-01063-MTHD

AATCC 16  
AATCC 106  
AATCC 162

NATAL ALU (p. 31)  
armchair



ANSI/BIFMA X5.1-2011

EN1022:2005 6  
EN581-1:2006 5  
EN 1728:2012

ASTM B117-11 (Mod.)

CPSD-HL-01010-MTHD  
CPSD-HL-01012-MTHD

NODI (p. 39)  
armchair, lounge chair



ANSI/BIFMA X5.1-2011

EN1022:2005 6  
EN581-1:2006 5  
EN 1728:2012

ASTM B117-11 (Mod.)

CPSD-HL-01010-MTHD  
CPSD-HL-01012-MTHD

TOSCA (p. 72)  
armchair



ANSI/BIFMA X5.1-2011

EN1022:2005 6  
EN581-1:2006 5  
EN 1728:2012

ASTM B117-11 (Mod.)

CPSD-HL-01010-MTHD  
CPSD-HL-01012-MTHD

AATCC 16  
AATCC 106  
AATCC 162

VIS A VIS (p. 80)  
armchair



ANSI/BIFMA X5.1-2011

EN1022:2005 6  
EN581-1:2006 5  
EN 1728:2012

ASTM B117-11 (Mod.)

CPSD-HL-01010-MTHD  
CPSD-HL-01012-MTHD  
CPSD-HL-01063-MTHD

AATCC 16  
AATCC 106  
AATCC 162



BRANCH (p. 11)  
lounger

ANSI/BIFMA X5.4 - 2012    ASTM B117-11 (Mod.)

CPSD-HL-01010-MTHD  
CPSD-HL-01012-MTHD



FORUM (p. 20)  
lounger

ANSI/BIFMA X5.4 - 2012

EN 581-1:2006 5.1  
EN 581-1:2006 5.2  
EN 581-1:2006 5.3.1  
EN 581-1:2006 5.3.3  
EN 581-1:2006 6.2.1  
  
EN581-2:2009 Annex A  
EN581-2:2009 B.2.1.3  
EN581-2:2009 B.2.1.7  
EN581-2:2009 B.3.1.1  
EN581-2:2009 B.3.1.2

EN1728:2000 6.2.1  
EN1728:2000 6.2.2  
EN1728:2000 6.3  
EN1728:2000 6.7  
EN1728:2000 6.9  
EN1728:2000 6.12  
EN1728:2000 6.13  
EN1728:2000 6.15  
  
EN1022:2005 6.2  
EN1022:2005 6.4  
EN1022:2005 6.6  
EN1022:2005 7.5



KOS (p. 25)  
lounger

ANSI/BIFMA X5.4 - 2012

CPSD-HL-01063-MTHD  
CPSD-HL-01012-MTHD



SENJA (p. 57)  
lounger

ANSI/BIFMA X5.4 - 2012



TOSCA (p. 75)  
lounger

ANSI/BIFMA X5.4 - 2012    ASTM B117-11 (Mod.)

CPSD-HL-01010-MTHD  
CPSD-HL-01012-MTHD

AATCC 16  
AATCC 106  
AATCC 162









# PRICING CUSHIONS

## PRECIOS COJINES

### CATEGORIES

The price of the cushions depends on the type of fabric.  
All of our cushions are made to order and can therefore not be cancelled after 24 h.

	CATEGORY D	CATEGORY E	CATEGORY F
FABRIC	Sunbrella®	Canvas Dalsace Gaelic Knit Linen Natural Rustic Weave Tagika Taman Twist	Naram Sujàn

### CATEGORÍAS

Los precios de los almohadones son determinados por el tipo de tejido.  
Todos nuestros cojines se hacen por encargo y por lo tanto no se pueden cancelar después de 24 horas.

	CATEGORIA D	CATEGORIA E	CATEGORIA F
TISSUTO	Sunbrella®	Canvas Dalsace Gaelic Knit Linen Natural Rustic Weave Tagika Taman Twist	Naram Sujàn



# FIRE RETARDANT CUSHIONS

## COJINES IGNÍFUGOS

---

For projects, Tribù is able to offer fire retardant cushions (foam and fabric).

We are happy to work with you on your project and find the best solution.  
Please do not hesitate to contact our contract department ([teamcontract@tribu.com](mailto:teamcontract@tribu.com)) for a tailored solution.

---

Para proyectos Tribù puede ofrecer cojines ignífugos (relleno y tejido)

Estaremos encantados de trabajar con usted en su proyecto y encontrar la mejor idea.  
Póngase en contacto con nuestro departamento de proyectos ([teamcontract@tribu.com](mailto:teamcontract@tribu.com)) para una solución a su medida.



## SUNBRELLA®



01 - Natté White



03 - Oyster



06 - Natté Dune

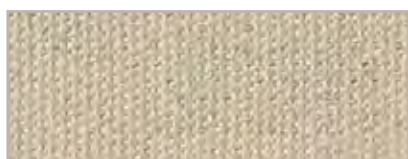

07 - Papyrus\*



08 - Natté Carbon Sky



10 - Curaçao



11 - Blush

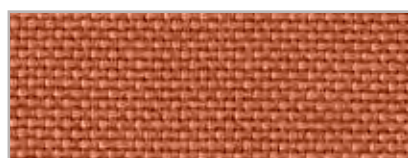

13 - Indian Summer



15 - Ashe\*



34 - Natté Frost Chiné



40 - Natté Olive



42 - Leaf\*



44 - Natté Anis



45 - Natté Mist



46 - Natté Stardust

\*This fabric is made with recycled fabric. Due to its specific character, it may show irregularities.

\*Esta tela está hecha con un tela reciclada por la cual puedan ocurrir pequeñas irregularidades en la tela.

Smooth fabrics are less prone to looping  
Los tejidos lisos son menos propensos a formar bucles



# COLORS - COLORES

CAT. D

---



47 - Natté Ochre



64 - Natté Nature grey



65 - Natté Basalt



69 - Natté Silvergrey



75 - Natté Charcoal



76 - Granite\*



89 - Natté Wengé



# COLORS - COLORES

CAT. E

---

## GAELIC



E22 - Pearl



E23 - Glacier



E25 - Sandstone



E27 - Mushroom



E29 - Dark Copper



E30 - Ochre

## DALSACE



B41 - Dalsace Canvas



B42 - Dalsace Flax



B43 - Dalsace Snow Grey



B44 - Dalsace Zinc



TUV

B45 - Dalsace Night

Smooth fabrics are less prone to looping  
Los tejidos lisos son menos propensos a formar bucles



CAT. E

---

## LINEN



B12 - Linen



B13 - Chalk



B15 - Washed Linen



B54 - Linen Oyster



B55 - Linen Scisto

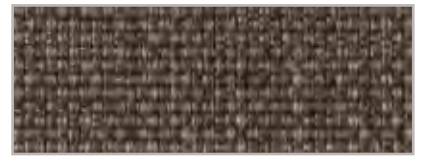

B57 - Linen Grey



B69 - Silverstone



## TWIST



B10 - Twist Linen

## KNIT

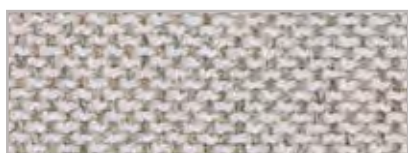

E32 - Morning Dew



E34 - Silverstone



E38 - Iris

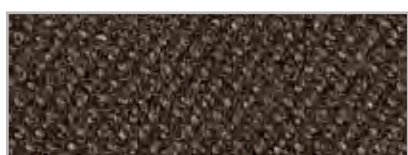

E39 - Wengé

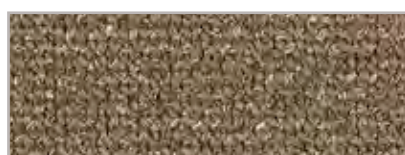

E43 - Rosemary

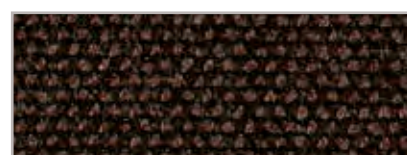

E44 - Licorice



E45 - Mellow Ochre

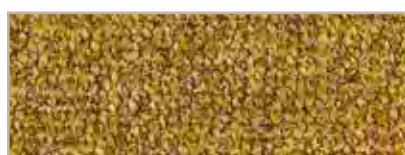

E46 - Colorado



E48 - Dark Copper

Smooth fabrics are less prone to looping  
Los tejidos lisos son menos propensos a formar bucles



# COLORS - COLORES

CAT.E

---

## CANVAS



B110 - Canvas Cotton White



B111 - Canvas Tweed Brown

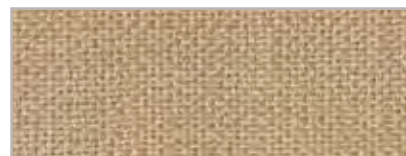

B112 - Canvas Tuscan Linen

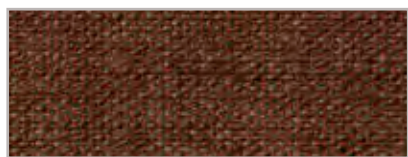

B114 - Canvas Merlot Red



B116 - Canvas Mandarin

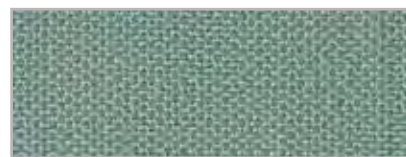

B117 - Canvas Azure Blue



B118 - Canvas Lace

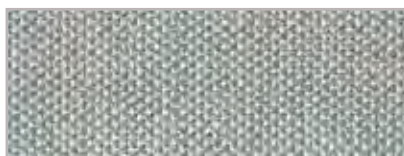

B119 - Canvas Seaside Blue



B120 - Canvas Seasalt



B121 - Canvas Seagrass



## NATURAL

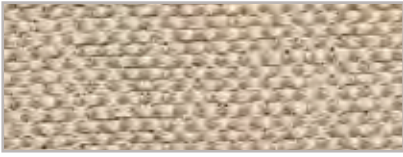

B154 - Natural Seashell



B155 - Natural Cloudy Sky



B156 - Natural Aged Ivory



B157 - Natural Umbra



B160 - Natural Aquamarine

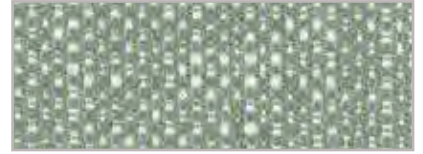

B190 - Natural Sage Green



B191 - Natural Sandy Dunes

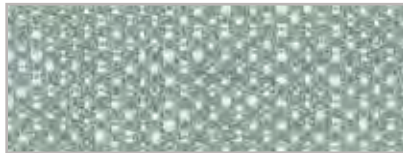

B192 - Natural Pale Blue

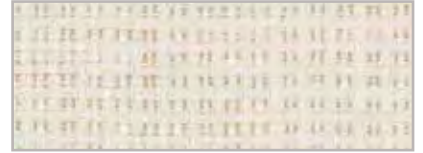

B193 - Natural Off-White

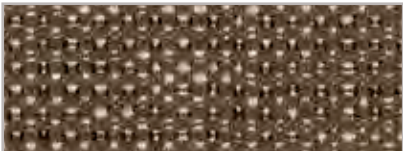

B194 - Natural Dark Brown



CAT. E

---

## RUSTIC WEAVE



B140 - Rustic Weave Dark Grey



B142 - Rustic Weave Moss

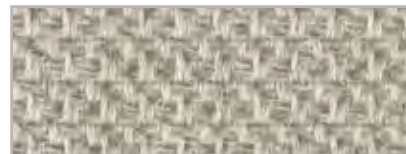

B143 - Rustic Weave Oyster



B144 - Rustic Weave Cord

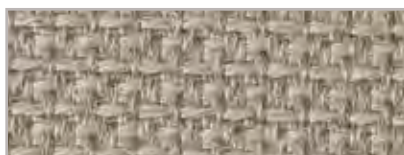

B146 - Rustic Weave Ice Grey

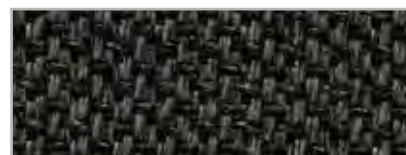

B147 - Rustic Weave Black



B150 - Rustic Weave Abricot

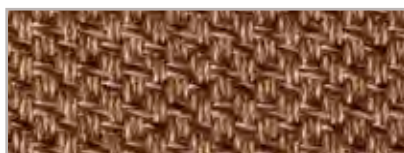

B151 - Rustic Weave Brown

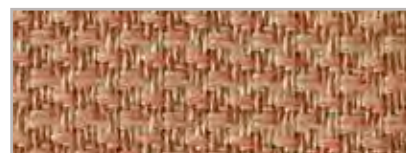

B152 - Rustic Weave Fresco



B153 - Rustic Weave Lagoon



## TAGIKA



B180 - Tagika White



B181 - Tagika Mist

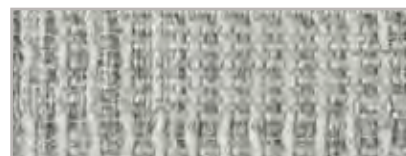

B182 - Tagika Silvergrey



B183 - Tagika Terracotta



B184 - Tagika Fresco

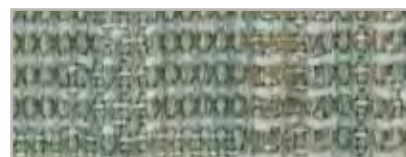

B185 - Tagika Eucalyptus



B186 - Tagika Scisto



B187 - Tagika Nature Grey

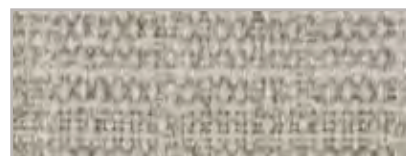

B188 - Tagika Oyster



B189 - Tagika Moss



# COLORS - COLORES

CAT. E

---

## TAMAN



B170 - Taman Silver



B171 - Taman Off-Black



B172 - Taman Basalt



B173 - Taman Poivre



B174 - Taman Linen



B175 - Taman White Sand



B176 - Taman White



CAT.F

## SUJÀN

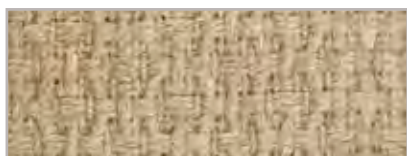

F01 - Sujàn Hemp



F02 - Sujàn Moss



F04 - Sujàn Ochre

## NARAM



F19 - Pearl



F20 - Almond



F21 - Warm Cotton



# COLORS - COLORES

PAVILION

---

## SUNSCAPE



S54 - Sunscape Oyster



S64 - Sunscape Nature Grey



S70 - Sunscape Stone

## VELUM



V54 - Velum Oyster



V64 - Velum Nature Grey



V70 - Velum Stone



## OUTDOOR FILLING

All our cushions are weatherproof, which means you can leave them outside, even during short periods of rain. To preserve the beautiful appearance of the cushions, it is best to keep them indoors during autumn and winter. Depending on the design of the cushions, there are 2 different systems:

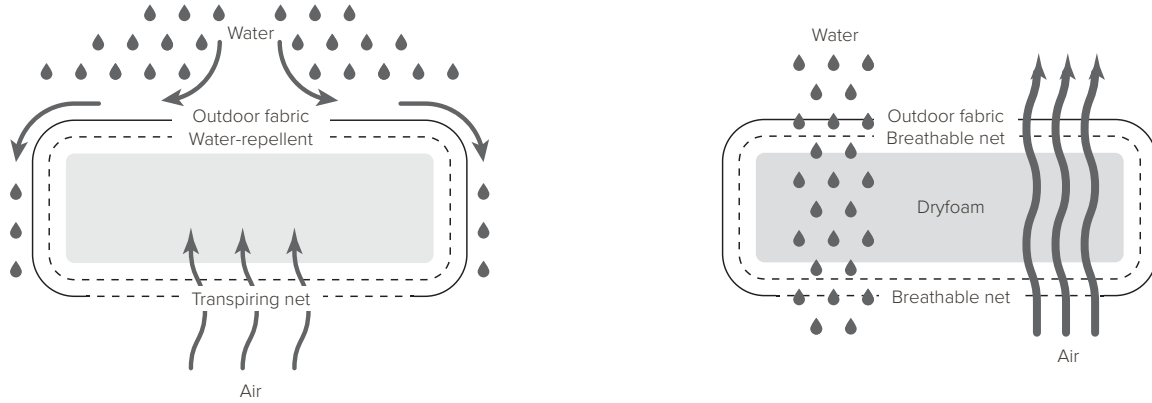

**water-repellent fillings** have a cover in a laminated, water-repellent polypropylene material which prevents water from penetrating. The thread used to stitch the seams swells when getting wet, preventing water from penetrating through the seams. On top of that, the seams are protected on the inside with an extra covering. If nevertheless water should penetrate, the material is breathable, letting moisture out to prevent molding.

(AMANU, CTR BACK CUSHIONS, ELIO, MOOD SOFA, NATAL ALU SOFA, NODI SOFA, NOMAD EASY CHAIR, PURE SOFA CASUAL, SENJA, TOSCA AND VIS À VIS SOFA)

**water-permeable fillings (dryfoam)** have an open cell structure so air can circulate freely. Water passes through the filling but dries quickly thanks to the large open pores, substantially inhibiting fungal growth.

(CTR SEAT CUSHIONS, NODI, PAVILION DAYBED, PURE SOFA MIAMI, REGISTA, KOS)

## NODI SOFA, an incomparable comfort

In addition to the water-repellent properties mentioned above, the cushions of our Nodi Sofa are filled with an innovative, new generation material with a remarkable softness, outstanding shape-retention and excellent breathability.

This new, natural and recyclable polyester fibre is set to change the world of synthetic foams and fibres used for cushion fillings. As a result of its unique molecular structure, it maintains its bounce even after repeated compressions and quickly recovers its airy volume. Thanks to its high durability, its

unique texture is retained for a long time.

Nodi's back cushions consist of compartments fully filled with this new fibre, combined with recycled memory-foam particles. This provides excellent support and form stability.

The seat cushions are filled with high quality PU foam with a padding in non-carded microfibre that has been developed for its softness, fluffiness and comfort, creating a seat cushion with the same performance as feathers and down.



Outstanding softness

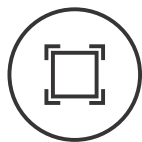

Excellent shape retention



Comfortable stretch



Highly ecological

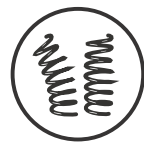

Superior rebound



## RELLENOS PARA EXTERIOR

Todos nuestros cojines son impermeables, lo que significa que se pueden dejar afuera, incluso durante periodos cortos de lluvia. Para mantener la hermosa apariencia de los cojines, es mejor mantenerlos en el interior durante el otoño y el invierno. Dependiendo del diseño de los cojines, hay dos diferentes sistemas:

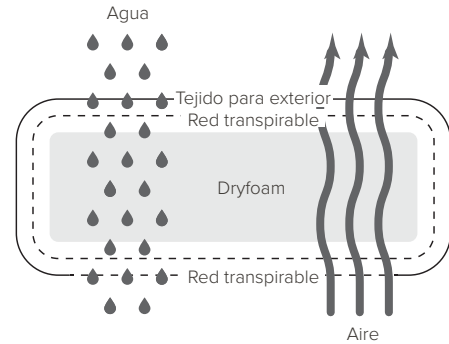
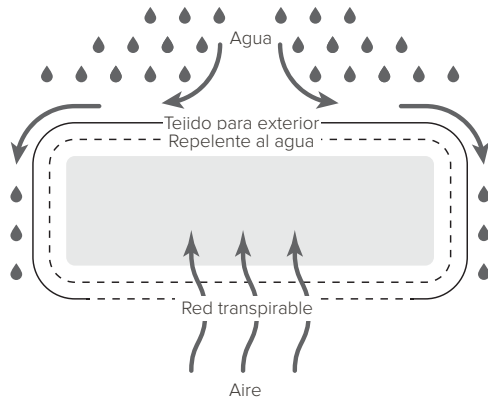

los cojines impermeables tienen alrededor del relleno una funda de polipropileno laminado impermeable que impide que el agua entre en el relleno. El hilo utilizado para las costuras se infla cuando se moja, de modo que el agua tampoco puede entrar por las costuras. Además, la cara interna de las costuras también está protegida por una funda adicional. Si, a pesar de todo, el agua lograra penetrar, la humedad puede salir, ya que el relleno es transpirable.

(AMANU, CTR COJINES RESPALDO, ELIO, MOOD SOFA, NATAL ALU SOFA, NODI SOFA, NOMAD EASY CHAIR, PURE SOFA CASUAL, SENJA, TOSCA AND VIS À VIS SOFA)

los cojines permeables al agua (los de espuma seca) tienen una estructura celular abierta que permite que el aire circule libremente. El agua penetra en el relleno, pero se seca rápidamente gracias a los poros grandes y abiertos, de modo que las posibilidades de formación de moho son muy escasas. (CTR COJINES DE ASIENTO, NODI, PAVILION DAYBED, PURE SOFA MIAMI, REGISTA, KOS)

## SOFÀ NODI, un confort incomparable

Además de las propiedades impermeables mencionadas anteriormente, los cojines de nuestro sofá Nodi Sofa están rellenos de un innovador material de última generación, extraordinariamente mullido y con una transpirabilidad excelente, que además conserva su forma de manera excepcional.

Esta nueva fibra de poliéster natural y reciclable establecerá un antes y un después en el mundo de las fibras y las espumas sintéticas utilizadas en los rellenos de cojín. Incluso después de ser sometido a repetidas presiones, mantiene sus propiedades para recuperar su forma original y su esponjoso volumen. Gracias a su alta durabilidad, su textura única su

forma original durante mucho tiempo.

Los cojines del respaldo del sofá Nodi están compuestos por compartimentos totalmente rellenos de esta nueva fibra, en combinación con partículas de espuma viscoelástica recicladas, lo que proporciona un apoyo excelente y evita que se deformen.

Por su parte, los cojines del asiento están rellenos de espuma de poliuretano de alta calidad, con un acolchado en microfibra, que se caracteriza por ser mullida, esponjosa y cómoda. En definitiva, todo ello permite obtener un cojín de asiento con los mismos resultados que las plumas y el plumón.



Extramullido



Excelente conservación de la forma

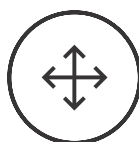

Elasticidad y comodidad



Altamente ecológico



Resistencia superior



# FABRIC TYPES

## TIPOS DE TEJIDOS

### INFORMATION

Tribù offers a selection of 118 different outdoor fabrics, all carefully chosen to match our discreet luxury character. Each fabric is engineered with high performance characteristics that provide resistance to fading from sunlight and offer a long life. Durable, yet very tactile. Within our range, we work with 3 different fabric types, see overview beneath. You can find more info on these fabric types on the following pages.

### INFORMACIÓN

Tribù dispone de una gama de aproximadamente 118 tipos de tejidos para exterior, todos ellos seleccionados cuidadosamente para mantener el lujo propio de nuestra marca. Todos los tejidos han sido producidos con características de alto rendimiento, son resistentes a los efectos del sol y garantizan una prolongada vida útil. Resistentes, pero aún así muy agradables al tacto. Dentro de nuestra gama trabajamos con 3 tipos de tejidos, consulte la tabla de abajo. En las páginas siguientes encontrará más información al respecto.

	SOLUTION DYED ACRYLIC	SOLUTION DYED POLYOLEFIN	PVC COATED POLYESTER
Canvas	x		
Dalsace	x		
Gealic		x	
Knit		x	
Linen	x	x	
Naram	x		
Natural	x		
Rustic Weave	x		
Sujàn	x		
Sunbrella®	x		
Sunscape	x		x
Tagika		x	
Taman		x	
Twist		x	
Velum	x		

Smooth fabrics are less prone to looping  
Los tejidos lisos son menos propensos a formar bucles



SUNBRELLA®, CANVAS, DALSACE, LINEN, NATURAL, NARAM, RUSTIC WEAVE, SUJÀN

---



### INFORMATION

Acrylic fabrics are durable, high-performance synthetic fabrics made from acrylic fibers. They have a number of advantages including mildew-resistant properties and a minimal absorbency of liquids. The acrylics Tribù uses are solution-dyed which means that they are dyed before the yarn is created. A liquid acrylic solution is mixed with the dye and is then formed into a fiber so it already has color before it is spun into a yarn. This process guarantees an optimal colour fastness. Their ability to breathe prevents mold from building up on the surfaces of the fabric. The open weave provides air flow helping to reduce heat and humidity. In addition to the technical performance, acrylic fabrics have a very soft look and feel, creating the perfect ambiance for your outdoor furniture. Our solution dyed fabrics are treated with a special Teflon® coating to make them water repellent and resistant to stains, grease, fluids and salt or chlorine water.

### MAINTENANCE

The covers of all our cushions can be removed and cleaned. All solution dyed acrylics can be washed at 30° C. After washing we recommend to apply Textile Protector (p. 189) which provides the fabric with an invisible, water- and stain repellent film.

---

### INFORMACIÓN

Los tejidos acrílicos son duraderos y de alta calidad, elaborados a partir de fibras acrílicas. Tienen varias ventajas, como una alta resistencia al moho y una mínima absorción de líquidos. El acrílico que Tribù utiliza está coloreado en masa. Esto significa que las fibras se han coloreado antes de fabricar el hilo. Se mezcla una solución acrílica líquida con el tinte y a continuación se crea una fibra que ya tiene todo su color antes de elaborar el hilo con ella. Este proceso garantiza una estabilidad óptima del color (una resistencia al envejecimiento del color de 7/8) gracias a su transpirabilidad, no da cabida al moho. El tejido abierto también favorece a la circulación de aire, por lo que los tejidos no se calientan ni se quedan pegajosos. Además de sus extraordinarias características técnicas, los tejidos acrílicos también tienen un aspecto y un tacto suave, de modo que le ayudarán a crear el ambiente perfecto en su terraza. Todos nuestros tejidos han recibido un tratamiento con Teflon®, por lo que son impermeables, evitan la adherencia de la suciedad y las grasas y son resistentes al agua salada y clorada.

### MANTENIMIENTO

Todas las fundas de almohadones se pueden quitar y lavar. Los tejidos acrílicos se pueden lavar a 30° C. Después de cada lavado, recomendamos aplicar Textile Protector (pág. 189) para crear una película invisible e impermeable que evita la adherencia de la suciedad.



# SOLUTION DYED POLYOLEFIN

POLIOLEFINA COLOREADA EN MASA

---

KNIT, LINEN, TAGIKA, TAMAN, TWIST

---



## INFORMATION

Solution dyed polyolefin fabrics are the perfect combination of ecology (100% recycable), durability and performance, being twice as strong as acrylics. Polyolefin fabrics are resistant to water, mildew and stains. Combined with their high abrasion and pilling resistance, it makes them the perfect fabrics for your outdoor furniture. Their UV-resistance is dependent on the colour and might be lower than solution dyed acrylic fabrics (test results can be found on the back of your sample swatch and on p. 138-143). In case of lower results, slight fading of the colour might occur after 2 years.

## MAINTENANCE

The cover of all our cushions can be removed and cleaned. All solution-dyed polyolefin fabrics can be washed at 30° C. After washing we recommend to apply Textile Protector (p. 189) which provides the fabric with an invisible, water- and stain repellent film.

---

## INFORMACIÓN

Los tejidos de poliolefina coloreados en masa son la combinación perfecta de respeto por el medio ambiente (100 % reciclable), durabilidad y prestación. Son dos veces más resistentes que el acrílico. Los tejidos de poliolefina son resistentes al agua, el moho y las manchas. En combinación con su alta resistencia al desgaste y la formación de pelusas, son los tejidos perfectos para su sofá de exterior. Su resistencia a los rayos ultravioleta depende del color y podría ser inferior a la de los tejidos acrílicos coloreados en masa (puede consultar los resultados de las pruebas en el reverso del paquete de muestras de tejidos o en la pág. 138-143). En caso de que presenten una resistencia más baja, el color puede aclararse después de 2 años.

## MANTENIMIENTO

Todas las fundas de almohadones se pueden quitar y lavar. Todos los tejidos de poliolefina se pueden lavar a 30 °C después de cada lavado, recomendamos aplicar Textile Protector (pág. 189) para crear una película invisible e impermeable que evita la adherencia de la suciedad.



# PVC COATED POLYESTER

POLIÉSTER RECUBIERTO DE PVC

---

SUNSCAPE

---



## INFORMATION

These fabrics are composed of polyester that is coated with PVC. The polyester provides strength and dimensional stability, while the PVC coating makes the material waterproof and resistant to dirt, mildew, oil, salt, chemicals and UV rays. It also gives the material added strength and durability.

## MAINTENANCE

PVC coated fabrics are very maintenance friendly and can easily be cleaned with clear water, a pH- neutral soap and a soft brush. Rinse with clear water. Stubborn stains can be removed with Synthetics Super Cleaner (p. 188).

---

## INFORMACIÓN

Estos tejidos se han elaborado a partir de hilo de poliolefina recubierto de PVC. La poliolefina ofrece resistencia y estabilidad dimensional, mientras que el recubrimiento de PVC impermeabiliza el material y lo hace resistente a la suciedad, el moho, el aceite, la sal, los productos químicos y los rayos ultravioleta. Además, también lo hace más sólido y duradero.

## MANTENIMIENTO

Los tejidos requieren un mantenimiento muy sencillo y se pueden limpiar fácilmente con agua y un detergente líquido Ph neutro. Enjuagar con agua y Synthetics Super Cleaner (p. 188).



# FABRIC PROPERTIES

## PROPIEDADES DE LA TELA

	Code	Category	Composition	Weight (g/m <sup>2</sup> )
<b>SUNBRELLA®</b>				
Natté White	01	Cat. D	Sunbrella® Solution dyed acrylic	275
Oyster	03	Cat. D	Sunbrella® Solution dyed acrylic	280
Natté Dune	06	Cat. D	Sunbrella® Solution dyed acrylic	275
Papyrus*	07	Cat. D	Sunbrella® 50% recycled acrylic - 47% acrylic - 3% PE	340
Natté Carbon Sky	08	Cat. D	Sunbrella® Solution dyed acrylic	275
Curaçao	10	Cat. D	Sunbrella® Solution dyed acrylic	260
Blush	11	Cat. D	Sunbrella® Solution dyed acrylic	260
Indian Summer	13	Cat. D	Solution dyed acrylic	275
Ashe*	15	Cat. D	Sunbrella® 50% recycled acrylic - 47% acrylic - 3% PE	340
Natté Frost Chiné	34	Cat. D	Sunbrella® Solution dyed acrylic	275
Natté Olive	40	Cat. D	Sunbrella® Solution dyed acrylic	275
Leaf*	42	Cat. D	Sunbrella® 50% recycled acrylic - 47% acrylic - 3% PE	340
Natté Anis	44	Cat. D	Sunbrella® Solution dyed acrylic	275
Natté Mist	45	Cat. D	Sunbrella® Solution dyed acrylic	275
Natté Stardust	46	Cat. D	Sunbrella® Solution dyed acrylic	275
Natté Ochre	47	Cat. D	Sunbrella® solution dyed acrylic	275
Natté Nature Grey	64	Cat. D	Sunbrella® Solution dyed acrylic	275
Natté Basalt	65	Cat. D	Sunbrella® Solution dyed acrylic	275
Natté Silvergrey	69	Cat. D	Sunbrella® Solution dyed acrylic	275
Natté Charcoal	75	Cat. D	Sunbrella® Solution dyed acrylic	275
Granite*	76	Cat. D	Sunbrella® 50% recycled acrylic - 47% acrylic - 3% PE	340
Natté Wengé	89	Cat. D	Sunbrella® Solution dyed acrylic	275

<b>CANVAS</b>				
Cotton White	B110	Cat. E	Solution dyed acrylic	393
Tweed Brown	B111	Cat. E	Solution dyed acrylic	393
Tuscan Linen	B112	Cat. E	Solution dyed acrylic	393
Merlot Red	B114	Cat. E	Solution dyed acrylic	393
Mandarin	B116	Cat. E	Solution dyed acrylic	393
Azure Blue	B117	Cat. E	Solution dyed acrylic	393
Lace	B118	Cat. E	Solution dyed acrylic	393
Seaside Blue	B119	Cat. E	Solution dyed acrylic	393
Seasalt	B120	Cat. E	Solution dyed acrylic	393
Seagrass	B121	Cat. E	Solution dyed acrylic	393

<b>DALSACE</b>				
Canvas	B41	Cat. E	Solution dyed acrylic	780
Flax	B42	Cat. E	Solution dyed acrylic	780
Snow Grey	B43	Cat. E	Solution dyed acrylic	780
Zinc	B44	Cat. E	Solution dyed acrylic	780

<b>GAELIC</b>				
Pearl	E22	Cat. E	97% polypropylene - 3% polyester	745
Glacier	E23	Cat. E	97% polypropylene - 3% polyester	745
Sandstone	E25	Cat. E	97% polypropylene - 3% polyester	745
Mushroom	E27	Cat. E	97% polypropylene - 3% polyester	745
Dark Copper	E29	Cat. E	97% polypropylene - 3% polyester	745
Ochre	E30	Cat. E	97% polypropylene - 3% polyester	745



	Code	Durability		Colour fastness to weathering	Tribù UV-test	Pilling
		Martindale				
<b>SUNBRELLA®</b>						
Natté White	01	25.000		7-8	3-4	5
Oyster	03	20.000		7-8	5	4-5
Natté Dune	06	25.000		7-8	3-4	5
Papyrus*	07	25.000		7-8	3-4	5
Natté Carbon Sky	08	25.000		7-8	4	5
Curaçao	10	25.000		7-8	4	5
Blush	11	25.000		7-8	4	5
Indian Summer	13	12.000		7-8	4	3
Ashe*	15	25.000		7-8	4-5	5
Natté Frost Chiné	34	25.000		7-8	4-5	5
Natté Olive	40	25.000		7-8	4	5
Leaf*	42	25.000		7-8	4-5	5
Natté Anis	44	25.000		7-8	4-5	5
Natté Mist	45	25.000		7-8	4-5	5
Natté Stardust	46	25.000		7-8	4	5
Natté Ochre	47	25.000		7-8	3-4	5
Natté Nature Grey	64	25.000		7-8	4-5	5
Natté Basalt	65	25.000		7-8	4-5	5
Natté Silvergrey	69	25.000		7-8	3-4	5
Natté Charcoal	75	25.000		7-8	4-5	5
Granite*	76	25.000		7-8	4-5	5
Natté Wengé	89	25.000		7-8	4-5	5

<b>CANVAS</b>						
Cotton White	B110	25.000		7-8	4	5
Tweed Brown	B111	25.000		7-8	4-5	5
Tuscan Linen	B112	25.000		7-8	4	5
Merlot Red	B114	25.000		7-8	4-5	5
Mandarin	B116	25.000		7-8	4	5
Azure Blue	B117	25.000		7-8	4-5	5
Lace	B118	25.000		7-8	4	5
Seaside Blue	B119	25.000		7-8	4-5	5
Seasalt	B120	25.000		7-8	4-5	5
Seagrass	B121	25.000		7-8	4-5	5

<b>DALSACE</b>						
Canvas	B41	30.000		7-8	3-4	3-4
Flax	B42	30.000		7-8	4	3-4
Snow Grey	B43	30.000		7-8	4	3-4
Zinc	B44	30.000		7-8	4-5	3-4

<b>Gaelic</b>						
Pearl	E22	>40.000		7	3-4	4-5
Glacier	E23	>40.000		7	3-4	4-5
Sandstone	E25	>40.000		7	3-4	4-5
Mushroom	E27	>40.000		6-7	3	4-5
Dark Copper	E29	>40.000		6-7	2	4-5
Ochre	E30	>40.000		6-7	1	4-5



# FABRIC PROPERTIES

## PROPIEDADES DE LA TELA

	Code	Category	Composition	Weight (g/m <sup>2</sup> )
<b>KNIT</b>				
Morning Dew	E32	Cat. E	100% solution dyed polyolefin	710
Silverstone	E34	Cat. E	100% solution dyed polyolefin	710
Iris	E38	Cat. E	100% solution dyed polyolefin	710
Wengé	E39	Cat. E	100% solution dyed polyolefin	710
Rosemary	E43	Cat. E	100% solution dyed polyolefin	710
Licorice	E44	Cat. E	100% solution dyed polyolefin	710
Mellow Ochre	E45	Cat. E	100% solution dyed polyolefin	710
Colorado	E46	Cat. E	100% solution dyed polyolefin	710
Dark Copper	E48	Cat. E	100% solution dyed polyolefin	710
<b>LINEN</b>				
Linen	B12	Cat. E	Solution dyed polyolefin	380
Chalk	B13	Cat. E	Solution dyed polyolefin	380
Washed linen	B15	Cat. E	Solution dyed polyolefin	380
Oyster	B54	Cat. E	Solution dyed acrylic	650
Scisto	B55	Cat. E	Solution dyed acrylic	650
Grey	B57	Cat. E	Solution dyed polyolefin	415
Silverstone	B69	Cat. E	Solution dyed acrylic	360
<b>NATURAL</b>				
Seashell	B154	Cat. E	Solution dyed acrylic	365
Cloudy Sky	B155	Cat. E	Solution dyed acrylic	365
Aged Ivory	B156	Cat. E	Solution dyed acrylic	365
Umbrá	B157	Cat. E	Solution dyed acrylic	365
Aquamarine	B160	Cat. E	Solution dyed acrylic	365
Sage Green	B190	Cat. E	Solution dyed acrylic	365
Sandy Dunes	B191	Cat. E	Solution dyed acrylic	365
Pale Blue	B192	Cat. E	Solution dyed acrylic	365
Off-White	B193	Cat. E	Solution dyed acrylic	365
Dark Brown	B194	Cat. E	Solution dyed acrylic	365
<b>RUSTIC WEAVE</b>				
Dark Grey	B140	Cat. E	Solution dyed acrylic	400
Moss	B142	Cat. E	Solution dyed acrylic	400
Oyster	B143	Cat. E	Solution dyed acrylic	400
Cord	B144	Cat. E	Solution dyed acrylic	470
Ice Grey	B146	Cat. E	Solution dyed acrylic	470
Black	B147	Cat. E	Solution dyed acrylic	400
Abricot	B150	Cat. E	Solution dyed acrylic	400
Brown	B151	Cat. E	Solution dyed acrylic	400
Fresco	B152	Cat. E	Solution dyed acrylic	400
Lagoon	B153	Cat. E	Solution dyed acrylic	400
<b>TAGIKA</b>				
White	B180	Cat. E	Solution dyed polyolefin	317
Mist	B181	Cat. E	Solution dyed polyolefin	317
Silvergrey	B182	Cat. E	Solution dyed polyolefin	317
Terracotta	B183	Cat. E	Solution dyed polyolefin	317
Fresco	B184	Cat. E	Solution dyed polyolefin	317
Eucalyptus	B185	Cat. E	Solution dyed polyolefin	317
Scisto	B186	Cat. E	Solution dyed polyolefin	317
Nature Grey	B187	Cat. E	Solution dyed polyolefin	317
Oyster	B188	Cat. E	Solution dyed polyolefin	317
Moss	B189	Cat. E	Solution dyed polyolefin	317



Code	Durability		Colour fastness to weathering	Tribù UV-test	Pilling
	Martindale				

KNIT					
Morning Dew	E32	>40.000	7	3-4	4.5
Silverstone	E34	>40.000	7	3-4	4.5
Iris	E38	>40.000	7	3-4	4.5
Wengé	E39	>40.000	7	3-4	4.5
Rosemary	E43	>40.000	7	3-4	4.5
Licrice	E44	>40.000	6-7	3	4.5
Mellow Ochre	E45	>40.000	6-7	3	4.5
Colorado	E46	>40.000	6-7	3	4.5
Dark Copper	E48	>40.000	6-7	3	4.5

LINEN					
Linen	B12	>40.000	6-7	3	4-5
Chalk	B13	>40.000	6-7	4	4-5
Washed linen	B15	>40.000	6-7	4	4-5
Oyster	B54	25.000	7-8	4	4
Scisto	B55	25.000	7-8	4-5	4
Grey	B57	25.000	6-7	3-4	4-5
Silverstone	B69	25.000	8	4	4

NATURAL					
Seashell	B154	25.000	7-8	4	4
Cloudy Sky	B155	25.000	7-8	4-5	4
Aged Ivory	B156	25.000	7-8	4	4
Umbra	B157	25.000	7-8	4-5	4
Aquamarine	B160	25.000	7-8	4	4
Sage Green	B190	25.000	7-8	4	4
Sandy Dunes	B191	25.000	7-8	5	4
Pale Blue	B192	25.000	7-8	5	4
Off-White	B193	25.000	7-8	5	4
Dark Brown	B194	25.000	7-8	5	4

RUSTIC WEAVE					
Dark Grey	B140	12.000	7-8	4	3-4
Moss	B142	12.000	7-8	4-5	3-4
Oyster	B143	12.000	7-8	4	3-4
Cord	B144	21.000	7-8	4	3-4
Ice Grey	B146	21.000	7-8	4	3-4
Black	B147	12.000	7-8	4-5	3-4
Abricot	B150	12.000	7-8	3-4	3-4
Brown	B151	12.000	7-8	4	3-4
Fresco	B152	12.000	7-8	3-4	3-4
Lagoon	B153	12.000	7-8	4	3-4

TAGIKA					
White	B180	20.000	7	4	4
Mist	B181	20.000	7	4-5	4
Silvergrey	B182	20.000	7	4	4
Terracotta	B183	20.000	7	3	4
Fresco	B184	20.000	7	3	4
Eucalyptus	B185	20.000	7	3	4
Scisto	B186	20.000	7	4-5	4
Nature Grey	B187	20.000	7	4-5	4
Oyster	B188	20.000	7	4	4
Moss	B189	20.000	7	3	4



# FABRIC PROPERTIES

## PROPIEDADES DE LA TELA

	Code	Category	Composition	Weight (g/m <sup>2</sup> )
<b>TAMAN</b>				
Silver	B170	Cat. E	Solution dyed polyolefin	1.050
Off-Black	B171	Cat. E	Solution dyed polyolefin	1.050
Basalt	B172	Cat. E	Solution dyed polyolefin	1.050
Poivre	B173	Cat. E	Solution dyed polyolefin	1.050
Linen	B174	Cat. E	Solution dyed polyolefin	1.050
White Sand	B175	Cat. E	Solution dyed polyolefin	1.050
White	B176	Cat. E	Solution dyed polyolefin	1.050
<b>TWIST</b>				
Linen	B10	Cat. E	Solution dyed polyolefin	294
<b>NARAM</b>				
Pearl	F19	Cat. F	Solution dyed acrylic	1.360
Almond	F20	Cat. F	Solution dyed acrylic	1.360
Warm Cotton	F21	Cat. F	Solution dyed acrylic	1.360
<b>SUJÀN</b>				
Hemp	F01	Cat. F	Solution dyed acrylic	1.000
Moss	F02	Cat. F	Solution dyed acrylic	1.000
Ochre	F04	Cat. F	Solution dyed acrylic	1.000
<b>BATYLINE</b>				
White	00		Batyline®	
Silkgrey	71		Batyline® Canatex	
Wengé	89		Batyline®	
<b>PAVILION</b>				
Sunscape Oyster	S54		98% Polyester 2% hemp	600
Sunscape Nature Grey	S64		98% Polyester 2% hemp	600
Sunscape Stone	S70		98% Polyester 2% hemp	600
Velum Oyster	V54		Sunbrella® Solution dyed acrylic	165
Velum Nature Grey	V64		Sunbrella® Solution dyed acrylic	165
Velum Stone	V70		Sunbrella® Solution dyed acrylic	165



Code	Durability		Colour fastness to weathering	Tribù UV-test	Pilling
	Martindale				

TAMAN					
Silver	B170	20.000	>6	4	5
Off-Black	B171	20.000	>6	3-4	5
Basalt	B172	20.000	>6	3-4	5
Poivre	B173	20.000	>6	4	5
Linen	B174	20.000	>6	3-4	5
White Sand	B175	20.000	>6	3	5
White	B176	20.000	>6	3	5

TWIST					
Linen	B10	30.000	7-8	3-4	4

NARAM					
Pearl	F19	25.000	7-8	4-5	4
Almond	F20	25.000	7-8	4-5	4
Warm Cotton	F21	25.000	7-8	4-5	4

SUJÀN					
Hemp	F01	5.000	7-8	4	3-4
Moss	F02	5.000	7-8	4	3-4
Ochre	F04	5.000	7-8	3	3-4

BATYLINE					
White	00	120.000	8	4	-
Silkgrey	71	120.000	8	4	-
Wengé	89	120.000	8	5	-

PAVILION					
Sunscape Oyster	S54	>40.000	8	4	-
Sunscape Nature Grey	S64	>40.000	8	4-5	-
Sunscape Stone	S70	>40.000	8	4	-
Velum Oyster	V54	40.000	7-8	4-5	-
Velum Nature Grey	V64	40.000	7-8	4-5	-
Velum Stone	V70	40.000	7-8	4-5	-



# LEGEND FABRIC PROPERTIES

## EXPLICACIÓN PROPIEDADES DE LA TELA

---

**Abrasion resistance:** fabric's ability to withstand surface wear from rubbing.

**Martindale test**

Fabric is mounted flat and rubbed in a figure eight-like motion using an abrasive surface. The number of cycles endured before the fabric shows an objectionable change in appearance is counted and determines the fabric's abrasion rating.  
20.000 = general contract upholstery  
40.000 = heavy duty upholstery

**Colour fastness**

Colour fastness to weathering (ISO 105-B04):

The fabrics undergo a series of light, rain and temperature changes. The result is expressed in a discoloration degree where grade 1 means full discoloration and grade 8 means no discoloration.

**Tribù UV-test**

The fabrics are tested for UV resistance with an aging accelerator in compliance with ISO standard 4892-2 for 5.000 hours and outdoors in Florida, Indonesia and Belgium. Based on these tests the fabrics are awarded a maximum score of 5.

**Pilling**

The fabric's propensity to pilling. Maximum score is 5 (= least inclined).

---

**Resistencia a la abrasión:** capacidad del tejido para resistir el desgaste por la fricción.

**Prueba Martindale**

El tejido se estira y frota con un movimiento en forma ocho utilizando un abrasivo. El número de ciclos realizados antes de que el tejido muestre un cambio notable en la apariencia se cuenta y determina el índice de abrasión del tejido.  
20.000 = tejido de uso general en el sector contractual  
40.000 = tejido para uso intenso

**Resistencia del color a la intemperie**

Durante la prueba ISO105-BO5, los tejidos se someten a distintos cambios de temperatura y luz, y a la lluvia. El resultado se expresa en grado de decoloración, siendo el grado 1 una decoloración total y el grado 8 una decoloración inexistente.

**Prueba Tribù UV**

Se comprueba la resistencia UV de los tejidos con un acelerador de envejecimiento de conformidad con la norma ISO 4892-2 durante 5.000 horas, así como a los choques térmicos (congelación y sobrecalentamiento). La puntuación máxima es 5.

**Pilling**

La formación de bolitas de fibras enmarañadas, en la superficie de un tejido. El número máximo de puntos es de 5 (= inclinación más baja).







# ALUMINIUM

## ALUMINIO

BRANCH, FORUM, ILLUM, NATAL ALU, PAVILION, SENJA & SURO



### INFORMATION

Aluminium is a non-ferrous metal, which combines great mechanical rigidity with light weight. This makes it especially suitable for furniture. If treated correctly, it has a good resistance to corrosion. By powdercoating aluminium, this corrosion resistance can even be enhanced. After a chemical pre-treatment, an epoxy powder is applied statically and baked. Tribù always uses European, ultra-durable and scratch-resistant polyester powdercoatings that guarantee a UV-resistance of 15 years. For certain collections (Branch & Illum) parts of the frame are die-cast under high pressure which results in a seamless and extremely solid frame. Additionally, an extra epoxy primer coat is applied for these collections.

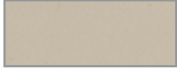

### MAINTENANCE

Powder coated aluminium is easy to clean with clear water and a pH-neutral fluid detergent. Stubborn stains can be removed with Aluminium Cleaner (p. 186). If necessary, use a soft brush to remove the dirt from the pores. To protect the frame against the adhesion of dirt, Aluminium Protector (p. 186) can be used which applies an invisible protective film.



### INFORMACIÓN

El aluminio es un metal no ferroso que combina una alta rigidez mecánica con un peso ligero. Esta característica lo hace especialmente adecuado para la fabricación de mobiliario. Si se trata correctamente, el aluminio ofrece una gran resistencia a la corrosión, que se incrementa todavía más si se pinta en polvo. Tras un tratamiento químico previo, se aplica una pintura en polvo mediante un tratamiento electrostático y posteriormente se cuece.

Tribù utiliza siempre pinturas de poliéster en polvo europeas ultra-durable a los arañazos y con una resistencia a los rayos ultravioleta de 15 años. En determinadas colecciones (Branch y Illum), algunas partes del aluminio se moldean por inyección a alta presión, con lo cual se consigue una estructura sin juntas y muy resistente. En estas colecciones se aplica también una capa adicional de imprimación epoxi.

### MANTENIMIENTO

El aluminio requiere un mantenimiento sencillo, con agua y un detergente líquido Ph neutro. Las manchas persistentes se pueden eliminar con Aluminium Cleaner (p. 186). Si es necesario, se puede utilizar un cepillo suave para eliminar la suciedad de los poros. aluminium Protector (p. 186) crea una película invisible que evita la adherencia de la suciedad en la estructura.



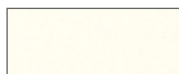

### INFORMATION

Stainless steel is an iron alloy in which the resistance to corrosion is increased by the addition of chrome, molybdenum and nickel. When exposed to air, a chromium oxide skin is formed spontaneously that protects the metal against rust. By powdercoating stainless steel, you can increase its corrosion resistance to the same level as that of aluminium. For its powdercoated stainless steel furniture Tribù uses 304L stainless steel that is ceramic blasted before it is powdercoated. Tribù always uses European, ultra-durable and scratch-resistant polyester powdercoating that guarantee a UV-resistance of 15 years.



### MAINTENANCE

Powdercoated stainless steel is easy to clean with clear water and a pH-neutral fluid detergent. Stubborn stains can be removed with Aluminium Cleaner (p. 186). If necessary, use a soft brush to remove the dirt from the pores. To protect the frame against the adhesion of dirt and to reduce fingerprints, aluminium Protector (p. 186) can be used which applies an invisible protective film.

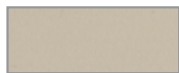

---

### INFORMACIÓN

El acero inoxidable es una aleación cuya resistencia a la corrosión se incrementa mediante la adición de cromo, molibdeno y níquel. El óxido de cromo, una dura capa cerámica que protege el metal contra la oxidación, se forma espontáneamente por exposición al aire. Al revestir el acero con una pintura en polvo, su resistencia a la corrosión se iguala a la del aluminio. Para el acero inoxidable pintado en polvo, Tribù utiliza acero 304L radiado previamente con gránulos cerámicos. Tribù utiliza siempre pinturas de poliéster en polvo europeas ultra-durable a los arañazos y con una resistencia a los rayos ultravioleta de 15 años.

### MANTENIMIENTO

El acero inoxidable pintado en polvo requiere un mantenimiento sencillo, con agua y un detergente líquido Ph neutro. Las manchas persistentes se pueden eliminar con Aluminium Cleaner (p. 186). Si es necesario, se puede utilizar un cepillo suave para eliminar la suciedad de los poros. aluminium Protector (p. 186) crea una película invisible que evita la adherencia de la suciedad en la estructura.



AMANU, DUNES, ELIO, HEXAGON, ILLUM, KOS, MOOD, NOMAD, PAVILION, PURE SOFA, ROOTS, SENJA, OTTO, TAIRU, T-TABLE, UKIYO & VIS À VIS



#### INFORMATION

Because Tribù makes no concessions when it comes to quality, we only use carefully selected, fully grown teak, which is harvested in accordance with the strictest environmental standards from the three highest quality Indonesian plantations in the East of Java. The local productions are checked all year round by subsidiary Tribù Asia, based in Semarang and led by a European management. Tribù designs its furniture in the way that the wood is used as efficiently as possible.

Teak is classed as the most premium wood on the planet and therefore the most suitable species for outdoor furniture. Beyond its beauty, teak possesses some natural properties that other woods don't have. It is extremely durable, stable, water and weather resistant. This is due to the high levels of natural oils which result in minimal moisture absorption, giving it great stability. Moreover, the wood is extremely resistant to fungi, as well as against parasite attacks and insects.

A tree is mature after 75 to 80 years. The trees are ringed, which means that the lower band of the bark is removed. The tree then loses most of its sap. About two years later it is felled and sawed up. Tribù selects each log based on its structure. Drying the wood is a very important phase and determines how it reacts later on. The time and speed of drying depends on the thickness of the material. Ideally the level of moisture lies between 8 and 12%.

#### MAINTENANCE

Teak left in its natural state, is virtually maintenance-free. It can be left outside all year round, surviving even the most extreme weather conditions. New teak will experience natural oil surfacing that appears like a "watermark" or irregular pattern of discoloration. These areas are part of the natural maturing process and can be removed with gentle washing with Teak Super Cleaner (p. 184).

Over time, untreated teak furniture which is exposed to sun and rain will turn silver grey. This process is cosmetic and does not harm the strength or quality of the wood.

To avoid the annual cleaning of the wood, you can apply Teak Sealer (p. 184). Teak Sealer contains UV protection to slow down the graying from the sun as well as a fungicide to prevent the growth of mold and mildew. Teak Sealer can be applied to new teak or old teak furniture after it has been cleaned. We recommend using Teak Super Cleaner (p. 184) to clean soiled furniture. If Teak Sealer is applied every season, a simple cleaning with water and a pH neutral soap will do for years. Teak Sealer is a sealer and is not the same as varnish. It is breathable, letting the natural oils escape without bubbling or peeling like varnish.

Teak Protector (p. 185) protects the wood against stains and green deposit, without colouring the wood. We recommend to apply it after each cleaning.

#### USE OF VARNISH AND OIL ON TEAK

Teak is protected by its own natural oils that migrate to the surface of the wood and make the wood virtually impervious to water. As such, the use of varnish and oil (especially linseed oil) on teak furniture is not recommended. Products such as varnish and polyurethane may peel and chip and require vigorous sanding to remove. Oiling teak does not prevent the wood from graying, and often results in mold and mildew growing on the furniture. Removing mold and mildew on the surface requires washing the furniture with bleach and soap followed by sanding. Tribù and authorities from the timber profession itself tend to advise against the use of teak oil.

#### OIL STAINS ON CUSHIONS

Because teak does not absorb water and is rich in natural oils and silicates, the weathering process includes oil surfacing. This teak oil can cause stains on cushions. Fabric stained by natural teak oil can be cleaned with soap and water or a special eucalyptus-based cleaner. Please be aware oil surfacing is a naturally repeating process that cannot be prevented.



---

AMANU, DUNES, ELIO, HEXAGON, ILLUM, KOS, MOOD, NOMAD, PAVILION, PURE SOFA, ROOTS, SENJA, OTTO, TAIRU, T-TABLE, UKIYO & VIS À VIS

---



### INFORMACIÓN

En cuestiones de calidad, Tribù no deja nada al azar, por lo que tan sólo utiliza árboles de teca adultos cuidadosamente seleccionados y cultivados respetando las normas de medio ambiente más estrictas y procedentes de las tres plantaciones de mejor calidad de Java Oriental. Las producciones locales son controladas durante todo el año por nuestra filial Tribù Asia, establecida en Semarang y dirigida por una administración europea. Tribù diseña su mobiliario con vistas a que la madera se utilice de la forma más eficiente posible para minimizar la cantidad de residuos.

La teca está considerada como la madera de mejor calidad del mundo y por tanto es la más adecuada para el mobiliario de exterior. Además de su belleza, la teca tiene varias propiedades naturales que otras maderas no tienen. Es extremadamente duradera, estable y resistente al agua y la intemperie, en parte, gracias a su alto nivel de aceites naturales, que limita al máximo la absorción de humedad y le aporta una alta estabilidad. Además, la madera de teca es extremadamente resistente a los hongos, los parásitos y los insectos.

El árbol alcanza la edad adulta a los 75 - 80 años. Los árboles se anillan, lo cual significa que se elimina la capa más inferior de la corteza. De esta forma, el árbol pierde la mayor parte de su savia. Alrededor de dos años más tarde, se corta y se sierra. Tribù selecciona cada lote según su estructura. El secado de la madera es una fase fundamental y determina su reacción posterior. El tiempo de secado depende del grosor del material. El nivel ideal de humedad se encuentra entre el 8 % y el 12 %.

### MANTENIMIENTO

La teca es una madera única y por su naturaleza apenas requiere mantenimiento. Los muebles de teca pueden permanecer en el exterior durante todo el año, incluso en las condiciones meteorológicas más extremas. En la madera de teca nueva, el aceite natural sale al exterior, por lo que puede presentar marcas de agua o irregularidades en el color. Este efecto forma parte del proceso natural de maduración y se puede eliminar limpiándola suavemente con Teak Super Cleaner (p. 184).

Con el transcurso del tiempo, y debido a la exposición al sol y la lluvia, la teca no tratada se tornará de color gris plata. Se trata de un proceso estético y no tiene influencia ninguna en la resistencia ni en la calidad de la madera. Para evitar la limpieza anual con Teak Super Cleaner se puede utilizar el Teak Sealer (p. 184). El Teak Sealer protege la madera de los rayos ultravioleta y evita que se ponga gris debido al sol. Además, es fungicida y previene la aparición de hongos y mildiu. Teak Sealer se puede utilizar en mobiliario de teca tanto nuevo como antiguo una vez limpio. Recomendamos utilizar Teak Super Cleaner (p. 184) en muebles muy sucios. Si se utiliza el Teak Sealer una vez al año, será suficiente una simple limpieza con agua y un jabón neutro durante años. Teak Sealer es un sellador, no un barniz. Es transpirable, de modo que los aceites naturales de la madera pueden salir al exterior sin formar burbujas ni zonas desconchadas.

Teak Protector (p. 185) protege la madera de las manchas y el moho sin dar color y es aconsejable aplicarlo después de cada limpieza.

### USO DE BARNIZ Y ACEITES EN LA MADERA DE TECA

La teca se protege con sus propios aceites naturales, que emergen a la superficie de la madera y la hacen impermeable. Se desaconseja el uso de barnices y aceites (especialmente el de linaza). Productos como el barniz y el poliuretano pueden descamarse y sólo se pueden retirar lijando fuerte la madera. Los aceites de la teca no evitan que la madera se ponga grisácea y suelen fomentar la aparición de hongos y mildiu. Para eliminarlos, se puede limpiar la zona afectada con un producto blanqueador y jabón, y después lijarla. Tribù y la industria del mueble aconsejan no aplicar aceites a la teca.

### MANCHAS DE TECA EN ALMOHADONES

Dado que la teca no absorbe la humedad y es rica en aceites naturales y silicatos, con el tiempo, el aceite emerge a la superficie. Este aceite puede provocar manchas en los almohadones que se pueden eliminar con jabón y agua o un limpiador especial a base de eucalipto. Tenga en cuenta que la aparición de aceite en la superficie de la teca es un proceso natural y repetitivo y no se puede evitar.





### INFORMATION

Tribù only uses high grade virgin polypropylene compound for the production of the Vintage and Branch collection. The mass dyed PP is made anti-static, anti-fungal, frost resistant and stain repellent by the addition of additives. Also, contact with salt or chlorine water causes no problems. A very high percentage of UV stabilizing additives guarantees extremely high colour fastness, even after a long exposure to sunlight. Sharp objects should be avoided as they may cause scratches.

### MAINTENANCE

Our synthetic furniture pieces are easy to maintain with clear water and a pH neutral soap. Stubborn stains can be removed with Synthetics Super Cleaner (p. 188). If necessary, use a soft brush to remove dirt from the pores. For extra protection we recommend Synthetics Protector (p. 188) or aluminium Protector (p. 186) which apply an invisible film and reduces the adhesion of dirt.

---

### INFORMACIÓN

Tribù utiliza solamente compuestos de polipropileno puro de alta calidad para las colecciones que contienen plástico. El polipropileno coloreado en masa es antiestático, antihongos, antihumedad y resistente a las manchas gracias a la adhesión de aditivos. También es resistente al contacto con el agua salada o clorada. Gracias a su alto porcentaje de aditivos estabilizadores de los rayos ultravioletas se consigue una estabilidad del color extremadamente alta, incluso después de una exposición prolongada al sol. Se aconseja evitar los objetos punzantes puesto que pueden provocar arañazos.

### MANTENIMIENTO

El plástico es fácil de limpiar con agua y un detergente líquido Ph neutro. Las manchas persistentes se pueden eliminar con Synthetics Super Cleaner (p. 188). Si es necesario, se puede utilizar un cepillo suave para eliminar la suciedad de los poros. Si se desea mayor protección, aconsejamos el uso de Synthetics Protector (p. 188) o aluminium Protector (p. 186), para crear una película invisible que evita la adherencia de la suciedad.





#### INFORMATION

Batyline® is a polyester fibre which is coated with solution dyed PVC and then woven. The fibres are then melted together to create an extremely stretch and tear-resistant fabric that keeps its shape perfectly. Apart from its exceptional mechanical strength, it has a high chemical resistance. The synthetic coating guarantees an extremely high weather and UV-resistance. The fact that no moisture is absorbed, results in rapid drying, maximum stain and mould-resistance and simple cleaning. The most important feature is its pliancy and optimal seating comfort.

Canatex® is the marriage between Batyline® and a natural fibre, hemp. The combination of the two leads to more subtle colours and a natural touch, leaving all the technological advantages of the product untouched.

#### MAINTENANCE

Batyline® is easy to clean with clear water and a pH-neutral soap. Stubborn stains can be removed with Synthetics Super Cleaner (p. 188). If necessary, use a soft brush to remove dirt from the pores. Do not use acid, alkaline or chlorinated products that can harm the hardware of your furniture.

For extra protection we recommend Synthetics Protector (p. 188) which applies an invisible film and reduces the adhesion of dirt.

#### INFORMACIÓN

Batyline® es un tejido de hilo de poliéster recubierto de PVC coloreado en masa. Los hilos se funden para crear un tejido altamente resistente a los desgarros y que mantiene la forma perfectamente. Además de su extraordinaria resistencia mecánica, Batyline® también presenta una alta resistencia química. La capa de pvc sintético garantiza una resistencia extrema a la intemperie y los rayos ultravioleta. Batyline® no absorbe la humedad, se seca muy rápido y es resistente a las manchas y los hongos. También es un material muy flexible, por lo que es muy cómodo y agradable.

Canatex® es una variante especial que combina Batyline® con fibras de cáñamo naturales. Esta combinación permite crear colores más sutiles y un aspecto y tacto más naturales manteniendo al mismo tiempo todas las ventajas tecnológicas del producto.

#### MANTENIMIENTO

Batyline® requiere un mantenimiento muy sencillo y se puede limpiar fácilmente con agua y un detergente líquido Ph neutro. Las manchas persistentes se pueden eliminar con Synthetics Super Cleaner (p. 188). Si es necesario, se puede utilizar un cepillo suave para eliminar la suciedad de los poros. No utilice productos ácidos, básicos ni clorurados que puedan deteriorar el herraje de su mobiliario.

Para una mayor protección, recomendamos el Synthetics Protector (p. 188) que aplica una película invisible que reduce la adherencia de la suciedad.



**INFORMATION**

Canax® is a unique combination of natural hemp and synthetic fibres. Unbreakable polyester fibres give strength and stability. PVC makes the Canax® stain repellent and resistant to outside influences, fungi, frost and UV radiation. The hemp finally, gives the material a surprisingly matte look and a natural touch, almost like leather. Canax® is also a CO2 positive product. As hemp is a natural product, differences in colour and structure may appear, giving the furniture - together with the hand weaving - a unique craft appearance, which cannot be regarded as a fault.

**MAINTENANCE**

Canax® requires hardly any maintenance and is easy to clean with clear water and a PH neutral soap. Stubborn stains and persistent green deposit can be removed with Synthetics Super Cleaner (p. 188). Use a soft brush to clean between the weave.

For extra protection we recommend Synthetics Protector (p. 188) which applies an invisible film and reduces the adhesion of dirt.

**INFORMACIÓN**

El Canax® es una combinación única de fibras de cáñamo e hilos sintéticos. Las fibras de poliéster irrompibles proporcionan fuerza y estabilidad. El PVC hace que el color del material no varíe y sea resistente a los hongos, las heladas y las manchas. La fibra de cáñamo proporciona un sorprendente aspecto mate y natural, casi comparable al cuero. Además, Canax® es un producto CO2 positivo. La fibra de cáñamo es un producto natural y por ello puede sufrir variaciones en el color y la estructura. Al estar tejido a mano proporciona a la pieza un aspecto único y artesanal, sus pequeñas variaciones no se han de ver como un defecto.

**MANTENIMIENTO**

Canax® requiere un mantenimiento muy sencillo y se puede limpiar fácilmente con agua y un detergente líquido Ph neutro. Las manchas persistentes se pueden eliminar con Synthetics Super Cleaner (p. 188). Puede utilizar un cepillo suave para eliminar la suciedad incrustada en el tejido.

Para una mayor protección, recomendamos el Synthetics Protector (p. 188) que aplica una película invisible que reduce la adherencia de la suciedad.



**INFORMATION**

Canax® straps are a unique combination of natural hemp and synthetic fibres. Unbreakable polyester fibres give strength and stability. PVC makes the straps stain repellent and resistant to outside influences, fungi, frost and UV radiation. The hemp finally, gives the material a surprisingly matte look and a natural touch. As hemp is a natural product, differences in colour and structure may appear, giving the furniture a unique craft appearance, which cannot be regarded as a fault.

**MAINTENANCE**

The Canax® straps require hardly any maintenance and are easy to clean with clear water and a pH neutral soap. Stubborn stains and persistent green deposit can be removed with Synthetics Super Cleaner (p. 188). Use a soft brush to clean between the weave.

For extra protection we recommend Synthetics Protector (p. 188) which applies an invisible film and reduces the adhesion of dirt.

**INFORMACIÓN**

El Canax® es una combinación única de fibras de cáñamo e hilos sintéticos. Las fibras de poliéster irrompibles proporcionan fuerza y estabilidad. El PVC hace que el color del material no varíe y sea resistente a los hongos, las heladas y las manchas. La fibra de cáñamo proporciona un sorprendente aspecto mate y natural. La fibra de cáñamo es un producto natural y por ello puede sufrir variaciones en el color y la estructura. Al estar tejido a mano proporciona a la pieza un aspecto único y artesanal, sus pequeñas variaciones no se han de ver como un defecto.

**MANTENIMIENTO**

Las cintas en tejido Canax® requieren un mantenimiento muy sencillo y se pueden limpiar fácilmente con agua y un detergente líquido Ph neutro. Las manchas persistentes se pueden eliminar con Synthetics Super Cleaner (p. 188). Puede utilizar un cepillo suave para eliminar la suciedad incrustada en el tejido.

Para una mayor protección, recomendamos el Synthetics Protector (p. 188) que aplica una película invisible que reduce la adherencia de la suciedad.

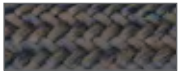

**INFORMATION**

Tricord® is a brand new composite material for which Tribù has exclusivity. It is a unique combination of nautical and synthetic fibres. The inside consists of unbreakable polyester that gives it strength and stability. The outside is a combination of nautical fibres that create a surprisingly soft touch and natural appearance. The composition of these nautical fibres (polyolefin) makes Tricord® completely resistant to outside influences: frost, water, fungi and UV-rays.

The furniture is hand woven - no two pieces are ever alike. The unique craft appearance is part and parcel of the charm of the product and cannot be regarded as a fault. The backs of the Mood and CTR collection can be purchased individually and easily replaced if necessary.

**MAINTENANCE**

Before use, we recommend to treat the Tricord® weave with Textile Protector (p. 189) which applies an invisible, dirt and water repellent film. The straps can be cleaned with clear water and a ph-neutral detergent or Synthetics Super Cleaner (p. 188). Allow the detergent to act for a while, then rinse abundantly with clean water. Drying may take a while on cloudy days.

After cleaning, treat with Textile Protector (p. 189). The cleaning will become easier and will require mainly rinsing with clean water.

**INFORMACIÓN**

El Tricord® es un material compuesto nuevo diseñado en exclusiva para Tribù. Se trata de una combinación única de fibras náuticas e hilos sintéticos. El interior está compuesto por fibras de poliéster irrompibles que aportan al tejido resistencia y estabilidad. El exterior es una combinación de fibras náuticas que aportan al material un aspecto y un tacto naturales. La composición de estas fibras náuticas (poliolefina) hace que el Tricord® sea resistente a todos los agentes exteriores: heladas, agua, hongos y rayos ultravioleta. Los muebles se tejen a mano, ninguna pieza es igual a otra. El aspecto único y artesanal que ello proporciona forma parte del encanto de este producto y no se ha de ver como un defecto. Los respaldos de la colección Mood y CTR se pueden adquirir por separado y son fáciles de sustituir en caso necesario.

**MANTENIMIENTO**

Antes de su uso, recomendamos aplicar Textile Protector (p. 189) a las cintas de Tricord® para incrementar su resistencia a las manchas y su impermeabilidad. Se puede limpiar con agua y un detergente líquido Ph neutro o con Synthetics Super Cleaner (p. 188). Es recomendable dejar actuar el detergente durante unos minutos.

A continuación, trate con el Textile Protector (p. 189), que tiene un efecto repelente de manchas y asegura que el tejido se seque más rápido. Esto hará que la limpieza sea más fácil y menos frecuente.



# TOSCA WEAVE

## TRENZA TOSCA

---

TOSCA



### INFORMATION

The extra-large weave that is used for the Tosca collection is made with a material that was developed exclusively by Tribù. A great deal of research went into the material, resulting in a unique product with a natural and soft appearance, that is nevertheless 100% weatherproof. An EPDM foam filling is over braided with a tubular, seamless cover of knitted textile and Tricord (polyolefin). The material is fungi-resistant, stain-repellent, does not fade and dries relatively quickly. It is 100% suitable for outdoor use in any environment. However, to minimize cleaning, we advise to use our covers when not using the furniture.

### MAINTENANCE

Rinse the braiding regularly with clean water. For intensive cleaning, use Synthetics Super Cleaner (p. 188). This cleaner also works perfectly for the powdercoated stainless steel frame. Always rinse the furniture with clean water after treatment with cleaning agents. Allow the braid to dry and treat with Textile Protector (p. 189). This will apply an invisible stain repellent film which enables the furniture to dry quicker. The cleaning will also become easier, less frequent and requires mainly rinsing with clean water.

---

### INFORMACIÓN

La trenza extra ancha empleada en la colección Tosca es un material desarrollado en exclusiva por Tribù. Se ha necesitado mucha investigación previa antes de dar con un material de apariencia suave y natural, pero 100 % resistente a los elementos climatológicos. Se recubre una base de espuma con una capa tubular y sin costuras de tejido y Tricord (poliolefina). El material es resistente al moho, a las manchas y a los rayos ultravioleta, y de secado relativamente rápido. Es apto para uso en exterior en cualquier entorno. Para minimizar la limpieza, recomendamos cubrir los muebles con fundas cuando no los utilice.

### MANTENIMIENTO

Limpie el tejido regularmente con agua. Las manchas persistentes se pueden eliminar con Synthetics Super Cleaner (p. 188). Este producto también se puede utilizar para limpiar la estructura de acero inoxidable pintada en polvo. Aclare siempre los muebles después con agua. Deje secar bien el tejido y después trátelo con Textile Protector (p. 189) para evitar la adherencia de suciedad y permitir que el tejido seque más rápido. Además, la limpieza será más fácil y menos frecuente.





### INFORMATION

The textilene straps of the Natal Alu Sofa consist of a coated polyester weave. The combination of PVC and polyester guarantees a lasting high tension and provides an excellent resistance to all weather conditions. The straps dry quickly and are stain repellent. A fungi-repellent treatment prevents the formation of mold.

### MAINTENANCE

The textilene straps are easy to clean with clear water and a pH-neutral soap. Stubborn stains can be removed with Synthetics Super Cleaner (p. 188). If necessary, use a soft brush to remove dirt between the straps. Do not use acid, alkaline or chlorinated products that can harm the hardware of your furniture.

For extra protection we recommend Synthetics Protector (p. 188) which applies an invisible film and reduces the adhesion of dirt.

---

### INFORMACIÓN

Las bandas de textileno de la colección Natal Alu Sofa están compuestas por un tejido de poliéster recubierto, igual que Batyline. La composición del material garantiza una tensión prolongada del asiento y una excelente resistencia a los elementos climatológicos. Las bandas no pierden el color, son resistentes a las manchas y de secado rápido. Un tratamiento fungicida previene la aparición de hongos debido a la humedad.

### MANTENIMIENTO

Las bandas de textileno se pueden limpiar fácilmente con agua y un detergente líquido Ph neutro. Para las manchas persistentes puede utilizar Synthetics Super Cleaner (p. 188). Para eliminar la suciedad incrustada en el tejido utilice un cepillo suave. No utilice sal ni productos clorurados que puedan deteriorar el herraje de su mobiliario.

Para una mayor protección, recomendamos el Synthetics Protector (p. 188) que aplica una película invisible que reduce la adherencia de la suciedad.





#### INFORMATION

Ceramic has been used for centuries for all kinds of purposes. With its unique characteristics it is the ideal material for outdoor table tops. Ceramic is UV-resistant, frost proof, extremely scratchproof and completely stain-repellent. The ceramic used by Tribù is coloured in the mass and guarantee years of carefree pleasure. The raw materials are selected very carefully by suppliers from Western and Southern Europe only. Every top is unique. For example, the Scisto colour may show subtle veins, but this is not the case for every top. The ceramic table tops are slightly bended so water can flow off.

#### MAINTENANCE

Ceramic is very easy to maintain with clear water and a pH-neutral soap. Stubborn stains can be removed with Ceramic & Lava Stone Cleaner (p. 187). To protect the ceramic, Ceramic & Lava Stone Protector (p. 187) can be used. This applies a highly water and soiling repellent coating, which also makes the surface brighter, smoother and easier to clean.

#### INFORMACIÓN

La cerámica se utiliza desde hace siglos para todo tipo de fines y es el material ideal para las planchas de las mesas de uso exterior. Es altamente resistente a las manchas, los ácidos, los arañazos, el fuego, la humedad y los rayos ultravioleta. La cerámica que Tribù utiliza está coloreada en masa y garantiza un disfrute duradero sin preocupaciones. La selección de las materias se realiza de forma muy escrupulosa por parte de proveedores la zona sur y occidental de Europa.

Cada tablero es único. Por ejemplo, la variante Scisto puede mostrar pequeñas vetas\*, pero no es así en todos los casos. Las planchas cerámicas para mesas están ligeramente curvadas para que el agua pueda caer.

#### MANTENIMIENTO

La cerámica requiere un mantenimiento sencillo, con agua y un detergente líquido Ph neutro. Las manchas persistentes se pueden eliminar con Ceramic & Lava Stone Cleaner (p. 187). Ceramic & Lava Stone Protector (p. 187) crea una película protectora invisible sobre la cerámica que la hace impermeable y evita la adherencia de la suciedad. La superficie queda más brillante, más lisa y más fácil de limpiar.





## INFORMATION

Our tables in lightened concrete do not contain gravel, like ordinary concrete, but a mix of quartz granulates and fibres, making the material a lot lighter. Nevertheless, it is very sturdy\* and durable. Frost and heat have no influence and the colouring in the mass ensures that your table will retain its original colour for a long time. Each furniture piece is hand-finished by an Italian craftsman, giving it a unique patina and a smooth surface texture.



However, lightened concrete is a natural product and sensitive to stains. Despite the fact that we treat our tables with a concrete conditioner that reduces stains and moisture absorption, some caution is required, as with natural stone and marble.

\*We recommend a maximum load of 22lb/10kg on the coffee table tops.

## MAINTENANCE

For daily cleaning, dip a soft, clean cloth in a solution of warm, clear water and a pH-neutral fluid detergent. Rinse thoroughly and let dry. Stains should be wiped off immediately, especially acidic substances (juice, coffee, red wine, balsamic vinegar,...) since they may cause permanent stains. Also bird droppings and leaves may cause permanent stains if not removed immediately. We recommend to use a protective cover if you are not using your table.

Oil, grease and wax stains can be removed by using Tribù Oil, Wax and Grease Remover (p. 190). Do not use corrosive or acidic detergents.

To protect your table, we recommend to use Tribù Lightened Concrete Conditioner (p. 190) regularly. However, this product does not protect against acidic substances. It can also be used for removing stains. Depending on the type of stain and its age, the stain can be completely removed or its intensity reduced.

Lightened concrete contains natural fibers that can surface over time due to temperature fluctuations, which could feel slightly unpleasant to the touch. If this happens, we recommend to lightly hand sand the table top with a sanding disc making circular movements until the surface feels smooth again.









### INFORMACIÓN

Nuestras mesas de hormigón aligerado no contienen grava, como el hormigón que se utiliza habitualmente, sino una mezcla de gránulos de cuarzo y fibras que lo hacen mucho más ligero. Sin embargo, es muy resistente\* y duradero. Las heladas y el calor no le afectan, y su coloreado en masa procura que la mesa conserve su color original de manera óptima. La superficie sedosa y los preciosos tonos, únicos en cada mesa, garantizan un aspecto elegante y sofisticado.



Aun así, el hormigón aligerado es un producto natural y sensible a las manchas. Aunque aplicamos a nuestras mesas un acondicionador de hormigón que reduce el efecto de las manchas y la absorción de humedad, se requiere cierta precaución, como con la piedra natural y el mármol. Le invitamos a repasar atentamente los siguientes consejos.

\*La carga máxima de las mesas auxiliares bajas es de 10 kg.

### MANTENIMIENTO

Limpie con agua y un detergente neutro suave, o con Lightened Concrete Conditioner de Tribù. Este producto también actúa como protector. Le recomendamos tratar la mesa periódicamente con este producto. Las manchas deben ser eliminadas inmediatamente, especialmente las sustancias ácidas (jugo de fruta, café, vino tinto, vinagre balsámico,...) para evitar manchas permanentes. También los excrementos y las hojas de los árboles pueden causar manchas permanentes si no se eliminan inmediatamente. Recomendamos utilizar una funda protectora si no se utiliza la mesa.

Las manchas de aceite, grasa y cera se pueden eliminar con el Oil, Wax and Grease Remover de Tribù (p. 190). No utilice detergentes corrosivos o ácidos.

Para proteger vuestra mesa, os aconsejamos utilizar regularmente el Lightened Concrete Conditioner de Tribù (p. 190). Sin embargo, este producto no protege contra las sustancias ácidas. También se puede utilizar para quitar las manchas. Según el tipo de mancha y su edad, la mancha puede ser eliminada completamente o su intensidad reducida.

El hormigón aligerado contiene fibras naturales que pueden aflorar con el tiempo debido a cambios de temperatura, y hacer que la parte superior de la mesa sea ligeramente desagradable al tacto. En caso de que esto ocurra, puede lijarse a mano suavemente la superficie con un disco lijador, realizando movimientos circulares continuos.





#### INFORMATION

Granite is an igneous rock that is formed deep below the earth's surface by compression. Because the pressure below the Earth's surface is so high, granite is immensely hard. After diamond, it is the strongest rock species on earth. Granite is little porous and has good scratch resistance. Germs and fungi have no chance. The name granite comes from the Latin 'granus', which means 'grain'. This 'granular' look is typical of granite. No two table tops will be ever alike. Tribù granite table tops have a 'leather touch' finish. This soft, brushed finish accentuates the natural colour of the material and gives a unique, soft touch.

#### MAINTENANCE

Granite can be cleaned with water and pH neutral soap. Granite Cleaner/Protector (p. 189) refreshes the gloss of the granite and makes it water and stain repellent. Do not use aggressive detergents as they attack the lime in the stone.

#### INFORMACIÓN

El granito es una roca magmática que se forma por compresión en la profundidad de la corteza terrestre. Dado que la presión bajo la corteza terrestre es tan alta, el granito es extremadamente duro. Se trata de la piedra más resistente después del diamante. El granito apenas es poroso y tiene una buena resistencia a los arañazos. No da cabida a las bacterias ni los hongos. El término granito procede del latín 'granus', que significa 'grano'. Este aspecto 'granulado' es típico del granito. Ningún sobre de mesa será igual a otro. Los sobres de mesa de granito Tribù tienen un acabado con aspecto 'cuero'. El acabado suave y cepillado acentúa el color natural del material y aporta un tacto suave.

#### MANTENIMIENTO

El granito se puede limpiar con agua y un detergente Ph neutro. Para una limpieza regular, recomendamos Granite Cleaner/Protector (p. 189). Además de limpiarlo, este producto devuelve el brillo al granito, lo hace impermeable y evita la adherencia de la suciedad. No utilice detergentes agresivos que puedan deteriorar la cal de la piedra.



# GLAZED LAVA STONE

## PIEDRA DE LAVA ESMALTADA

---

HEXAGON, NOX, SENJA, TAIRU & T-TABLE

---



### INFORMATION

Glazed lava is a unique and handcrafted material that expresses the natural aspect of lava stone. It offers the inherent strength of the volcanic stone combined with all the surface qualities associated with enamels. The density of the lava rock stone allows it to be used in one large piece. Once molten lava, the stone can withstand the very high temperatures used in the glazing process. Glazing makes sure the finished product is UV stable, impervious to water and resistant to heat, frost, chemicals and stains. It is very easy to maintain. Tribù chose for a subtle craquelé effect. As it is a natural product, you will find "aesthetic imperfections" that are just peculiar characteristic of both natural stone and handcrafted finishing. No table top in glazed lava stone will therefore be the same, making it so unique and attractive.

### MAINTENANCE

Glazed lava stone is easy to maintain with clean water and a pH neutral liquid detergent. Possible stains can be removed with Ceramic & Lava Stone Cleaner (p. 187). To protect the surface we recommend Ceramic & Lava Stone Protector (p. 187) which fills the micro pores so dirt particles won't attach to the surface and will be rain-washed.

---

### INFORMACIÓN

La piedra de lava esmaltada es un material único y tradicional que enfatiza el aspecto natural de la piedra de lava de una manera preciosa. Combina la fortaleza de la piedra de lava con las ventajas de los esmaltes. Gracias a la alta densidad de la piedra de lava, esta se puede utilizar en piezas grandes. Debido a que en algún momento fue lava fundida, la piedra puede soportar perfectamente las altas temperatura durante el proceso de esmaltado. La capa de esmalte hace que el material sea muy resistente al agua, al hielo, al calor, a las manchas y a la radiación UV. Tiene una alta resistencia a los productos químicos y prácticamente no requiere mantenimiento.

Tribù eligió un sutil efecto craquelado. Debido a que es un producto natural, sus "imperfecciones estéticas" son inherentes al material. Por lo tanto, ninguna encimera de piedra de lava esmaltada será igual. Esto es lo que hace que sea tan única y atractiva.

### MANTENIMIENTO

La piedra de lava esmaltada se puede limpiar fácilmente con agua limpia y con un detergente líquido con pH neutro. Las manchas se pueden eliminar con el producto Ceramic & Lava Stone Cleaner (p. 187). Para la protección recomendamos el uso del producto Ceramic & Lava Stone Protector (p. 187). Este producto llena los microporos del material, de manera que la suciedad no se puede adherir a la superficie y será arrastrada cuando caiga un chaparrón de lluvia.



**INFORMATION**

Travertine, a captivating natural stone, boasts unique characteristics and extensive applications. Formed by mineral deposits in natural springs, it features a distinctive porous texture that lends an elegant and rustic charm to both indoor and outdoor spaces. Its soft, neutral tones range from warm beige to cool gray, ensuring that every top is unique.

This originality is intensified by the stain-sensitive nature of the material. Oil, red wine, as well as other liquids and acids are absorbed, resulting in a permanent stain. This makes it a 'living thing' that, in time, displays subtle changes in colour and even surface structure. A product that becomes more and more unique with use, perfect for people who appreciate a table with personality.

**MAINTENANCE**

For daily cleaning, rub with a soft clean cloth immersed in a solution of hot, pure water and a pH-neutral detergent. Rinse thoroughly and leave to dry. Spills should be wiped up immediately, particularly acids, which can stain. Bird droppings and leaves can also stain if not removed immediately. We advise you to cover your table with a protective cover when not in use.

**INFORMACIÓN**

El travertino, una piedra natural cautivadora, ofrece características únicas y amplias aplicaciones. Formado por depósitos minerales en fuentes naturales, presenta una textura porosa distintiva que confiere un encanto elegante y rústico a espacios tanto interiores como exteriores. Sus suaves tonos neutros van del beige cálido al gris frío, lo cual garantiza que cada encimera sea única.

Esta originalidad se ve intensificada por la sensibilidad a las manchas de este material. El aceite, el vino tinto así como otros líquidos y ácidos son absorbidos, resultando en una mancha permanente. Esto lo convierte en un "elemento vivo" que, con el tiempo, presenta sutiles cambios de color e incluso de la estructura de la superficie. Un producto que se vuelve cada vez más único con el uso, perfecto para quienes valoran una mesa con personalidad.

**MANTENIMIENTO**

Para la limpieza diaria, frote con un paño suave y limpio sumergido en una solución de agua limpia caliente y un detergente de pH neutro. Aclare a fondo y deje secar. Limpie inmediatamente los derrames, sobre todo los ácidos, que pueden manchar. Los excrementos de pájaros y las hojas también pueden dejar manchas si no se eliminan inmediatamente. Le aconsejamos que cubra la mesa con una funda protectora cuando no la utilice.





## INFORMATION

Comprising natural stones or other aggregates in a binding agent like cement, terrazzo is a versatile and enduring material, fusing art with functionality. Tribù's innovative terrazzo-inspired products are made of natural stones set in lightened concrete with a blend of fibres which enhance durability, setting them apart from traditional terrazzo.

Although polished by hand, the composite exhibits a distinctive speckled appearance with open structure. As a result, our terrazzo-inspired material evolves over time, displaying subtle changes in colour and surface structure.

## MAINTENANCE

For daily cleaning, dip a soft, clean cloth in a solution of warm, clear water and a pH-neutral liquid detergent. Rinse thoroughly and let dry. Stains should be wiped off immediately, especially acidic substances (juice, coffee, red wine, balsamic vinegar,...) since they may cause permanent stains. Also bird droppings and leaves may cause permanent stains if not removed immediately. Oil, grease and wax stains can be removed by using Tribù Oil, Wax and Grease Remover (p. 190). Do not use corrosive or acidic detergents.

To protect your table, we recommend to use Tribù Lightened Concrete Conditioner (p. 190) regularly. However, this product does not protect against acidic substances. It can also be used for removing stains. Depending on the type of stain and its age, the stain can be completely removed or its intensity reduced.

## INFORMACIÓN

El terrazo, compuesto de piedras naturales u otros agregados en un aglutinante como el cemento, es un material versátil y duradero que combina el arte con la funcionalidad. Los innovadores productos de Tribù inspirados en el terrazo están hechos de piedras naturales fijadas en hormigón aligerado con una mezcla de fibras que aumentan su durabilidad, diferenciándolos del terrazo tradicional.

Aunque está pulido a mano, el compuesto ofrece un característico aspecto moteado con una estructura abierta. Por consiguiente, nuestro material inspirado en el terrazo evoluciona con el tiempo, mostrando cambios sutiles en el color y la estructura de la superficie.

## MANTENIMIENTO

Para la limpieza diaria, sumerja un paño suave y limpio en una solución de agua limpia templada y un detergente líquido de pH neutro. Aclare a fondo y deje secar. Las manchas deben limpiarse inmediatamente, especialmente las sustancias ácidas (zumo, café, vino tinto, vinagre balsámico,...) ya que pueden producir manchas permanentes. También los excrementos de pájaros y las hojas pueden causar manchas permanentes si no se eliminan inmediatamente.

Las manchas de aceite, grasa y cera pueden eliminarse utilizando Oil, Wax and Grease Remover de Tribù (p. 190). No utilice detergentes corrosivos o ácidos.

Para proteger su mesa, le recomendamos utilizar regularmente Lightened Concrete Conditioner de Tribù (p. 190). Sin embargo, este producto no protege contra las sustancias ácidas. También puede utilizarse para eliminar manchas. Según el tipo de mancha y su antigüedad, podrá eliminarse completamente o reducirse su intensidad.





#### INFORMATION

Illia Eckhard's goal was to uncover the true essence of the basket. He created Gobi after conducting an in-depth study of skill and artisanship, which we believe are the most authentic expressions of people's humanity and creativity. The beauty of the Gobi basket makes it a stellar example of Belgian dexterity and artisanship. Each one is made by skilled artisans using traditional weaving techniques.

The ropes are made from recycled plastic bottles, with an outer layer of recycled acrylic. The result is a unique product every time, with slight differences in colour and shape.

To maintain the original look and feel of your Gobi baskets, we recommend not leaving them out in the rain, as they take a long time to dry out. If your baskets do get wet, it's best to leave them to dry out fully in the open air, allowing all the moisture to evaporate. We have decided not to produce protective covers, as we believe it's better to bring the baskets indoors when it rains.

#### MAINTENANCE

Our synthetic furniture pieces are easy to maintain with clear water and a pH neutral soap. Stubborn stains can be removed with Synthetics Super Cleaner (p. 188). If necessary, use a soft brush to remove dirt from the pores. For extra protection we recommend Synthetics Protector (p. 188) which apply an invisible film and reduces the adhesion of dirt.

#### INFORMACIÓN

Illia Eckhard se propuso encontrar la verdadera esencia de la cesta. Así, creó Gobi después de realizar un profundo estudio de la artesanía y el trabajo manual, que creemos que son las expresiones más auténticas de la humanidad y la creatividad de las personas. La belleza de la cesta Gobi la convierte en un ejemplo fantástico de la destreza y la artesanía belgas. Cada una de ellas está hecha por hábiles artesanos que utilizan técnicas de tejido tradicionales.

Las cuerdas están hechas de botellas de plástico recicladas, con una capa exterior de acrílico reciclado. El resultado es un producto único, con ligeras diferencias de color y forma.

Para mantener el aspecto y el tacto originales de sus cestas Gobi, le recomendamos que no las deje al aire libre bajo la lluvia, ya que tardan mucho en secarse. Si sus cestas se mojan, es mejor dejarlas secar completamente al aire para que se evapore toda la humedad. Hemos decidido no fabricar fundas protectoras, ya que creemos que, en caso de lluvia, es mejor llevar las cestas al interior.

#### MANTENIMIENTO

Estos materiales son fáciles de limpiar con agua y un detergente líquido Ph neutro. Las manchas persistentes se pueden eliminar con Synthetics Super Cleaner (p. 188). Si es necesario, se puede utilizar un cepillo suave para eliminar la suciedad de los poros. Si se desea mayor protección, aconsejamos el uso de Synthetics Protector (p. 188) para crear una película invisible que evita la adherencia de la suciedad.





## INFORMATION

Vilex material is composed of solution-dyed PVC-coated polyester. This characteristic not only grants Vilex products outstanding UV resistance but also imparts effortless cleanability due to the non-absorbent nature of the yarns. These yarns facilitate rapid drying and exhibit stain-repelling qualities. Every item crafted from Vilex undergoes a manual weaving process, contributing to an artisanal aesthetic and ensuring the distinctiveness of each product.

## MAINTENANCE

Vacuum the material regularly to remove loose dirt. Clean with a garden hose and remove stubborn stains with Synthetics Super Cleaner (p. 188). To protect against stains, Synthetics Protector (p. 188) can be used which applies an invisible film.

## INFORMACIÓN

El material Vilex está compuesto de poliéster recubierto de PVC teñido en masa. Esta característica no solo confiere a los productos de Vilex una excelente resistencia a los rayos UV, sino que también facilita su limpieza sin esfuerzo gracias a la naturaleza no absorbente de los hilos. Estos hilos facilitan un secado rápido y presentan cualidades antimanchas. Cada artículo elaborado con Vilex se somete a un proceso de tejido manual, lo que contribuye a una estética artesanal y garantiza la singularidad de cada producto.

## MANTENIMIENTO

Aspire el material regularmente para eliminar la suciedad suelta. Limpie con una manguera de jardín y elimine las manchas resistentes con Synthetics Super Cleaner (p. 188). Para la protección contra las manchas, se puede utilizar Synthetics Protector (p. 188) que crea una película invisible.





#### INFORMATION

In the world of metals, brass is a distinctive element that has enriched our lives for centuries. Being an alloy of copper and zinc, it is highly malleable and therefore remarkably versatile. Its frequent use in the marine industry also underlines its sustainable quality.

But one of its captivating charms is its capacity to transform over time. When encountering the elements of its surroundings like air, moisture and various environmental factors, a chemical reaction leads to the formation of a thin outer layer, known as patina.

The intrinsic qualities and warm aesthetics of the brass make it the ideal material for our beautifully crafted hardware, detailing the table top and discreetly conjoining multiple SURO dining tables.

#### MAINTENANCE

Brass is easy to clean with clear, fresh water and a pH-neutral liquid detergent. Always use a soft, clean cloth. Over time, brass will develop a sophisticated patina, ranging from greens and blues to a warm brown.

Substances, especially salty and acidic ones like juice, coffee, red wine, balsamic vinegar, bird droppings and leaves, leave no stains but do influence the nuances of the brass' surface. For minimal impact, immediately wipe off all substances.

When cleaning, please avoid intense rubbing to maintain the corroded, matte appearance. Once the brass acquires a shiny glow, the only way to recover its elegantly aged appearance, is to be patient.

#### INFORMACIÓN

En el mundo de los metales, el latón es un elemento distintivo que ha enriquecido nuestras vidas durante siglos. Al tratarse de una aleación de cobre y zinc, es muy maleable y, por lo tanto, notablemente versátil. Su uso frecuente en la industria náutica también demuestra sus cualidades sostenibles.

Pero uno de sus cautivadores encantos es su capacidad para transformarse con el tiempo. Al entrar en contacto con los elementos de su entorno como el aire, la humedad y diversos factores ambientales, una reacción química lleva a la formación de una fina capa exterior, conocida como pátina.

Las cualidades intrínsecas y la cálida estética del latón hacen que sea el material ideal para nuestros bellos herrajes, que detallan la superficie de la mesa y unen discretamente varias mesas de comedor SURO.

#### MANTENIMIENTO

El latón es fácil de limpiar con agua limpia y un detergente líquido de pH neutro. Utilice siempre un paño suave y limpio.

Con el tiempo, el latón desarrollará una pátina sofisticada que va desde tonos verdes y azules hasta un marrón cálido. Las sustancias, especialmente las saladas y ácidas como el zumo, el café, el vino tinto, el vinagre balsámico, los excrementos de pájaros y las hojas no dejan manchas pero sí influyen en los matices de la superficie del latón. Para minimizar el impacto, limpie inmediatamente todas las sustancias.

Al limpiarlo, evite frotarlo intensamente para mantener el aspecto corroído y mate. Una vez que el latón adquiere un brillo resplandeciente, la única manera de recobrar su aspecto elegantemente envejecido es tener paciencia.





## INFORMATION

Trizo, made from HDPE material, is a sturdy water- and mold-resistant material suitable for various environments. This material is colorfast and mass-colored, making it perfect for outdoor use.



## MAINTENANCE

Trizo is easy to maintain. To remove stains, use warm, clean water and a pH neutral liquid cleaner or Synthetics Super Cleaner (p. 188). Gently buffing can help with minor scratches, so be sure not to use harsh abrasives. Using a cover can provide extra protection for the material and reduce the number of necessary maintenance sessions. For additional protection, we recommend the Synthetic Protector (p. 188), which forms an invisible layer that repels dirt.

---

## INFORMACIÓN

El trizo, fabricado con polietileno de alta densidad (HDPE), es un material sólido, resistente al agua y al moho, y apropiado para diversos entornos. Este material coloreado en masa no pierde su color, por lo que resulta perfecto para su uso en exteriores.

## MANTENIMIENTO

El trizo es fácil de mantener. Para eliminar las manchas, utilice agua limpia tibia y un limpiador líquido de pH neutro o Synthetics Super Cleaner (p. 188). Pulir suavemente puede ayudar a eliminar pequeños arañazos, así que procure no utilizar abrasivos fuertes. El uso de una funda puede proporcionar una protección adicional al material y reducir el número de sesiones de mantenimiento necesarias. Para una protección adicional recomendamos Synthetic Protector (p. 188), que forma una capa invisible repelente de la suciedad.





### INFORMATION

Tribù outdoor rugs are the only outdoor rugs on the market that are made of 100% solution dyed PVC coated polyester. This gives them not only an excellent UV resistance - they are also very easy to clean because the yarns do not absorb water. They dry quickly and are stain repellent. All rugs are hand woven which results in an artisanal look and makes each rug unique.

### MAINTENANCE

Vacuum the rug regularly to remove loose dirt. Clean with a garden hose or even a high pressure cleaner. Stubborn stains can be removed with Synthetics Super Cleaner (p. 188). To protect the rug against stains, Synthetics Protector (p. 188) can be used which applies an invisible film.

---

### INFORMACIÓN

Las alfombras de exterior de Tribù son las únicas alfombras de exterior en el mercado que están fabricadas al 100 % en poliéster recubierto de PVC coloreado en masa. Ello no sólo aporta una excelente resistencia a los rayos ultravioleta, sino que también facilita su limpieza porque las fibras no absorben el agua. Se secan rápido y son resistentes a las manchas. Todas las alfombras se tejen a mano, por lo que tienen un aspecto artesanal y cada una es única.

### MANTENIMIENTO

Aspire la alfombra regularmente para eliminar la suciedad suelta. Límpiela con una manguera o incluso con un limpiador de alta presión. Las manchas persistentes se pueden eliminar con Synthetics Super Cleaner (p. 188). Synthetics Protector (p. 188) protege la alfombra de las manchas creando una película invisible que evita la adherencia de la suciedad.





## INFORMATION

The Monsieur Tricot outdoor lamps are made of a sphere in PMMA thermoplastic with a removable hand crocheted or knitted polypropylene cover.

### Standing lamps

- Lamp
  - Dimmable LED, 9-12.6 Volt, Kelvin 2.129
  - 12 hours operational when burning at 100%
- Charging
  - Rechargeable battery
  - Power adaptor with USB-slot, cable included
  - 5 hours of charging time
- Control
  - On/off switch
  - Tribu Monsieur Tricot app (available for free in App Store or Google Play)
- Extra
  - Ceiling hook included to turn your standing lamp into a hanging version

### Hanging lamps

- Lamp
  - E27/E26 fitting with dimmable LED filament bulb included, Kelvin 2200
  - Connect to local power grid, 220-240 volt.
  - 5 meter cable, mounting bracket, ceiling canopy and wire connector clamps included
  - Please contact a local professional to install a hanging Monsieur Tricot lamp
- Control
  - Use an already available switch or have a local professional install a new switch. Switches cannot be purchased from Tribu

### Certificates

- CE (EU + UK), RoHS 2.0 (EU), FCC (USA), IC (Canada), SAA (Australia & New Zealand), RCM (Australia & New Zealand, only for standing lamps), MOC (Israel)
- IK08
- IP65

### MAINTENANCE

The knitted cover can easily be removed to be cleaned in a washing machine at 40° (synthetic washing program). Let dry in open air, certainly not in the dryer. Extend the Lebonnet braiding well before drying. Stubborn stains can be removed with Synthetics Super Cleaner (p. 188). Use a microfiber cleaning cloth to clean the lamp. Do not use a scourer, this causes scratches and damages the surface.





### INFORMACIÓN

Las lámparas de exterior Monsieur Tricot son de plástico PMMA con una funda de polipropileno a ganchillo. Las fundas se tejen a mano.

#### Lámparas de pie

- Lámpara
  - Lámpara led regulable, 9-12.6 voltios, Kelvin 2.129
  - Funciona durante 12 horas si el regulador está al 100%
- Carga
  - Batería recargable
  - Adaptador de corriente con conector USB, cable incluido
  - Tiempo de carga de 5 horas
- Control
  - Interruptor de encendido/apagado
  - Aplicación Tribù Monsieur Tricot (descarga gratuita en la Apple store o en Google Play)
- Extra
  - Incluido gancho de techo, para transformar su lámpara de pie en una lámpara colgante

#### Lámparas colgantes

- Lámpara
  - Adaptador E26/E27 con bombilla led incluida, Kelvin 2200
  - Conectar a la red eléctrica, 220-240 voltios.
  - Cable de 5 metros, soporte de montaje, soporte de techo y abrazaderas de conexión de cables incluidos.
  - Póngase en contacto con un profesional local para instalar una lámpara colgante Monsieur Tricot
- Control
  - Use un interruptor ya disponible o haga que un profesional local instale un interruptor nuevo. Los interruptores no se pueden comprar en Tribù.

#### Certificados:

- CE (UE + RU), RoHS 2.0 (UE), FCC (EE.UU.), IC (Canadá), SAA (Australia y Nueva Zelanda), RCM (Australia y Nueva Zelanda, non para las lámparas colgantes) IMOC (Israel).
- IK08
- IP65

#### MANTENIMIENTO

La funda tejida se puede quitar fácilmente para lavarla en la lavadora a 40° (programa de lavado sintético). Deje que se seque al aire libre, nunca la meta en la secadora. Tire bien del tejido Lebonnet antes de colgar la funda para que se seque. Las manchas persistentes se pueden eliminar con Synthetics Super Cleaner (p. 188). Use un paño de microfibra para limpiar la estructura de la lámpara. No utilice una esponja abrasiva, ya que podría rayar y dañar la superficie.













#### TEAK SUPER CLEANER - D9914 - 500 ml

Cleaner for regular or intensive cleaning.

1. First moisten the furniture with clear water.
2. Shake the Teak Cleaner well before use.
3. Apply Teak Cleaner with a soft cloth and allow to soak for 3 minutes.
4. Brush the furniture clean with the soft scrubbing pad in the direction of the grain.
5. Rinse well with clear water.

Para una limpieza normal o a fondo.

1. Humedecer primero el mueble con agua.
2. Agitar el envase de Teak Cleaner antes de usarlo.
3. Aplique Teak Cleaner con un paño y deje actuar durante 3 minutos.
4. Frote el mueble con un estropajo suave en la dirección de la veta de la madera.
5. Aclare bien el mueble con agua.



#### TEAK SEALER NATURAL - D9959 - 1000 ml

When Teak Sealer is applied every season, a labour-intensive cleaning with Teak Cleaner will not be necessary for many years. A simple cleaning with water and ph-neutral soap will do.

1. Allow new teak to weather for 1 to 2 weeks before applying Teak Sealer.
2. Clean soiled teak with Teak Cleaner or Teak Super Cleaner and leave to dry until the wood is completely dry.
3. Stir the Teak Sealer well and keep mixing throughout the application process.
4. Apply to the teak using a microfiber cloth, synthetic sponge or plants spray in the direction of the grain. Wipe any excess off with a microfiber cloth.
5. Leave to dry for 1 hour and apply a second coat.
6. Wipe over the second coat with a clean cloth.
7. The teak should be dry to the touch in 1 hour and ready for use the next day.

Cuando el Teak Sealer se aplica cada temporada, una limpieza intensiva con Teak Cleaner no será necesario durante muchos años. Una limpieza simple con agua y jabón neutral pH es suficiente.

1. Permita que la teca nueva se desgaste a la intemperie durante 1 a 2 semanas antes de aplicar el Teak Sealer.
2. Limpie la teca sucia con Teak Cleaner o Teak Super Cleaner y deje secar hasta que la madera esté completamente seca.
3. Agite bien el Teak Sealer y continúe mezclando durante todo el proceso de aplicación.
4. Aplicar la teca con un paño de microfibra, una esponja sintética o un pulverizador para plantas en la dirección del grano. Limpie cualquier exceso con un paño de microfibra.
5. Dejar secar durante 1 hora y aplicar una segunda capa.
6. Limpie la segunda capa con un paño limpio.
7. La teca debe estar seca al tacto en 1 hora y lista para el uso al día siguiente.



#### TEAK PROTECTOR GREY COLOUR - D9912 - 500 ml

Protects the teak against stains and green deposit. Doesn't colour the grey patina

1. New teak: leave your new furniture outside during a few weeks until they get a pale colour.
2. Old, grey teak: clean the teak first with Teak Cleaner. If the cleaned wood feels rough, sand slightly before using the Teak Protector.
3. Make sure that the teak is 100% dry and free of dust.
4. Shake the bottle for at least one minute. Apply with the soft and lint-free cloth and allow to soak in the teak.
5. Allow to dry for 4 hours, then apply a second layer.
6. Let the teak dry for 24 hours before exposing it to moisture.

Protege la teca de las manchas y el moho.

1. Teca nueva: deje los muebles varias semanas en el exterior para que tomen un color amarillo pálido.
2. Teca antigua, gris oscuro: limpie primero la teca con Teak Cleaner. Si tiene un tacto áspero, líjela suavemente.
3. Asegúrese de que la teca está totalmente seca y sin polvo.
4. Agite bien el envase de Teak Protector durante al menos un minuto antes de utilizarlo. Aplique una capa con un paño suave y sin pelusas. Deje actuar.
5. Espere 4 horas y aplique una segunda capa.
6. Deje secar la teca durante 24 horas antes de colocarla en el exterior.





#### ALUMINIUM CLEANER - D9952 - 500 ml

Cleans powdercoated aluminium and powdercoated stainless steel.

1. Rinse the furniture with clear water to eliminate loose dirt.
2. Spray the Aluminium Cleaner on the surface and let it rest.
3. In case of stubborn stains use a brush to remove the dirt from the pores.
4. Rinse with clear water and remove the dirt with a clean, moist cloth.
5. Dry with a microfiber cloth. Don't leave the surface to dry in full sun, this can leave white traces behind.

Limpia el aluminio y el acero inoxidable pintados en polvo.

1. Pulverice con Aluminium Cleaner desde abajo hacia arriba sobre toda la superficie y deje actuar.
2. Utilice un cepillo para las manchas persistentes y para eliminar la suciedad de los poros.
3. Aclare y/o retire la suciedad con un paño limpio.
4. No dejar secar al sol directo (puede dejar marcas blancas).
5. Para superficies delicadas, hacer una prueba en una zona no visible.



#### ALUMINIUM PROTECTOR - D9931

Reduces the adhesion of dirt and fingerprints.

1. Shake well before use.
2. Spray onto a clean microfiber cloth and rub on the surface with circular movements.
3. Use a clean, dry microfiber cloth and spread well.

Reduce drásticamente la adherencia de la suciedad y las huellas dactilares.

1. Agitar bien antes de usar.
2. Pulverizar sobre un paño de microfibra limpio y aplicar suavemente.
3. Extienda bien el producto con un paño de microfibra limpio y seco.



#### CERAMIC & LAVA STONE CLEANER - D9938 - 500 ml

Removes local stains.

1. Shake well before use.
2. Spray the surface with the spray and leave for a while.
3. Rub to dry with a clean microfiber cloth and polish with a dry cloth.

Elimina las manchas localizadas persistentes.

1. Agitar bien antes de usar.
2. Pulverizar la superficie con el spray en espuma y dejar actuar unos instantes.
3. Secar con un paño limpio y sin pelusas y volver a frotar con un paño seco.



#### CERAMIC & LAVA STONE PROTECTOR - D9955 - 100 ml

Applies an invisible, dirt repellent coating.

1. Clean the surface with Glass & Ceramic Cleaner.
2. It is essential that the surface is completely clean, dust free and dry before applying the Ceramic Protector.
3. Moisten a microfiber cloth with the Ceramic Protector and apply a layer to the surface, ensuring full and even coverage by fast circular movements.
4. Allow the newly coated surface to dry for a few minutes and then polish the surface with a clean microfiber cloth.

Protege la superficie con una capa transparente que repele la suciedad.

1. Limpie la superficie a fondo con Glass&Ceramic Cleaner D9938 y aclárela con agua limpia. Es importante que la superficie esté limpia, seca y sin polvo.
2. Empape un paño de microfibra con Ceramic Protector D9955 y aplique una capa uniforme mediante movimientos rápidos y circulares, que cubra más de la mitad de la superficie.
3. Continúe frotando la superficie hasta que el paño quede prácticamente seco.
4. Deje secar durante al menos 1 minuto (óptimo 5 minutos) y encere la superficie con un paño de microfibra limpio.





#### SYNTHETICS SUPER CLEANER - D9922 - 500 ml

Cleans stubborn stains from synthetic materials, Canax®, CTR; Elio, Mood, Tosca weave and Batyline®.

1. Rinse the furniture with clear water to eliminate loose dirt.
2. Spray the Synthetics Super Cleaner on the surface and let it soak.
3. In case of stubborn stains use a brush to remove the dirt from the pores.
4. Rinse with clear water and remove the dirt with a clean, moist cloth.
5. Dry with a microfiber cloth. Don't leave the surface to dry in full sun, this can leave white traces behind.

Elimina las manchas persistentes de materiales sintéticos, Canax®, trenza Tosca y Batyline®.

1. Pulverice con Synthetics Super Cleaner desde abajo hacia arriba sobre toda la superficie y deje actuar.
2. Utilice un cepillo para las manchas persistentes y para eliminar la suciedad de los poros.
3. Aclare y/o retire la suciedad con un paño limpio.
4. No dejar secar al sol directo (puede dejar marcas blancas).
5. Para superficies delicadas, hacer una prueba en una zona no visible.



#### SYNTHETICS PROTECTOR - D9921 - 500 ml

Applies an invisible film and protects against the adhesion of dirt. Suitable for synthetic materials, Canax® and Batyline®.

1. First clean your furniture with Synthetics Cleaner.
2. Shake the bottle well during at least one minute.
3. Apply a thin layer with a clean, dry and lint-free cloth.
4. Buff to shine with a soft, clean and dry cloth.

Protege contra la adhesión de suciedad. Adecuado para materiales sintéticos, Canax®, trenza Tosca y Batyline®.

1. Limpie primero sus muebles con Synthetics Cleaner.
2. Agite bien el envase de Synthetics Protector durante al menos un minuto antes de utilizarlo.
3. Aplique una capa fina con un paño suave y limpio.
4. Se formará una capa mate. Límpiela con un paño seco y limpio hasta que la superficie quede brillante.



#### TEXTILE PROTECTOR - D9924 - 400 ml

Makes fabric and weaves water and stain repellent.

1. Shake well before use.
2. Hold the spray can upright at a distance of approximately 30cm and vaporise in equal layers that slightly overlap each other.
3. Leave to dry.
4. For an optimal protection, after each cleaning, we recommend to use Textile Protector.

Crea una capa impermeable y evita la adherencia de la suciedad.

1. Agitar bien el envase.
2. Pulverizar en franjas que se vayan superponiendo ligeramente. Mantener el envase en posición vertical y pulverizar a +/- 30 cm de distancia.
3. Deje secar bien.
4. Para conseguir una protección óptima, recomendamos utilizar Textile Protector después de cada limpieza.



#### GRANITE CLEANER/PROTECTOR - D9961 - 500 ml

Cleans, maintains and protects granite surfaces.

1. Shake before use, then open the spray valve.
2. Spray the surface in an evenly way.
3. Spread and polish with a microfiber cloth until no more streaks or veil is visible.

Limpia y protege las superficies de granito

1. Agitar antes de usar, luego abra la válvula de pulverización
2. Rociar la superficie de manera uniforme
3. Corre y pula con un paño de microfibra hasta que no haya más rayas o velo visible.



**LIGHTENED CONCRETE CARE SET - D9964**

A complete set to take care of tables in lightened concrete.

- 1 Lightened Concrete Conditioner
- 1 Oil, wax & Grease Remover
- 1 sanding disc
- 1 brush
- 1 microfiber cloth

Un set completo para el mantenimiento de mesas en hormigón aligerado.

- 1 Lightened Concrete Conditioner
- 1 Oil, Wax & Grease Remover
- 1 disco lijador
- 1 cepillo
- 1 paño de microfibra

**LIGHTENED CONCRETE CONDITIONER – D9962 – 500ml**

Cleans surfaces in lightened concrete and protects against stains.

1. Wash the surface with clean water first and allow it to dry completely.
2. Shake before use, open the spray valve and spray lightly in an evenly way over the cooled surface.
3. Rub in with a clean, dry microfibre cloth with a circular motion or use a soft brush.
4. After approx. 10 minutes, remove the excess product with a clean, dry microfibre cloth until no more streaks or veil are visible.

Limpia las superficies de hormigón aligerado y protege contra las manchas.

1. Primero, limpie la superficie con agua limpia y déjela secar completamente.
2. Agite el envase antes de usar, abra la válvula de pulverización y aplique el producto de manera uniforme por toda la superficie enfriada.
3. Frote el producto con una bayeta de microfibra limpio y seco en movimientos circulares o use un cepillo.
4. Una vez transcurridos alrededor de 10 minutos, retire el exceso de producto con una bayeta de microfibra limpia y seca hasta que no queden rayas o veladuras.

**OIL, WAX & GREASE REMOVER – D9963 – 250ml**

A creamy paste that removes stains on lightened concrete caused by oil, grease or candle wax.

1. Wash the surface with clean water first to remove any loose dirt and make sure it is completely dry before you apply the product.
2. Apply a layer of paste, approx. 1 mm thick, evenly over the stain using a spatula or brush and leave the paste to soak in. Apply in open air during daytime and dry weather only.
3. After drying for approx. 30-60 minutes, brush off the paste. Repeat this process for stubborn or old stains.
4. Rinse the furniture with clean water and let it dry.
5. For optimal protecting against stains, treat the surface with Tribù Lightened Concrete Conditioner.

Una pasta cremosa que elimina las manchas del hormigón aligerado causadas por aceite, grasa o cera de velas.

1. Primero, limpie el mueble con agua limpia para eliminar la suciedad suelta y asegúrese de que esté completamente seco antes de usar el producto.
2. Aplique la pasta sobre la mancha de manera uniforme creando una capa de 1 mm de espesor con la ayuda de una espátula o una brocha y deje actuar. Aplicar sólo durante el día al aire libre y cuando esté seco.
3. Retire la pasta con la brocha una vez transcurrido un tiempo de secado de aproximadamente 30-60 minutos. En caso de manchas intensas o antiguas se puede repetir el proceso.
4. Aclare la superficie con agua limpia y deje secar.
5. Para una protección óptima contra las manchas, trate el hormigón con Lightened Concrete Conditioner.



### INOX SUPER CLEANER (CB & EP) - D9918 - 250 ml

Intensive cleaner for in-depth cleaning.

1. Rinse the furniture with clear water and let it dry.
2. Shake the bottle well.
3. Apply the cleaner undiluted by dabbing by means of a damp sponge or pad. Apply in the rolling direction of the surface to be treated. Leave to act.
4. Remove the residue carefully with a damp cloth (be careful, loose dirt or oxide may cause minor scratches).
5. Rinse abundantly with clear water.

Limpiador intensivo para la suciedad incrustada.

1. Enjuagar el mueble con agua clara.
2. Agitar bien la botella.
3. Aplique el limpiador sin diluir con una esponja húmeda en la dirección de la veta del material o en la dirección del cepillado o pulido de la superficie.
4. Elimine los residuos cuidadosamente con agua o un paño húmedo (atención: la suciedad y/o los óxidos que se van desprendiendo pueden provocar arañazos superficiales). Frote sin presionar para evitar que la suciedad vuelva a introducirse en los poros.
5. Aclarar abundantemente con agua limpia.





# PACKING LIST

LISTA DE EMBALAJES

ARTICLE NR.	ARTICLE	BOX. CONTENT	NR. OF BOXES	BOX DIM. (LXDXH)	VOLUME	GROSS WEIGHT BOX
				CM IN		
<b>AMANU</b>						
02618-10	Armchair		1	67x63x88cm 26.5x24.75x34.75"	0.4 14.1	11.5 25.4
02612-10	Lounge Chair		1	79x95x110cm 31x37.5x43.25"	0.8 28.3	10.5 23.2
02652-xx	Dining table 290 cm		3			
W2650	Teak - Only Legs - set of 2	2	1	193x82x10cm 76x32.25x4"	0.16 5.59	25.00 55.1
W2652	Teak frame - 2926 mm	1	1	296x100x10cm 116.5x39.25x4"	0.30 10.45	52.00 114.7
S2654-C*	Base Tiles	8	1	100x31x4cm 39.25x12.25x1.5"	0.01 0.44	8.00 17.6
S2653-C*	Corner Tiles	2	1	100x31x4cm 39.25x12.25x1.5"	0.01 0.44	8.00 17.6
02654-xx	Dining table 350 cm		3			
W2651	Teak - Only Legs - set of 2	2	1	193x82x10cm 76x32.25x4"	0.16 5.59	25.00 55.1
W2654	Teak frame - 3512 mm	1	1	354x100x10cm 139.25x39.25x4"	0.35 12.50	63.00 138.9
S2654-C*	Base Tiles	10	1	100x31x4cm 39.25x12.25x1.5"	0.01 0.44	8.00 17.6
S2653-C*	Corner Tiles	2	1	100x31x4cm 39.25x12.25x1.5"	0.01 0.44	8.00 17.6
<b>BRANCH</b>						
07610-xx-xx	Side chair	2	1	61x64x90cm 24x25.25x35.5"	0.4 14.1	3.7 8.2
07618-xx-xx	Armchair	2	1	65x64x92cm 25.5x25.25x36.25"	0.4 14.1	4.2 9.3
07640-xx-xx	Lounger	1	1	218x82x40cm 85.75x32.25x15.75"	0.7 24.7	29 63.9
07660-xx-xx	Bistro table round dia 80cm	1	2/3*			
A7660-xx	Alu top dia 80cm	1		90x88x14cm 35.5x34.75x5.5"	0.11 3.92	15.30 33.7
W7660	Teak top dia 80cm	1		85x85x8cm 33.5x33.5x3.25"	0.06 2.04	8.00 17.6
S7660	Granite top dia 80cm	1		88x86x7cm 34.75x33.75x2.75"	0.05 1.87	27.55 60.7
A7660CN-xxSET	Legs (set of 3pcs)	1		78x52x24cm 30.75x20.5x9.5"	0.10 3.44	6.20 13.7
A7660CR-xx	Cross (only for teak & granite top)*	1		30x27x8cm 11.75x10.75x3.25"	0.01 0.23	0.60 1.3
07662-xx-xx	Bistro table round dia 125 cm		2			
A7662-xx	Alu top dia 125cm	1		131x131x8cm 51.5x51.5x3.25"	0.14 4.85	33.50 73.9
W7662	Teak top dia 125cm	1		134x134x7cm 52.75x52.75x2.75"	0.13 4.44	25.50 56.2
S7662	Granite top dia 125cm	1		134x134x7cm 52.75x52.75x2.75"	0.13 4.44	82.00 180.8
A7662CN-xxSET	Legs + Cross	1		98x98x17cm 38.5x38.5x6.75"	0.16 5.77	12.85 28.3



# PACKING LIST

## LISTA DE EMBALAJES

ARTICLE NR.	ARTICLE	BOX CONTENT	NR. OF BOXES	BOX DIM. (LXDXH)		VOLUME	GROSS WEIGHT BOX
				CM	IN		
				M <sup>3</sup>	FT <sup>3</sup>	KG	LB
07671-xx-xx	Bistro table square 80x80cm		2/3*				
A7671-xx	Alu top 80x80cm	1		88x88x15cm 34.75x34.75x6"	0.12 4.10	17.85 39.4	
W7671	Teak top 80x80cm	1		85x85x8cm 33.5x33.5x3.25"	0.06 2.04	9.00 19.8	
S7671-xx	Granite top 80x80cm	1		87x87x7cm 34.25x34.25x2.75"	0.05 1.87	34.00 75.0	
A7670CN-xxSET	Legs (set of 4pcs)	1		78x52x24cm 30.75x20.5x9.5"	0.10 3.44	7.60 16.8	
A7671CR-xx	Cross (only for teak & granite top)*	1		17x19x6cm 6.75x7.5x2.25"	0.00 0.07	0.30 0.7	
07670-xx-xx	Bistro table square 90x90cm		2/3*				
A7670-xx	Alu top 90x90cm	1		98x100x14cm 38.5x39.25x5.5"	0.14 4.85	21.85 48.2	
W7670	Teak top 90x90cm	1		95x95x8cm 37.5x37.5x3.25"	0.07 2.55	12.00 26.5	
S7670-00	Granite top 90x90cm	1		98x98x6cm 38.5x38.5x2.25"	0.06 2.03	45.55 100.4	
A7670CN-xxSET	Legs (set of 4pcs)	1		78x52x24cm 30.75x20.5x9.5"	0.10 3.44	7.60 16.8	
A7670CR-xx	Cross (only for teak & granite top)	1		25x25x8cm 9.75x9.75x3.25"	0.01 0.18	0.60 1.3	
07652-xx-xx	Dining table 210x98cm		2				
A7652-xx	Alu top 210x98cm	1		219x107x15cm 86.25x42.25x6"	0.35 12.41	49.20 108.5	
W7652	Teak top 210x98cm	1		215x105x10cm 84.75x41.25x4"	0.23 7.97	25.00 55.1	
A7670CN-xxSET	Legs (set of 4pcs)	1		78x52x24cm 30.75x20.5x9.5"	0.10 3.44	7.60 16.8	
A7652CR-xx	Cross (for teak top)	1		142x31x7cm 56x12.25x2.75"	0.03 1.09	2.20 4.9	
07654-xx-xx	Dining table 300x110cm		2				
A7654-xx	Alu top 300x110cm	1		313x124x19cm 123.25x48.75x7.5"	0.74 26.04	111.60 246.1	
W7654	Teak top 300x110cm	1		305x115x10cm 120x45.25x4"	0.35 12.39	74.00 163.2	
A7670CN-xxSET	Legs (set of 4pcs)	1		78x52x24cm 30.75x20.5x9.5"	0.10 3.44	7.60 16.8	
A7654CR-xx	Cross (for teak top)	1		222x33x7cm 87.5x13x2.75"	0.05 1.81	7.00 15.4	
<b>CTR</b>							
01118-xx-xx	Armchair		2				
R1118B-xx	Back	2		82x65x29cm 32.25x25.5x11.5"	0.15 5.46	4.30 9.5	
R1118S-xx	Seat frame	2		59x58x50cm 23.25x22.75x19.75"	0.17 6.04	7.30 16.1	
01116-xx-xx	Bar chair		2				
R1118B-xx	Back	2		82x65x29cm 32.25x25.5x11.5"	0.15 5.46	4.30 9.5	
R1116S-xx	Seat frame	1		54x57x85cm 21.25x22.5x33.5"	0.26 9.24	11.50 25.4	

ARTICLE NR.	ARTICLE	BOX. CONTENT	NR. OF BOXES	BOX DIM. (LXD <sub>X</sub> H)	VOLUME	GROSS WEIGHT BOX
				CM IN	M <sup>3</sup> FT <sup>3</sup>	KG LB
01102-xx-xx	Lounge chair		2			
R1102B-xx	Back	2		92x92x38cm 36.25x36.25x15"	0.32 11.36	8.75 19.3
R1102S-xx	Seat frame	1		76x67x46cm 30x26.5x18"	0.23 8.27	19.25 42.4
01108-xx-xx	Sofa 2-Seater		2			
R1108B-xx	Back	2		173x83x38cm 68x32.75x15"	0.55 19.27	12.50 27.6
R1108S-xx	Seat frame	1		152x67x47cm 59.75x26.5x18.5"	0.48 16.90	36.35 80.2
01104-xx-xx	Right meridienne		2			
R1104B-xx	Back	1		108x108x48cm 42.5x42.5x19"	0.56 19.77	10.88 24.0
R1104S-xx	Seat frame	1		183x97x64cm 72x38.25x25.25"	1.14 40.12	86.45 190.6
01103-xx-xx	Left meridienne		2			
R1103B-xx	Back	1		108x108x48cm 42.5x42.5x19"	0.56 19.77	11.23 24.8
R1103S-xx	Seat frame	1		183x97x64cm 72x38.25x25.25"	1.14 40.12	85.95 189.5
<b>ELIO</b>						
02518-xx	Armchair	1	1	62x58x87cm 24.5x22.75x34.25"	0.3 10.6	13 28.7
02512-xx	Lounge Chair	1	1	79x69x85cm 31x27.25x33.5"	0.5 17.7	18 39.7
02520-xx	Lounge Chair High Back	1	1	91x75x104cm 35.75x29.5x41"	0.7 24.7	23 50.7
02508-xx	Sofa 2-seater	1	1	158x90x85cm 62.25x35.5x33.5"	1.2 42.4	43.6 96.1
02590-xx	Footstool	1	1	67x49x44cm 26.5x19.25x17.25"	0.1 3.5	7.4 16.3
<b>FORUM</b>						
06040-xx-xx	Adjustable lounger	1	1	200x70x35cm 78.75x27.5x13.75"	0.5 17.7	20.6 45.4
<b>ILLUM</b>						
06518-xx	Armchair	2	1	60x60x87cm 23.5x23.5x34.25"	0.3 10.6	9.1 20.1
06534-xx	Bench		2			
A6534-xx	Frame	1		218x47x17cm 85.75x18.5x6.75"	0.17 6.15	20.50 45.2
W6534	Seat teak	1		216x45x4cm 85x17.75x1.5"	0.04 1.37	27.00 59.5
06540-xx	Adjustable lounger	1	1	202x73x42cm 79.5x28.75x16.5"	0.6 21.2	31 68.4
06573-xx	Dining table 100x100cm		2			
A6573-xx	Frame Alu	1		106x106x16cm 41.75x41.75x6.25"	0.18 6.35	19.80 43.7
W6573	Frame Teak	1		103x103x13cm 40.5x40.5x5"	0.14 4.87	18.00 39.7
S2007G-xx S2007-Cxx	Table top ceramic	1		106x106x5cm 41.75x41.75x2"	0.06 1.98	27.00 59.5
W5002	Table top Teak	1		102x102x6cm 40.25x40.25x2.25"	0.06 2.20	15.90 35.1



ARTICLE NR.	ARTICLE	BOX. CONTENT	NR. OF BOXES	BOX DIM. (LXD <sub>X</sub> H)	VOLUME	GROSS WEIGHT BOX
				CM IN	M <sup>3</sup> FT <sup>3</sup>	KG LB
06550-xx	Dining table 152x100cm		2			
A6550-xx	Frame Alu	1		157x105x16cm 61.75x41.25x6.25"	0.26 9.31	24.65 54.4
W6550	Frame Teak	1		195x105x13cm 76.75x41.25x5"	0.27 9.40	23.00 50.7
S2008G-xx S2008-Cxx	Table top ceramic	1		160x109x8cm 63x43x3.25"	0.14 4.93	41.00 90.4
W5007	Table top Teak	1		154x101x4cm 60.75x39.75x1.5"	0.06 2.20	21.55 47.5
06552-xx-x	Dining table 212x100cm		2			
A6552-xx	Frame Alu	1		217x105x17cm 85.5x41.25x6.75"	0.39 13.68	28.60 63.1
W6552	Frame Teak	1		216x105x13cm 85x41.25x5"	0.29 10.41	33.00 72.8
S2005G-xx S2005-Cxx	Table top ceramic	1		219x107x8cm 86.25x42.25x3.25"	0.19 6.62	57.00 125.7
W5004	Table top teak	1		216x103x5cm 85x40.5x2"	0.11 3.93	34.00 75.0
06554-xx-x	Dining table 267x100cm		2			
A6554-xx	Frame Alu	1		272x105x17cm 107x41.25x6.75"	0.49 17.15	32.50 71.7
W6554	Frame Teak	1		272x105x13cm 107x41.25x5"	0.37 13.11	39.00 86.0
S2006G-xx S2006-Cxx	Table top ceramic	1		275x108x8cm 108.25x42.5x3.25"	0.24 8.39	72.00 158.8
W5005	Table top teak	1		270x101x5cm 106.25x39.75x2"	0.14 4.82	34.00 75.0
06552xs-xx-x	Slim dining table 212x71cm		2			
A6552xs-xx	Frame Alu	1		219x77x16cm 86.25x30.25x6.25"	0.27 9.53	25.45 56.1
W6552XS	Frame Teak	1		216x76x13cm 85x30x5"	0.21 7.54	24.00 52.9
S2020G-xx S2020-Cxx	Table top ceramic	1		219x80x8cm 86.25x31.5x3.25"	0.14 4.95	41.00 90.4
W5004S	Table top teak	1		216x75x5cm 85x29.5x2"	0.08 2.86	18.00 39.7
06554xs-xx-x	Slim dining table 265x71cm		2			
A6554xs-xx	Frame Alu	1		272x77x17cm 107x30.25x6.75"	0.36 12.57	29.95 66.0
S2021G-xx S2021-Cxx	Table top ceramic	1		275x80x8cm 108.25x31.5x3.25"	0.18 6.22	51.00 112.5
W5006S	Table top Teak	1		265x75x5cm 104.25x29.5x2"	0.10 3.51	25.00 55.1
06560-xx	Counter Height Table 152 x 100cm		3			
A6550-xx	Frame Alu	1		157x105x16cm 61.75x41.25x6.25"	0.26 9.31	24.65 54.4
A6579-xx	Table legs	1		86x12x12cm 33.75x4.75x4.75"	0.01 0.44	5.80 12.8
S2008G S2008-Cxx	Top Ceramic	1		160x109x8cm 63x43x3.25"	0.14 4.93	41.00 90.4
W5007	Top Teak			154x101x4cm 60.75x39.75x1.5"	0.06 2.20	21.55 47.5

ARTICLE NR.	ARTICLE	BOX. CONTENT	NR. OF BOXES	BOX DIM. (LXD <sub>X</sub> H)	VOLUME	GROSS WEIGHT BOX
				CM IN	M <sup>3</sup> FT <sup>3</sup>	KG LB
06564XS-xx	Counter Height Table 212x71cm		3			
A6552XS-xx	Frame	1		219x77x16cm 86.25x30.25x6.25"	0.27 9.53	25.45 56.1
A6579-xx	Table legs	1		86x12x12cm 33.75x4.75x4.75"	0.01 0.44	5.80 12.8
S2020G-xx S2020-Cxx	Table top ceramic	1		219x80x8cm 86.25x31.5x3.25"	0.14 4.95	41.00 90.4
W5004S	Table top Teak	1		216x75x5cm 85x29.5x2"	0.08 2.86	18.00 39.7
<b>KOS</b>						
04018	Armchair	4	1	71x75x109cm 28x29.5x43"	0.6 21.2	9.0 19.8
04012	Lounge chair	2	1	74x62x83cm 29.25x24.5x32.75"	0.4 14.1	10.5 23.2
04090	Footrest/Side table	1	1	53x48x25cm 20.75x19x9.75"	0.06 2.1	6.8 15.0
04016	Bar chair	1	1	52x42x105cm 20.5x16.5x41.25"	0.2 7.1	9.4 20.7
04040	Adjustable lounger	1	1	203x75x28cm 80x29.5x11"	0.4 14.1	33.9 74.7
04034	Bench	1	1	201x45x15cm 79.25x17.75x6"	0.1 3.5	25 55.1
04073	Dining table 98x98cm	1	1	108x108x15cm 42.5x42.5x6"	0.2 7.1	36 79.4
04052	Dining table 224x100cm	1	1	228x103x18cm 89.75x40.5x7"	0.4 14.1	61.1 134.7
04053	Dining table 266x100cm	1	1	271x103x17cm 106.75x40.5x6.75"	0.5 17.7	73.7 162.5
04054	Dining table 308x110cm	1	1	318x118x21cm 125.25x46.5x8.25"	0.8 28.3	124 273.4
<b>MOOD</b>						
06218-xx	Armchair	1	1	61x61x52cm 24x24x20.5"	0.2 7.1	11.6 25.6
06216-xx	Bar chair	1	1	62x62x84cm 24.5x24.5x33"	0.3 10.6	14.4 31.8
06202-xx	Lounge chair		2			
A6202-xx	Alu back frame	2		90x56x71cm 35.5x22x28"	0.36 12.64	12.00 26.5
W6202	Teak frame	1		70x70x10cm 27.5x27.5x4"	0.05 1.73	10.95 24.1
06208-xx	Sofa 2-seater		2			
A6208-xx	Alu back frame	2		167x72x60cm 65.75x28.25x23.5"	0.72 25.48	9.48 20.9
W6208	Teak frame	1		150x70x10cm 59x27.5x4"	0.11 3.71	18.60 41.0
06209-xx	Sofa 3-seater		2			
A6209-xx	Alu back frame	2		236x75x56cm 93x29.5x22"	0.99 35.00	12.40 27.3
W6209	Teak frame	1		214x78x10cm 84.25x30.75x4"	0.17 5.89	13.00 28.7
06249-xx	Daybed		2			
A6249-xx	Alu back frame	2		176x164x48cm 69.25x64.5x19"	1.39 48.93	14.63 32.2
W6249	Teak frame	1		168x142x9cm 66.25x56x3.5"	0.21 7.58	35.60 78.5



ARTICLE NR.	ARTICLE	BOX. CONTENT	NR. OF BOXES	BOX DIM. (LXDHXH)	VOLUME	GROSS WEIGHT BOX
				CM IN	M <sup>3</sup> FT <sup>3</sup>	KG LB
06250-xx	Lounge bed		2			
A6250-xx	Alu back frame	2		155x173x50cm 61x68x19.75"	1.34 47.35	14.75 32.5
W6250	Teak frame	1		128x140x10cm 50.5x55x4"	0.18 6.33	28.75 63.4
06282	Coffee table 66x66cm	1	1	70x70x13cm 27.5x27.5x5"	0.06 2.1	12.9 28.4
06284	Coffee table 120x60cm	1	1	128x70x13cm 50.5x27.5x5"	0.1 3.5	20.7 45.6
<b>NATAL ALU</b>						
05918-89-89	Armchair	2	1	63x54x92cm 24.75x21.25x36.25"	0.3 10.6	8.5 18.7
05912-89-89	Lounge chair	2	1	78x62x82cm 30.75x24.5x32.25"	0.4 14.1	10.2 22.5
05940-89-89	Adjustable lounger	1	1	208x75x37cm 82x29.5x14.5"	0.6 21.2	28.6 63.1
<b>NATAL ALU SOFA</b>						
<b>STAND ALONE</b>						
05802-x	Armchair 90cm	1	1	103x79x11cm 40.5x31x4.25"	0.09 3.2	15.4 34.0
05808S-x	2-Seater Regular 189cm	1	1	198x86x11cm 78x33.75x4.25"	0.2 7.1	26.1 57.6
05809S-x	3-Seater Regular 189cm	1	1	283x86x11cm 111.5x33.75x4.25"	0.3 10.6	34.3 75.6
05808D-x	2-Seater Deep 189cm	1	1	198x110x11cm 78x43.25x4.25"	0.2 7.1	29.2 64.4
05809D-x	3- Seater Deep 189cm	1	1	282x110x11cm 111x43.25x4.25"	0.3 10.6	38.4 84.7
05868-x - 05869-x	Meridienne Left/Right	1	1	194x103,500x11cm 76.5x40,748x4.25"	0.2 7.1	26.4 58.2
<b>MODULAR</b>						
05828S	Centre Module 2-Seater Regular	1	1	198x86x11cm 78x33.75x4.25"	0.2 7.1	26.1 57.6
05838RS / 05838LS	Right/Left Arm Extension 2-seater Regular	1	1	198x86x11cm 78x33.75x4.25"	0.2 7.1	26.1 57.6
05848RS / 05848LS	Right/Left Arm Corner Module 2-Seater Regular	1	1	198x86x11cm 78x33.75x4.25"	0.2 7.1	26.1 57.6
05858RS / 05858LS	Right/Left Corner Extension 2-seater Regular	1	1	198x86x11cm 78x33.75x4.25"	0.2 7.1	26.1 57.6
05829S	Centre Module 3-seater Regular	1	1	283x86x11cm 111.5x33.75x4.25"	0.3 10.6	34.3 75.6
05839RS / 05839LS	Right/Left Arm Extension 3-seater Regular	1	1	283x86x11cm 111.5x33.75x4.25"	0.3 10.6	34.3 75.6
05849RS / 05849LS	Right/Left Arm Corner Module 3-seater Regular	1	1	283x86x11cm 111.5x33.75x4.25"	0.3 10.6	37 81.6
05859RS / 05859LS	Right/Left Corner Extension 3-seater Regular	1	1	283x86x11cm 111.5x33.75x4.25"	0.3 10.6	34.3 75.6
05828D	Centre Module 2-seater Deep	1	1	198x110x11cm 78x43.25x4.25"	0.2 7.1	29.2 64.4
05838RD / 05838LD	Right/Left Arm Extension 2-seater Deep	1	1	198x110x11cm 78x43.25x4.25"	0.2 7.1	29.2 64.4
05848RD / 05848LD	Right/Left Arm Corner Module 2-seater Deep	1	1	198x110x11cm 78x43.25x4.25"	0.2 7.1	29.2 64.4
05858RD / 05858LD	Right/Left Corner Extension 2-seater Deep	1	1	198x110x11cm 78x43.25x4.25"	0.2 7.1	29.2 64.4

ARTICLE NR.	ARTICLE	BOX. CONTENT	NR. OF BOXES	BOX DIM. (LXDXH)	VOLUME	GROSS WEIGHT BOX
				CM IN	M <sup>3</sup> FT <sup>3</sup>	KG LB
05829D	Centre Module 3-seater Deep	1	1	280x210x11cm 110.25x82.75x4.25"	0.6 21.2	38.3 84.5
05839RD / 05839LD	Right/Left Arm Extension 3-seater Deep	1	1	280x210x11cm 110.25x82.75x4.25"	0.6 21.2	38.3 84.5
05849RD / 05849LD	Right/Left Arm Corner Module 3-seater Deep	1	1	280x210x11cm 110.25x82.75x4.25"	0.6 21.2	38.3 84.5
05859RD / 05859LD	Right/Left Corner Extension 3-seater Deep	1	1	280x210x11cm 110.25x82.75x4.25"	0.6 21.2	38.3 84.5
05803-x / 05804-x	Meridienne Left/Right	1	1	134x104x11cm 52.75x41x4.25"	0.2 7.1	26.4 58.2
<b>NATAL ALU X TABLES</b>						
06176-x	Coffee table high dia 35cm	1	1	45x45x54cm 17.75x17.75x21.25"	0.1 3.5	6.4 14.1
06180-x	Coffee table low 40x40cm	1	1	42x42x37cm 16.5x16.5x14.5"	0.07 2.5	7.6 16.8
06182-x	Coffee table low 60x60cm	1	1	63x63x38cm 24.75x24.75x15"	0.2 7.1	15.5 34.2
<b>NODI</b>						
01918-xx	Armchair	1	1	66x68x94cm 26x26.75x37"	0.4 14.1	17.3 38.1
01912-xx	Lounge chair	1	1	78x70x79cm 30.75x27.5x31"	0.4 14.1	17.6 38.8
01940-xx	Lounger	1	1	203x85x61cm 80x33.5x24"	1.1 38.8	48.6 107.2
<b>NODI SOFA</b>						
01950-xx	Nodi Sofa Regular Single module		2			
A1902-xx	Seat plate + base Regular	1	1	79x79x10cm 31x31x4"	0.06 2.20	14.70 32.4
R1902-xx	Backrest extension	1	1	88x63x34cm 34.75x24.75x13.5"	0.19 6.66	8.65 19.1
01951-xx / 01952-xx	Nodi Sofa Regular Right/Left Arm + Back		2			
A1902-xx	Seat plate + base Regular	1	1	79x79x10cm 31x31x4"	0.06 2.20	14.70 32.4
R1901-xx	Backrest Corner	1	1	100x100x64cm 39.25x39.25x25.25"	0.64 22.60	13.40 29.5
01953-xx / 01954-xx	Nodi Sofa Regular Right/Left Arm + Corner		2			
A1902-xx	Seat plate + base Regular	1	1	79x79x10cm 31x31x4"	0.06 2.20	14.70 32.4
R1901-xx	Backrest Corner	1	1	100x100x64cm 39.25x39.25x25.25"	0.64 22.60	13.40 29.5
01955-xx	Nodi Sofa Regular Pouf		1			
A1902-xx	Seat plate + base Regular	1	1	79x79x10cm 31x31x4"	0.06 2.20	14.70 32.4
01960-xx	Nodi Sofa Deep Single module		2			
A1903-xx	Seat plate + base Deep	1	1	95x78x10cm 37.5x30.75x4"	0.07 2.62	18.10 39.9
R1902-xx	Backrest extension	1	1	88x63x34cm 34.75x24.75x13.5"	0.19 6.66	8.65 19.1
01961-xx / 01962-xx	Nodi Sofa Deep Right/Left Arm + Back		2			
A1903-xx	Seat plate + base Deep	1	1	95x78x10cm 37.5x30.75x4"	0.07 2.62	18.10 39.9
R1901-xx	Backrest Corner	1	1	100x100x64cm 39.25x39.25x25.25"	0.64 22.60	13.40 29.5



ARTICLE NR.	ARTICLE	BOX. CONTENT	NR. OF BOXES	BOX DIM. (LXDXH)	VOLUME	GROSS WEIGHT BOX
				CM IN	M <sup>3</sup> FT <sup>3</sup>	KG LB
01963-xx / 01964-xx	Nodi Sofa Deep Right/Left Arm + Corner		2			
A1903-xx	Seat plate + base Deep	1	1	95x78x10cm 37.5x30.75x4"	0.07 2.62	18.10 39.9
R1901-xx	Backrest Corner	1	1	100x100x64cm 39.25x39.25x25.25"	0.64 22.60	13.40 29.5
01965-xx	Nodi Sofa Deep Pouf		1			
A1903-xx	Seat plate + base Deep	1	1	95x78x10cm 37.5x30.75x4"	0.07 2.62	18.10 39.9
01970-xx	Nodi Sofa Lounge Single module		2			
A1904-xx	Seat plate + base Large	1	1	133x78x10cm 52.25x30.75x4"	0.10 3.66	23.40 51.6
R1902-xx	Backrest extension	1	1	88x63x34cm 34.75x24.75x13.5"	0.19 6.66	8.65 19.1
01971-xx / 01972-xx	Nodi Sofa Lounge Right/Left Arm + Back		2			
A1904-xx	Seat plate + base Large	1	1	133x78x10cm 52.25x30.75x4"	0.10 3.66	23.40 51.6
R1901-xx	Backrest Corner	1	1	100x100x64cm 39.25x39.25x25.25"	0.64 22.60	13.40 29.5
01973-xx / 01974-xx	Nodi Sofa Lounge Right/Left Arm + Corner		2			
A1904-xx	Seat plate + base Large	1	1	133x78x10cm 52.25x30.75x4"	0.10 3.66	23.40 51.6
R1901-xx	Backrest Corner	1	1	100x100x64cm 39.25x39.25x25.25"	0.64 22.60	13.40 29.5
01975-xx	Nodi Sofa Lounge Pouf		1			
A1904-xx	Seat plate + base Large	1	1	133x78x10cm 52.25x30.75x4"	0.10 3.66	23.40 51.6
01980-xx	Nodi Sofa Meridienne Single module		3			
A1902-xx	Seat plate + base Regular	1	2	79x79x10cm 31x31x4"	0.06 2.20	14.70 32.4
R1902-xx	Backrest extension	1	1	88x63x34cm 34.75x24.75x13.5"	0.19 6.66	8.65 19.1
01981-xx / 01982-xx	Nodi Sofa Meridienne Right/Left Arm + Back		3			
A1902-xx	Seat plate + base Regular	1	2	79x79x10cm 31x31x4"	0.06 2.20	14.70 32.4
R1901-xx	Backrest Corner	1	1	100x100x64cm 39.25x39.25x25.25"	0.64 22.60	13.40 29.5
01983-xx / 01984-xx	Nodi Sofa Meridienne Right/Left Arm + Corner		3			
A1902-xx	Seat plate + base Regular	1	2	79x79x10cm 31x31x4"	0.06 2.20	14.70 32.4
R1901-xx	Backrest Corner	1	1	100x100x64cm 39.25x39.25x25.25"	0.64 22.60	13.40 29.5
01985-xx	Nodi Sofa Meridienne Pouf		2			
A1902-xx	Seat plate + base Regular	1	2	79x79x10cm 31x31x4"	0.06 2.20	14.70 32.4
<b>NOMAD</b>						
05018	Armchair	1	1	68x62x85cm 26.75x24.5x33.5"	0.4 14.1	11 24.3
05012	Lounge Chair	1	1	76x75x73cm 30x29.5x28.75"	0.4 14.1	16.5 36.4

ARTICLE NR.	ARTICLE	BOX. CONTENT	NR. OF BOXES	BOX DIM. (LXDXH)	VOLUME	GROSS WEIGHT BOX
				CM IN	M <sup>3</sup> FT <sup>3</sup>	KG LB
<b>NOX</b>						
02252-xx	Nox dining table 264 cm					
R2252-x	Frame	1		266x110x27cm 104.75x43.25x10.75"	0.79 27.90	158.65 349.8
S2254-Lx S2652-Cx	Glazed lavastone Top Ceramic Top	9		109x58x51cm 43x22.75x20"	0.32 11.39	21.00 46.3
02254-xx	Nox dining table 352 cm					
R2254-x	Frame	1		363x120x27cm 143x47.25x10.75"	1.18 41.53	185.00 407.9
S2254-Lx S2652-Cx	Glazed lavastone Top Ceramic Top	12		109x58x51cm 43x22.75x20"	0.32 11.39	21.00 46.3
<b>OTTO TABLES</b>						
04266-xx	Otto Dining Table - Dia 148cm		2			
W4250	Frame	1		36x36x47cm 14.25x14.25x18.5"	0.06 2.15	10.00 22.1
S4266-Cx	Ceramic Top	1		58x58x6cm 22.75x22.75x2.25"	0.02 0.71	5.69 12.5
S4266-TV	Travertin Top	1		58x58x6cm 22.75x22.75x2.25"	0.02 0.71	5.69 12.5
04254-Cx	Otto Dining Table - 320x110cm		2			
W4251	Frame	1		36x36x47cm 14.25x14.25x18.5"	0.06 2.15	10.00 22.1
S4254-Cx	Ceramic Top	1		58x58x6cm 22.75x22.75x2.25"	0.02 0.71	5.69 12.5
04253-TV	Otto Dining Table - 290x110cm		2			
W4251	Frame	1		36x36x47cm 14.25x14.25x18.5"	0.06 2.15	10.00 22.1
S4253-TV	Travertin Top	1		58x58x6cm 22.75x22.75x2.25"	0.02 0.71	5.69 12.5
04281-xx	Otto Side Table - Dia 48cm - H32cm		2			
W4281	Small - Low Frame	1		34x34x35cm 13.5x13.5x13.75"	0.04 1.43	5.50 12.1
S4280-Cx	Ceramic Top	1		58x58x6cm 22.75x22.75x2.25"	0.02 0.71	5.69 12.5
S4280-TV	Travertin Top	1		70x70x6cm 27.5x27.5x2.25"	0.03 1.04	8.89 19.6
W4286	Teak Top - Dia 48cm	1		52x52x6cm 20.5x20.5x2.25"	0.02 0.57	4.00 8.8
04283-xx	Otto Side Table - Dia 60cm - H32cm					
W4281	Small - Low Frame	1		34x34x35cm 13.5x13.5x13.75"	0.04 1.43	5.50 12.1
S4282-Cx	Ceramic Top	1		70x70x6cm 27.5x27.5x2.25"	0.03 1.04	8.89 19.6
S4282-TV	Travertin Top	1		100x100x6cm 39.25x39.25x2.25"	0.06 2.12	20.00 44.1
W4288	Teak Top - Dia 60cm	1		64x64x6cm 25.25x25.25x2.25"	0.02 0.87	4.00 8.8



ARTICLE NR.	ARTICLE	BOX. CONTENT	NR. OF BOXES	BOX DIM. (LXDXH)	VOLUME	GROSS WEIGHT BOX
				CM IN	M <sup>3</sup> FT <sup>3</sup>	KG LB
04284-xx	Otto Side Table - Dia 90cm - H32cm		2			
W4284	Large - Low Frame	1		67x67x34cm 26.5x26.5x13.5"	0.15 5.39	12.00 26.5
S4284-Cx	Ceramic Top	1		100x100x6cm 39.25x39.25x2.25"	0.06 2.12	20.00 44.1
S4284-TV	Travertin Top	1		100x100x6cm 39.25x39.25x2.25"	0.06 2.12	26.06 57.5
W4290	Teak Top - Dia 90cm	1		94x94x6cm 37x37x2.25"	0.05 1.87	15.00 33.1
04280-xx	Otto Side Table - Dia 48cm - H45cm		2			
W4280	Small - High Frame	1		36x36x47cm 14.25x14.25x18.5"	0.06 2.15	10.00 22.1
S4280-Cx	Ceramic Top	1		58x58x6cm 22.75x22.75x2.25"	0.02 0.71	5.69 12.5
S4280-TV	Travertin Top	1		70x70x6cm 27.5x27.5x2.25"	0.03 1.04	8.89 19.6
W4286	Teak Top - Dia 48cm	1		52x52x6cm 20.5x20.5x2.25"	0.02 0.57	4.00 8.8
04282-xx	Otto Side Table - Dia 60cm - H45cm		2			
W4280	Small - High Frame	1		36x36x47cm 14.25x14.25x18.5"	0.06 2.15	10.00 22.1
S4282-Cx	Ceramic Top	1		70x70x6cm 27.5x27.5x2.25"	0.03 1.04	8.89 19.6
S4282-TV	Travertin Top	1		100x100x6cm 39.25x39.25x2.25"	0.06 2.12	20.00 44.1
W4288	Teak Top - Dia 60cm	1		64x64x6cm 25.25x25.25x2.25"	0.02 0.87	4.00 8.8
<b>PAVILION DAYBED</b>						
01811-x-y-z	Aluminium - Aluminium		3			
A1800-x	Base	1		227x217x23cm 89.25x85.5x9"	1.13 40.01	95.00 209.5
A1801-y	Rear wall aluminium	1		218x192x12cm 85.75x75.5x4.75"	0.50 17.74	51.00 112.5
A1805-z	Roof aluminium	1		229x217x15cm 90.25x85.5x6"	0.75 26.32	93.00 205.1
01813-x-y-z	Aluminium - Movable Sunvision		3			
A1800-x	Base	1		227x217x23cm 89.25x85.5x9"	1.13 40.01	95.00 209.5
A1801-y	Rear wall aluminium	1		218x192x12cm 85.75x75.5x4.75"	0.50 17.74	51.00 112.5
A1807-z	Roof movable Sunvision	1		224x14x114cm 88.25x5.5x45"	0.36 12.63	49.00 108.0
01814-x-y-z	Aluminium - Teak		3			
A1800-x	Base	1		227x217x23cm 89.25x85.5x9"	1.13 40.01	95.00 209.5
A1801-y	Rear wall aluminium	1		218x192x12cm 85.75x75.5x4.75"	0.50 17.74	51.00 112.5
W1808	Roof teak	1		220x228x18cm 86.5x89.75x7"	0.90 31.89	72.00 158.8
01821-x-y-z	Sunvision - Aluminium		3			
A1800-x	Base	1		227x217x23cm 89.25x85.5x9"	1.13 40.01	95.00 209.5
A1802-y	Rear wall Sunvision	1		193x23x11cm 76x9x4.25"	0.05 1.72	15.60 34.4
A1805-z	Roof aluminium	1		229x217x15cm 90.25x85.5x6"	0.75 26.32	93.00 205.1

ARTICLE NR.	ARTICLE	BOX. CONTENT	NR. OF BOXES	BOX DIM. (LXD <sub>X</sub> H)	VOLUME	GROSS WEIGHT BOX
				CM IN	M <sup>3</sup> FT <sup>3</sup>	KG LB
01823-x-y-z	Sunvision - Movable Sunvision		3			
A1800-x	Base	1		227x217x23cm 89.25x85.5x9"	113 40.01	95.00 209.5
A1802-y	Rear wall Sunvision	1		193x23x11cm 76x9x4.25"	0.05 1.72	15.60 34.4
A1807-z	Movable Sunvision	1		224x14x114cm 88.25x5.5x45"	0.36 12.63	49.00 108.0
01824-x-y-z	Sunvision - Teak		3			
A1800-x	Base	1		227x217x23cm 89.25x85.5x9"	113 40.01	95.00 209.5
A1802-y	Rear wall Sunvision	1		193x23x11cm 76x9x4.25"	0.05 1.72	15.60 34.4
W1808	Roof teak	1		220x228x18cm 86.5x89.75x7"	0.90 31.89	72.00 158.8
01831-x-y-z	Teak - Aluminium		3			
A1800-x	Base	1		227x217x23cm 89.25x85.5x9"	113 40.01	95.00 209.5
W1803	Rear wall teak	1		220x194x13cm 86.5x76.5x5"	0.55 19.59	55.00 121.3
A1805-z	Roof aluminium	1		229x217x15cm 90.25x85.5x6"	0.75 26.32	93.00 205.1
01833-x-y-z	Teak - Movable Sunvision		3			
A1800-x	Base	1		227x217x23cm 89.25x85.5x9"	113 40.01	95.00 209.5
W1803	Rear wall teak	1		220x194x13cm 86.5x76.5x5"	0.55 19.59	55.00 121.3
A1807-z	Roof Movable Sunvision	1		224x14x114cm 88.25x5.5x45"	0.36 12.63	49.00 108.0
01834-x-y-z	Teak - Teak		3			
A1800-x	Base	1		227x217x23cm 89.25x85.5x9"	113 40.01	95.00 209.5
W1803	Rear wall teak	1		220x194x13cm 86.5x76.5x5"	0.55 19.59	55.00 121.3
W1808	Roof teak	1		220x228x18cm 86.5x89.75x7"	0.90 31.89	72.00 158.8
01841-x-y-z	Empty - Aluminium		3			
A1800-x	Base	1		227x217x23cm 89.25x85.5x9"	113 40.01	95.00 209.5
A1804	Rear wall Empty	1		193x14x8cm 76x5.5x3.25"	0.02 0.76	11.50 25.4
A1805-z	Roof aluminium	1		229x217x15cm 90.25x85.5x6"	0.75 26.32	93.00 205.1
01843-x-y-z	Empty - Movable Sunvision		3			
A1800-x	Base	1		227x217x23cm 89.25x85.5x9"	113 40.01	95.00 209.5
A1804	Rear wall Empty	1		193x14x8cm 76x5.5x3.25"	0.02 0.76	11.50 25.4
A1807-z	Roof movable Sunvision	1		224x14x114cm 88.25x5.5x45"	0.36 12.63	49.00 108.0
01844-x-y-z	Empty - Teak		3			
A1800-x	Base	1		227x217x23cm 89.25x85.5x9"	113 40.01	95.00 209.5
A1804-x	Rear wall Empty	1		193x14x8cm 76x5.5x3.25"	0.02 0.76	11.50 25.4
W1808	Roof teak	1		220x228x18cm 86.5x89.75x7"	0.90 31.89	72.00 158.8



ARTICLE NR.	ARTICLE	BOX. CONTENT	NR. OF BOXES	BOX DIM. (LXDXH)  CM IN	VOLUME  M <sup>3</sup> FT <sup>3</sup>	GROSS WEIGHT BOX  KG LB
<b>PURE SOFA</b>						
01202s	Armchair	1	1	98x93x13cm 38.5x36.5x5"	0.1 3.5	20.7 45.6
01201	Corner Sofa	1	1	96x96x17cm 37.75x37.75x6.75"	0.2 7.1	22.7 50.1
01203	Left arm sofa	1	1	190x94x14cm 74.75x37x5.5"	0.3 10.6	35.9 79.2
01204	Right arm sofa	1	1	191x97x14cm 75.25x38.25x5.5"	0.3 10.6	36.5 80.5
01207	2-Seater Sofa	1	1	204x98x15cm 80.25x38.5x6"	0.3 10.6	34.8 76.7
01285	C-Table teak	1	1	44x37x49cm 17.25x14.5x19.25"	0.08 2.8	12.7 28.0
01249	Pure Cabana Daybed		2			
W1249	Cabana Daybed Frame	1		230x200x30cm 90.5x78.75x11.75"	1.38 48.73	50.00 110.3
P1249-xx	Cabana Sunscape	1		48x43x9cm 19x17x3.5"	0.02 0.66	5.00 11.0
01242	Pure Lounger		1			
W1242	Pure Lounger - Frame	1		218x95x11cm 85.75x37.5x4.25"	0.23 8.05	17.00 37.5
01243	Pure Lounger with Wheels		2			
W1242	Pure Lounger - Frame	1		218x95x11cm 85.75x37.5x4.25"	0.23 8.05	17.00 37.5
W1242WH	Wheels set	1		92x17x29cm 36.25x6.75x11.5"	0.05 1.60	7.00 15.4
01244	Pure Lounger with Legs		2			
W1242	Pure Lounger - Frame	1		218x95x11cm 85.75x37.5x4.25"	0.23 8.05	17.00 37.5
W1242L	Legs set	1		92x14x18cm 36.25x5.5x7"	0.02 0.82	7.00 15.4
<b>SENJA</b>						
02318-xx	Senja Armchair	1	1	63x64x84cm 24.75x25.25x33"	0.3 10.6	12.6 27.8
02312-xx	Senja Lounge Chair	1	1	80x72x78cm 31.5x28.25x30.75"	0.4 14.1	15.9 35.1
02340-xx	Senja Lounger		1			
A2340-xx	Senja Lounger frame	1		210x81x30cm 82.75x32x11.75"	0.51 18.02	28.00 61.7
02341-xx	Senja Lounger with Teak table top		3			
A2340-xx	Senja Lounger frame	1	1	210x81x30cm 82.75x32x11.75"	0.51 18.02	28.00 61.7
W2340	Teak Table	1	1	208x29x6cm 82x11.5x2.25"	0.04 1.28	7.30 16.1
A2341-xx	supports side table	1	1	26x11x12cm 10.25x4.25x4.75"	0.00 0.12	1.00 2.2
<b>SENJA SOFA</b>						
<b>FRAMES</b>						
A2302S-x	1 seater Regular	1	1	84x73x8cm 33x28.75x3.25"	0.05 1.73	10.65 23.5
A2308S-x	2 seater Regular	1	1	167x73x8cm 65.75x28.75x3.25"	0.10 3.44	16.35 36.1

ARTICLE NR.	ARTICLE	BOX. CONTENT	NR. OF BOXES	BOX DIM. (LXDXH)	VOLUME	GROSS WEIGHT BOX
				CM IN	M <sup>3</sup> FT <sup>3</sup>	KG LB
A2308D-x	2 seater Deep	1	1	187x98x8cm 73.5x38.5x3.25"	0.15 5.18	19.10 42.1
A2309S-x	3 seater Regular	1	1	251x74x8cm 98.75x29.25x3.25"	0.15 5.25	22.60 49.8
A2309D-x	3 seater Deep	1	1	251x98x8cm 98.75x38.5x3.25"	0.20 6.95	26.15 57.7
<b>LEGS</b>						
A2311-x	Alu legs set of 4	1	1	24x8x8cm 9.5x3.25x3.25"	0.00 0.05	1.30 2.9
W2311	Teak legs set of 4	1	1	25x19x7cm 9.75x7.5x2.75"	0.00 0.12	0.75 1.7
<b>TABLES + SUPPORT</b>						
A2381-x	Side table frame	1	1	25x18x18cm 9.75x7x7"	0.01 0.29	1.30 2.9
W2381	Side table teak top	1	1	48x39x6cm 19x15.25x2.25"	0.01 0.40	2.40 5.3
S2381	Side table glazed lava stone top	1	1	46x37x4cm 18x14.5x1.5"	0.01 0.24	9.25 20.4
A2387-x	Console table frame	1	1	148x76x9cm 58.25x30x3.5"	0.10 3.57	7.75 17.1
W2387	Console table teak top	1	1	166x38x6cm 65.25x15x2.25"	0.04 1.34	8.95 19.7
S2387	Console table glazed lava stone top	1	1	166x37x5cm 65.25x14.5x2"	0.03 1.08	37.80 83.3
A2370-x	Table top support	1	1	68x9x7cm 26.75x3.5x2.75"	0.00 0.15	1.60 3.5
W2370S	Table top teak regular	1	1	89x77x6cm 35x30.25x2.25"	0.04 1.45	9.95 21.9
W2370D	Table top teak deep	1	1	102x89x6cm 40.25x35x2.25"	0.05 1.92	13.50 29.8
S2370S	Table top glazed lava stone regular	1	1	87x76x4cm 34.25x30x1.5"	0.03 0.93	38.85 85.7
S2370D	Table top glazed lava stone deep	1	1	100x87x4cm 39.25x34.25x1.5"	0.03 1.23	50.60 111.6
<b>ARMREST</b>						
R2303-x	Armrest regular high	1	1	59x42x9cm 23.25x16.5x3.5"	0.02 0.79	2.60 5.7
R2304-x	Armrest regular low	1	1	27x59x9cm 10.75x23.25x3.5"	0.01 0.51	2.35 5.2
R2305-x	Armrest deep high	1	1	83x42x9cm 32.75x16.5x3.5"	0.03 1.11	3.15 6.9
R2306-x	Armrest deep low	1	1	83x28x9cm 32.75x11x3.5"	0.02 0.74	2.75 6.1
<b>BACKREST</b>						
R2301-x	Backrest high	1	1	70x42x9cm 27.5x16.5x3.5"	0.03 0.93	2.90 6.4
R2302-x	Backrest low	1	1	70x27x9cm 27.5x10.75x3.5"	0.02 0.60	2.50 5.5
<b>SURO</b>						
02718-20-xx	Suro Armchair - Alu		2			
R2718B-xx	SS - Back	1		61x48x49cm 24x19x19.25"	0.14 5.07	10.00 22.1
A2718S-20	Alu - Seat - Clay	1		62x60x56cm 24.5x23.5x22"	0.21 7.36	11.00 24.3



ARTICLE NR.	ARTICLE	BOX. CONTENT	NR. OF BOXES	BOX DIM. (LXDXH)	VOLUME	GROSS WEIGHT BOX
				CM IN	M <sup>3</sup> FT <sup>3</sup>	KG LB
02718-T-xx	Suro Armchair - Teak		2			
R2718B-xx	SS - Back	1		61x48x49cm 24x19x19.25"	0.14 5.07	10.00 22.1
W2718	Teak - Seat	1		54x51x56cm 21.25x20x22"	0.15 5.45	5.60 12.3
02712-20-xx	Suro Lounge Chair - Alu		2			
R2712B-xx	SS - Back	1		73x61x55cm 28.75x24x21.75"	0.24 8.65	12.00 26.5
A2712S-20	Alu - Seat - Clay	1		71x70x44cm 28x27.5x17.25"	0.22 7.72	14.00 30.9
02712-T-xx	Suro Lounge Chair - Teak		2			
R2712B-xx	SS - Back	1		73x61x55cm 28.75x24x21.75"	0.24 8.65	12.00 26.5
W2712	Teak - Seat	1		61x61x44cm 24x24x17.25"	0.16 5.78	7.90 17.4
02708-20-xx	Suro Banquette - Alu		2			
R2708B-xx	SS - Back	1		163x71x52cm 64.25x28x20.5"	0.60 21.25	28.00 61.7
A2708S-20	Alu - Seat	1		163x86x46cm 64.25x33.75x18"	0.64 22.77	15.00 33.1
02708-T-xx	Suro Banquette - Teak		2			
R2708B-xx	SS - Back	1		163x71x52cm 64.25x28x20.5"	0.60 21.25	28.00 61.7
W2708	Teak - Seat	1		158x74x38cm 62.25x29.25x15"	0.44 15.69	11.90 26.2
02752-T	Suro Dining Table 210cm - Teak		3			
W2752	Frame - 210cm	1		213x113x90cm 83.75x44.5x35.5"	2.17 76.50	58.00 127.9
W2750	Legs - set of 2	2		243x250x85cm 95.75x98.5x33.5"	5.16 182.36	23.00 50.7
02753-T	Suro Dining Table 280cm - Teak		3			
W2753	Frame - 280cm	1		284x113x90cm 111.75x44.5x35.5"	2.89 102.00	70.00 154.4
W2750	Legs - set of 2	2		243x250x85cm 95.75x98.5x33.5"	5.16 182.36	23.00 50.7
02754-T	Suro Dining Table 420cm - Teak		7			
W2752	Frame - 210cm	2		213x113x90cm 83.75x44.5x35.5"	2.17 76.50	58.00 127.9
W2750	Legs - set of 2	2		243x250x85cm 95.75x98.5x33.5"	5.16 182.36	23.00 50.7
W2755	Support Leg	2		178x178x79cm 70x70x31"	2.50 88.39	10.00 22.1
02755-T	Suro Dining Table 490cm - Teak		8			
W2752	Frame - 210cm	1		213x113x90cm 83.75x44.5x35.5"	2.17 76.50	58.00 127.9
W2753	Frame - 280cm	1		284x113x90cm 111.75x44.5x35.5"	2.89 102.00	70.00 154.4
W2750	Legs - set of 2	2		243x250x85cm 95.75x98.5x33.5"	5.16 182.36	23.00 50.7
W2755	Support Leg	3		178x178x79cm 70x70x31"	2.50 88.39	10.00 22.1

ARTICLE NR.	ARTICLE	BOX. CONTENT	NR. OF BOXES	BOX DIM. (LXDXH)	VOLUME	GROSS WEIGHT BOX
				CM IN	M <sup>3</sup> FT <sup>3</sup>	KG LB
02756-T	Suro Dining Table 560cm - Teak		9			
W2753	Frame - 280cm	2		284x113x90cm 111.75x44.5x35.5"	2.89 102.00	70.00 154.4
W2750	Legs - set of 2	2		243x250x85cm 95.75x98.5x33.5"	5.16 182.36	23.00 50.7
W2755	Support Leg	4		178x178x79cm 70x70x31"	2.50 88.39	10.00 22.1
02757-T	Suro Dining Table 630cm - Teak		11			
W2752	Frame - 210cm	3		213x113x90cm 83.75x44.5x35.5"	2.17 76.50	58.00 127.9
W2750	Legs - set of 2	2		243x250x85cm 95.75x98.5x33.5"	5.16 182.36	23.00 50.7
W2755	Support Leg	4		178x178x79cm 70x70x31"	2.50 88.39	10.00 22.1
<b>T-TABLE</b>						
D2166 / D2167 / D2168	Dia 80 - H75cm / H67cm / H35cm		4			
R2161-xx	Bottom plate dia 47,5cm	1		53x53x7cm 20.75x20.75x2.75"	0.02 0.69	16.00 35.3
R2160H-xx	Tube high <b>H75cm</b>	1		73x10x10cm 28.75x4x4"	0.01 0.26	4.45 9.8
R2160M-xx	Tube medium <b>H67cm</b>	1		67x10x10cm 26.5x4x4"	0.01 0.24	4.00 8.8
R2160L-xx	Tube low <b>H35cm</b>	1		34x20x15cm 13.5x7.75x6"	0.01 0.36	2.05 4.5
R2163-xx	Top plate	1		44x44x6cm 17.25x17.25x2.25"	0.01 0.41	6.40 14.1
S2161-Cxx	Ceramic top dia 80cm	1		90x90x6cm 35.5x35.5x2.25"	0.05 1.72	16.00 35.3
S2161-Lxx	Lavastone top dia 80cm	1		101x101x5cm 39.75x39.75x2"	0.05 1.80	33.00 72.8
W2160	Teak top dia 80cm	1		85x85x7cm 33.5x33.5x2.75"	0.05 1.79	12.00 26.5
D2160 / D2161 / D2164	Dia 90 - H75cm / H67cm / H35cm		4			
R2162-xx	Bottom plate dia 60cm	1		64x64x7cm 25.25x25.25x2.75"	0.03 1.01	27.00 59.5
R2160H-xx	Tube high <b>H75cm</b>	1		73x10x10cm 28.75x4x4"	0.01 0.26	4.45 9.8
R2160M-xx	Tube medium <b>H67cm</b>	1		67x10x10cm 26.5x4x4"	0.01 0.24	4.00 8.8
R2160L-xx	Tube low <b>H35cm</b>	1		34x20x15cm 13.5x7.75x6"	0.01 0.36	2.05 4.5
R2163-xx	Top plate	1		44x44x6cm 17.25x17.25x2.25"	0.01 0.41	6.40 14.1
S2160-Cxx	Ceramic top dia 90cm	1		100x100x6cm 39.25x39.25x2.25"	0.06 2.12	21.00 46.3
S2160-Lxx	Lavastone top dia 90cm	1		106x106x6cm 41.75x41.75x2.25"	0.07 2.38	41.85 92.3
W2187	Teak top dia 90cm	1		96x96x8cm 37.75x37.75x3.25"	0.07 2.60	17.00 37.5
D2162 / D2163 / D2165	Dia 125 - H75cm / H67cm / H35cm		4			
R2162-xx	Bottom plate dia 60cm	1		64x64x7cm 25.25x25.25x2.75"	0.03 1.01	27.00 59.5



ARTICLE NR.	ARTICLE	BOX. CONTENT	NR. OF BOXES	BOX DIM. (LXDXH)  CM IN	VOLUME  M <sup>3</sup> FT <sup>3</sup>	GROSS WEIGHT BOX  KG LB
R2160H-xx	Tube high H75cm	1		73x10x10cm 28.75x4x4"	0.01 0.26	4.45 9.8
R2160M-xx	Tube medium <b>H67cm</b>	1		67x10x10cm 26.5x4x4"	0.01 0.24	4.00 8.8
R2160L-xx	Tube low <b>H35cm</b>	1		34x20x15cm 13.5x7.75x6"	0.01 0.36	2.05 4.5
R2163-xx	Top plate	1		44x44x6cm 17.25x17.25x2.25"	0.01 0.41	6.40 14.1
S2162-Cxx	Ceramic top dia 125	1		134x134x7cm 52.75x52.75x2.75"	0.13 4.44	47.00 103.6
S2162-Lxx	Lavastone top dia 125	1		148x148x7cm 58.25x58.25x2.75"	0.15 5.41	80.30 177.1
W2162	Teak top dia 125	1		131x131x7cm 51.5x51.5x2.75"	0.12 4.24	31.00 68.4
D2170 / D2172 / D2174	90x90 - H75cm / H67cm / H35cm		4			
R2162-xx	Bottom plate dia 60cm	1		64x64x7cm 25.25x25.25x2.75"	0.03 1.01	27.00 59.5
R2160H-xx	Tube high <b>H75cm</b>	1		73x10x10cm 28.75x4x4"	0.01 0.26	4.45 9.8
R2160M-xx	Tube medium <b>H67cm</b>	1		67x10x10cm 26.5x4x4"	0.01 0.24	4.00 8.8
R2160L-xx	Tube low <b>H35cm</b>	1		34x20x15cm 13.5x7.75x6"	0.01 0.36	2.05 4.5
R2163-xx	Top plate	1		44x44x6cm 17.25x17.25x2.25"	0.01 0.41	6.40 14.1
S2164-Cxx	Ceramic top 90x90cm	1		100x100x6cm 39.25x39.25x2.25"	0.06 2.12	25.00 55.1
S2164-Lxx	Lavastone top 90x90cm	1		111x111x6cm 43.75x43.75x2.25"	0.07 2.61	50.00 110.3
W2170	Teak top 90x90cm	1		100x100x8cm 39.25x39.25x3.25"	0.08 2.83	20.00 44.1
D2183 / D2184 / D2185	Ellipse 136x80 - H75cm / H67cm / H35cm		4			
R2162-xx	Bottom plate dia 60cm	1		64x64x7cm 25.25x25.25x2.75"	0.03 1.01	27.00 59.5
R2160H-xx	Tube high <b>H75cm</b>	1		73x10x10cm 28.75x4x4"	0.01 0.26	4.45 9.8
R2160M-xx	Tube medium <b>H67cm</b>	1		67x10x10cm 26.5x4x4"	0.01 0.24	4.00 8.8
R2160L-xx	Tube low <b>H35cm</b>	1		34x20x15cm 13.5x7.75x6"	0.01 0.36	2.05 4.5
R2163-xx	Top plate	1		44x44x6cm 17.25x17.25x2.25"	0.01 0.41	6.40 14.1
S2183-Cxx	Ceramic top 136x80cm	1		140x84x6cm 55x33x2.25"	0.07 2.49	25.76 56.8
S2183-Lxx	Lavastone top 136x80cm	1		140x84x6cm 55x33x2.25"	0.07 2.49	52.22 115.1
W2183	Teak top 136x80cm	1		140x84x6cm 55x33x2.25"	0.07 2.49	20.19 44.5
D2175 / D2177 / D2179	240x98 - H75cm / H67cm / H35cm		5			
R2161-xx	Bottom plate dia 47,5cm	2		53x53x7cm 20.75x20.75x2.75"	0.02 0.69	16.00 35.3

ARTICLE NR.	ARTICLE	BOX. CONTENT	NR. OF BOXES	BOX DIM. (LXDXH)	VOLUME	GROSS WEIGHT BOX
				CM IN	M <sup>3</sup> FT <sup>3</sup>	KG LB
R2160H-xx	Tube high <b>H75cm</b>	1		73x10x10cm 28.75x4x4"	0.01 0.26	4.45 9.8
R2160M-xx	Tube medium <b>H67cm</b>	1		67x10x10cm 26.5x4x4"	0.01 0.24	4.00 8.8
R2160L-xx	Tube low <b>H35cm</b>	1		34x20x15cm 13.5x7.75x6"	0.01 0.36	2.05 4.5
R2164-xx	support 240x98cm	1		207x66x8cm 81.5x26x3.25"	0.11 3.86	15.00 33.1
S5355-Cxx	Ceramic top 240x98cm	1		254x112x5cm 100x44x2"	0.14 5.02	73.00 161.0
W2152	Teak top 240x98cm	1		253x112x5cm 99.5x44x2"	0.14 5.00	57.00 125.7
D2176 / D2178 / D2180	298x98 - H75cm / H67cm / H35cm		5			
R2161-xx	Bottom plate dia 47,5cm	2		53x53x7cm 20.75x20.75x2.75"	0.02 0.69	16.00 35.3
R2160H-xx	Tube high <b>H75cm</b>	1		73x10x10cm 28.75x4x4"	0.01 0.26	4.45 9.8
R2160M-xx	Tube medium <b>H67cm</b>	1		67x10x10cm 26.5x4x4"	0.01 0.24	4.00 8.8
R2160L-xx	Tube low <b>H35cm</b>	1		34x20x15cm 13.5x7.75x6"	0.01 0.36	2.05 4.5
R2165-xx	support 298x98cm	1		265x66x6cm 104.25x26x2.25"	0.10 3.71	15.00 33.1
S5354-Cxx	Ceramic top 298x98cm	1		312x112x5cm 122.75x44x2"	0.17 6.17	92.00 202.9
W2154	Teak top 298x98cm	1		312x112x5cm 122.75x44x2"	0.17 6.17	69.00 152.1
<b>TAO TABLES</b>						
01666-xx	Dining table dia 160cm		2			
S1666B-x	Concrete Base dia 160cm/180cm	1		64x65x88cm 25.25x25.5x34.75"	0.37 12.93	115.00 253.6
S1666-x	Concrete top Dia 160cm	1		179x179x18cm 70.5x70.5x7"	0.58 20.37	141.20 311.3
01668-xx	Dining table dia 180cm		2			
S1666B-x	Concrete Base dia 160cm/180cm	1		64x65x88cm 25.25x25.5x34.75"	0.37 12.93	115.00 253.6
S1668-x	Concrete top Dia 180cm	1		198x200x18cm 78x78.75x7"	0.71 25.17	167.00 368.2
01670-xx	Dining table Oval					
S1666B-x	Concrete Base dia 160cm/180cm			64x65x88cm 25.25x25.5x34.75"	0.37 12.93	115.00 253.6
S1670-x	Concrete top - Oval			198x200x18cm 78x78.75x7"	0.71 25.17	141.20 311.3
01682-xx	Coffee table 80x80cm		2			
S1682B-x	Concrete Base 80x80cm	1		58x59x48cm 22.75x23.25x19"	0.16 5.80	38.35 84.6
S1682-x	Concrete top 80x80cm	1		89x90x9cm 35x35.5x3.5"	0.07 2.55	24.65 54.4
<b>TOSCA</b>						
05318-xx	Armchair	2	1	73x61x104cm 28.75x24x41"	0.5 17.7	13 28.7



ARTICLE NR.	ARTICLE	BOX. CONTENT	NR. OF BOXES	BOX DIM. (LXD <sub>X</sub> H)	VOLUME	GROSS WEIGHT BOX
				CM IN	M <sup>3</sup> FT <sup>3</sup>	KG LB
05315-xx	Counter Height Chair	1	1	64x61x95cm 25.25x24x37.5"	0.4 14.1	15 33.1
05317-xx	Low Dining Chair	2	1	80x70x110cm 31.5x27.5x43.25"	0.6 21.2	14 30.9
05302-xx	Lounge chair	1	1	93x79x74cm 36.5x31x29.25"	0.5 17.7	31 68.4
05308-xx	Sofa 2-seater	1	1	168x79x75cm 66.25x31x29.5"	1.0 35.3	43.5 95.9
05309-xx	Sofa 3-seater	1	1	236x79x75cm 93x31x29.5"	1.4 49.4	55.8 123.0
05340-xx	Adjustable lounger	1	1	215x92x30cm 84.75x36.25x11.75"	0.6 21.2	46.4 102.3
05349-xx	Daybed	1	1	190x174x86cm 74.75x68.5x33.75"	2.8 98.9	102.0 224.9
05355-xx	Dining table 98x240 cm		2			
R5355-xx	Frame	1		211x85x8cm 83x33.5x3.25"	0.14 5.07	26.85 59.2
S5355G-xx	Ceramic top	1		254x112x5cm 100x44x2"	0.14 5.02	73.00 161.0
05354-xx	Dining table 98x298 cm		2			
R5354-xx	Frame	1		270x85x9cm 106.25x33.5x3.5"	0.21 7.29	38.70 85.3
S5354G-xx	Ceramic top	1		312x112x5cm 122.75x44x2"	0.17 6.17	92.00 202.9
05335-xx	Low Dining Table 240cm		3			
R5355-xx	Frame	1		211x85x8cm 83x33.5x3.25"	0.14 5.07	26.85 59.2
R5330-xx	Low dining table legs	1		65x22x6cm 25.5x8.75x2.25"	0.01 0.4	7.1 15.7
S5355-xx	Ceramic top	1		254x112x5cm 100x44x2"	0.14 5.02	73.00 161.0
05334-xx	Low Dining Table 298 cm		3			
R5354-xx	Frame	1		270x85x9cm 106.25x33.5x3.5"	0.21 7.29	38.70 85.3
R5330-xx	Low dining table legs	1		65x22x6cm 25.5x8.75x2.25"	0.01 0.4	7.1 15.7
S5354-xx	Ceramic top	1		312x112x5cm 122.75x44x2"	0.17 6.17	92.00 202.9
05381-xx	Side table		2			
R5381-xx	Frame	1		52x46x42cm 20.5x18x16.5"	0.10 3.55	3.95 8.7
S5381G-xx	Ceramic top	1		61x55x4cm 24x21.75x1.5"	0.01 0.47	8.00 17.6
05386-xx	Coffee table		2			
R5386-xx	Frame	1		91x65x35cm 35.75x25.5x13.75"	0.21 7.31	5.65 12.5
S5386G-xx	Ceramic top	1		105x94x4cm 41.25x37x1.5"	0.04 1.39	26.00 57.3
<b>UKIYO</b>						
07518	Armchair	2	1	69x65x91cm 27.25x25.5x35.75"	0.4 14.1	10 22.1

ARTICLE NR.	ARTICLE	BOX. CONTENT	NR. OF BOXES	BOX DIM. (LXD <sub>X</sub> H)	VOLUME	GROSS WEIGHT BOX
				CM IN	M <sup>3</sup> FT <sup>3</sup>	KG LB
07512	Lounge Chair	1	1	82x57x80cm 32.25x22.5x31.5"	0.4 14.1	12.5 27.6
07540	Lounger	1	1	210x79x41cm 82.75x31x16.25"	0.7 24.7	14.3 31.5
07553	Dining Table		2			
W7553	Teak Frame	1		274x108x20cm 107.75x42.5x7.75"	0.59 20.90	42.00 92.6
S2006-Cx	Ceramic Top	1		275x108x8cm 108.25x42.5x3.25"	0.24 8.39	72.00 158.8
W5005	Teak Top	1		270x101x5cm 106.25x39.75x2"	0.14 4.82	34.00 75.0
07586	Coffee Table		2			
W7586	Teak Frame	1		105x105x9cm 41.25x41.25x3.5"	0.10 3.50	12.00 26.5
S2007-Cx	Ceramic Top	1		106x106x5cm 41.75x41.75x2"	0.06 1.98	27.00 59.5
W5002	Teak Top	1		102x102x6cm 40.25x40.25x2.25"	0.06 2.20	15.90 35.1
07588	Low Table		2			
W7588	Teak Frame	1		167x78x11cm 65.75x30.75x4.25"	0.14 5.06	14.00 30.9
S7588-Cx	Ceramic Top	1		170x80x6cm 67x31.5x2.25"	0.08 2.88	35.21 77.6
W7590	Teak Top	1		165x76x6cm 65x30x2.25"	0.08 2.66	17.00 37.5
<b>VIS A VIS</b>						
01718	Armchair	1	1	61x62x90cm 24x24.5x35.5"	0.3 10.6	10.9 24.0
01712	Lounge chair	1	1	73x74x78cm 28.75x29.25x30.75"	0.4 14.1	11.5 25.4
01713	Rocking chair	1	1	84x64x79cm 33x25.25x31"	0.4 14.1	12.5 27.6
01734	Bench		2			
W1734	Top	1		211x113x8cm 83x44.5x3.25"	0.19 6.74	42.30 93.3
W1712	Legs H44cm	1		211x113x8cm 83x44.5x3.25"	0.19 6.74	42.30 93.3
01740	Adjustable lounger	1	1	211x113x8cm 83x44.5x3.25"	0.19 6.74	42.30 93.3
01740W	Set of wheels	1	1	29x27x16cm 11.5x10.75x6.25"	0.01 0.44	3.15 6.9
01741	Adjustable lounger with wheels		2			
W1740	Adjustable lounger	1		211x113x8cm 83x44.5x3.25"	0.19 6.74	42.30 93.3
W1740WH	Set of wheels	1		29x27x16cm 11.5x10.75x6.25"	0.01 0.44	3.15 6.9
01773	Dining table 99x99cm		2			
W1773A	Top	1		104x102x7cm 41x40.25x2.75"	0.07 2.62	33.65 74.2
W1773B	Set of legs	1		77x59x13cm 30.25x23.25x5"	0.06 2.09	9.45 20.8
01753	Dining table 300x99cm		6			
W1773A	Top	1	3	104x102x7cm 41x40.25x2.75"	0.07 2.62	33.65 74.2



ARTICLE NR.	ARTICLE	BOX. CONTENT	NR. OF BOXES	BOX DIM. (LXDHXH)  CM IN	VOLUME  M <sup>3</sup> FT <sup>3</sup>	GROSS WEIGHT BOX  KG LB
W1773B	Set of legs	1	2	77x59x13cm 30.25x23.25x5"	0.06 2.09	9.45 20.8
R1773	Set of support	1	1	176x16x10cm 69.25x6.25x4"	0.03 0.99	20.75 45.8
01754	Dining table 400x99cm		8			
W1773A	Table top	1	4	104x102x7cm 41x40.25x2.75"	0.07 2.62	33.65 74.2
W1773B	Set of legs	1	2	77x59x13cm 30.25x23.25x5"	0.06 2.09	9.45 20.8
R1773	Set of support	1	1	176x16x10cm 69.25x6.25x4"	0.03 0.99	20.75 45.8
R1773 EXT	Set of extension	1	1	122x15x6cm 48x6x2.25"	0.01 0.39	9.75 21.5
01755	Dining table 500x99cm		11			
W1773A	Top	1	5	104x102x7cm 41x40.25x2.75"	0.07 2.62	33.65 74.2
W1773B	Set of legs	1	3	77x59x13cm 30.25x23.25x5"	0.06 2.09	9.45 20.8
R1773	Set of support	1	1	176x16x10cm 69.25x6.25x4"	0.03 0.99	20.75 45.8
R1773EXT	Set of extension	1	2	122x15x6cm 48x6x2.25"	0.01 0.39	9.75 21.5
01756	Dining table 600x99cm		13			
W1773A	Top		6	104x102x7cm 41x40.25x2.75"	0.07 2.62	33.65 74.2
W1773B	Set of legs		3	77x59x13cm 30.25x23.25x5"	0.06 2.09	9.45 20.8
R1773	Set of support		1	176x16x10cm 69.25x6.25x4"	0.03 0.99	20.75 45.8
R1773EXT	Set of extension		3	122x15x6cm 48x6x2.25"	0.01 0.39	9.75 21.5
01757	Dining table 700x99cm		15			
W1773A	Top	1	7	104x102x7cm 41x40.25x2.75"	0.07 2.62	33.65 74.2
W1773B	Set of legs	1	3	77x59x13cm 30.25x23.25x5"	0.06 2.09	9.45 20.8
R1773	Set of support	1	1	176x16x10cm 69.25x6.25x4"	0.03 0.99	20.75 45.8
R1773EXT	Set of extension	1	4	122x15x6cm 48x6x2.25"	0.01 0.39	9.75 21.50
<b>VIS A VIS SOFA</b>						
01792	Pouf module		1			
W1792	Module 99cm	1		111x103x9cm 43.75x40.5x3.5"	0.10 3.63	20.35 44.9
01700	Extension module single		2			
W1792	Module 99cm	1		111x103x9cm 43.75x40.5x3.5"	0.10 3.63	20.35 44.9
R1700L	Cushion brace 83cm	1		90x35x7cm 35.5x13.75x2.75"	0.02 0.78	1.50 3.3
01701R	Corner module right arm		3			
W1792	Module 99cm	1		111x103x9cm 43.75x40.5x3.5"	0.10 3.63	20.35 44.9

ARTICLE NR.	ARTICLE	BOX. CONTENT	NR. OF BOXES	BOX DIM. (LXDHXH)	VOLUME	GROSS WEIGHT BOX
				CM IN	M <sup>3</sup> FT <sup>3</sup>	KG LB
R1700L	Cushion brace 83cm	1		90x35x7cm 35.5x13.75x2.75"	0.02 0.78	1.50 3.3
R1700S	Cushion brace 63cm	1		69x36x7cm 27.25x14.25x2.75"	0.02 0.61	1.35 3.0
01701L	Corner module left arm		3			
W1792	Module 99cm	1		111x103x9cm 43.75x40.5x3.5"	0.10 3.63	20.35 44.9
R1700L	Cushion brace 83cm	1		90x35x7cm 35.5x13.75x2.75"	0.02 0.78	1.50 3.3
R1700S	Cushion brace 63cm	1		69x36x7cm 27.25x14.25x2.75"	0.02 0.61	1.35 3.0
01708	Centre module		1			
W1708	Module 198cm	1		203x109x9cm 80x43x3.5"	0.20 7.03	34.35 75.7
01706L	Extension pouf left		2			
W1708	Module 198cm	1		203x109x9cm 80x43x3.5"	0.20 7.03	34.35 75.7
R1700L	Cushion brace 83cm	1		90x35x7cm 35.5x13.75x2.75"	0.02 0.78	1.50 3.3
01706R	Extension pouf right		2			
W1708	Module 198cm	1		203x109x9cm 80x43x3.5"	0.20 7.03	34.35 75.7
R1700L	Cushion brace 83cm	1		90x35x7cm 35.5x13.75x2.75"	0.02 0.78	1.50 3.3
01728	Extension module double		3			
W1708	Module 198cm	1	1	203x109x9cm 80x43x3.5"	0.20 7.03	34.35 75.7
R1700L	Cushion brace 83cm	1	2	90x35x7cm 35.5x13.75x2.75"	0.02 0.78	1.50 3.3
01738R	Right arm module		4			
W1708	Module 198cm	1	1	203x109x9cm 80x43x3.5"	0.20 7.03	34.35 75.7
R1700L	Cushion brace 83cm	1	2	90x35x7cm 35.5x13.75x2.75"	0.02 0.78	1.50 3.3
R1700S	Cushion brace 63cm	1	1	69x36x7cm 27.25x14.25x2.75"	0.02 0.61	1.35 3.0
01738L	Left arm module		4			
W1708	Module 198cm	1	1	203x109x9cm 80x43x3.5"	0.20 7.03	34.35 75.7
2x R1700L	Cushion brace 83cm	1	2	90x35x7cm 35.5x13.75x2.75"	0.02 0.78	1.50 3.3
R1700S	Cushion brace 63cm	1	1	69x36x7cm 27.25x14.25x2.75"	0.02 0.61	1.35 3.0
01709	2 seater		5			
W1708	Module 198cm	1	1	203x109x9cm 80x43x3.5"	0.20 7.03	34.35 75.7
R1700L	Cushion brace 83cm	1	2	90x35x7cm 35.5x13.75x2.75"	0.02 0.78	1.50 3.3
R1700S	Cushion brace 63cm	1	2	69x36x7cm 27.25x14.25x2.75"	0.02 0.61	1.35 3.0
01704S	Meridienne right short arm		3			
W1708	Module 198cm	1		203x109x9cm 80x43x3.5"	0.20 7.03	34.35 75.7



ARTICLE NR.	ARTICLE	BOX. CONTENT	NR. OF BOXES	BOX DIM. (LXD <sub>X</sub> H)	VOLUME	GROSS WEIGHT BOX
				CM IN	M <sup>3</sup> FT <sup>3</sup>	KG LB
R1700S	Cushion brace 63cm	1		69x36x7cm 27.25x14.25x2.75"	0.02 0.61	1.35 3.0
R1700L	Cushion brace 83cm	1		90x35x7cm 35.5x13.75x2.75"	0.02 0.78	1.50 3.3
01703S	Meridienne left short arm		3			
W1708	Module 198cm	1		203x109x9cm 80x43x3.5"	0.20 7.03	34.35 75.7
R1700S	Cushion brace 63cm	1		69x36x7cm 27.25x14.25x2.75"	0.02 0.61	1.35 3.0
R1700L	Cushion brace 83cm	1		90x35x7cm 35.5x13.75x2.75"	0.02 0.78	1.50 3.3
01704	Meridienne right long arm		3			
W1708	Module 198cm	1		203x109x9cm 80x43x3.5"	0.20 7.03	34.35 75.7
R1700L	Cushion brace 83cm	1		90x35x7cm 35.5x13.75x2.75"	0.02 0.78	1.50 3.3
R1700S	Cushion brace 63cm	1		69x36x7cm 27.25x14.25x2.75"	0.02 0.61	1.35 3.0
01703	Meridienne left long arm		3			
W1708	Module 198cm	1		203x109x9cm 80x43x3.5"	0.20 7.03	34.35 75.7
R1700L	Cushion brace 83cm	1		90x35x7cm 35.5x13.75x2.75"	0.02 0.78	1.50 3.3
R1700S	Cushion brace 63cm	1		69x36x7cm 27.25x14.25x2.75"	0.02 0.61	1.35 3.0
01742	Daybed module		2			
W1708	Module 198cm	1		203x109x9cm 80x43x3.5"	0.20 7.03	34.35 75.7
R1700L	Cushion brace 83cm	1		90x35x7cm 35.5x13.75x2.75"	0.02 0.78	1.50 3.3
01796 B	Border 99cm					
W1796 B	Border 99cm		1	110x26x8cm 43.25x10.25x3.25"	0.02 0.81	9.55 21.1
01797 B						
W1797 B	Border 121cm		1	132x28x6cm 52x11x2.25"	0.02 0.78	11.55 25.5
01700 B	Border		3			
01796B	Border 99cm	1	1	110x26x8cm 43.25x10.25x3.25"	0.02 0.81	9.55 21.1
01797B	Border 121cm	1	2	132x28x6cm 52x11x2.25"	0.02 0.78	11.55 25.5
01701 B	Border		2			
01796B	Border 99cm	1		110x26x8cm 43.25x10.25x3.25"	0.02 0.81	9.55 21.1
01797B	Border 121cm	1		132x28x6cm 52x11x2.25"	0.02 0.78	11.55 25.5
01738 B	Border		3			
01796B	Border 99cm	1	2	110x26x8cm 43.25x10.25x3.25"	0.02 0.81	9.55 21.1
01797B	Border 121cm	1	1	132x28x6cm 52x11x2.25"	0.02 0.78	11.55 25.5
01709 B	Border		4			
01796B	Border 99cm	1	2	110x26x8cm 43.25x10.25x3.25"	0.02 0.81	9.55 21.1

ARTICLE NR.	ARTICLE	BOX. CONTENT	NR. OF BOXES	BOX DIM. (LXD <sub>X</sub> H)	VOLUME	GROSS WEIGHT BOX
				CM IN	M <sup>3</sup> FT <sup>3</sup>	KG LB
01797B	Border 121cm	1	2	132x28x6cm 52x11x2.25"	0.02 0.78	11.55 25.5
01706 B	Border		2			
01796B	Border 99cm	1	2	110x26x8cm 43.25x10.25x3.25"	0.02 0.81	9.55 21.1
01704 B	Border		2			
01797B	Border 121cm	1	2	132x28x6cm 52x11x2.25"	0.02 0.78	11.55 25.5
01781	Coffee table 99x99cm		2			
W1773A	Top coffee table	1		104x102x7cm 41x40.25x2.75"	0.07 2.62	33.65 74.2
W1773C	Legs coffee table	1		27x20x9cm 10.75x7.75x3.5"	0.00 0.17	1.80 4.0
01784	Coffee table 99x121cm	1	1	125x108x9cm 49.25x42.5x3.5"	0.1 3.5	42 92.6
01786	Coffee table 121x121cm	1	1	131x124x9cm 51.5x48.75x3.5"	0.1 3.5	51.6 113.8
01732	Coffee Table 159x40cm		2			
W1734	Top	1		211x113x8cm 83x44.5x3.25"	0.19 6.74	42.30 93.3
W1773C	Legs H18cm	1		27x20x9cm 10.75x7.75x3.5"	0.00 0.17	1.80 4.0
<b>UMBRELLAS</b>						
UA315-xx-xx	Eclipse round dia 350cm	1	1	260x32x30cm 102.25x12.5x11.75"	0.2 7.1	26.6 58.7
UA322-xx-xx	Eclipse square 300x300cm	1	1	268x32x32cm 105.5x12.5x12.5"	0.3 10.6	27.3 60.2
UA323-xx-xx	Eclipse square 350x350cm	1	1	290x32x32cm 114.25x12.5x12.5"	0.3 10.6	30.6 67.5
UW315-xx	Eclipse round dia 350cm	1	1	268x32x32cm 105.5x12.5x12.5"	0.3 10.6	23.2 51.2
UW322-xx	Eclipse square 300x300cm	1	1	269x31x32cm 106x12.25x12.5"	0.3 10.6	24.8 54.7
UW323-xx	Eclipse square 350x350cm	1	1	290x31x31cm 114.25x12.25x12.25"	0.3 10.6	23.7 52.3
<b>BASES</b>						
BG32	Granite base	1	1	61x61x8cm 24x24x3.25"	0.03 1.1	54 119.1
<b>SIDE TABLES</b>						
D5026-x	Drops side table 40cm	1	1	44x45x7cm 17.25x17.75x2.75"	0.01 0.4	5.6 12.3
D5027-x	Drops side table 60cm	1	1	64x64x11cm 25.25x25.25x4.25"	0.05 1.8	11 24.3
D8300	Dunes Side Table		2			
W8300-A	Dunes Teak Base	1		52x26x26cm 20.5x10.25x10.25"	0.04 1.24	11.00 24.3
W8300-B	Dunes Teak Top	1		51x51x8cm 20x20x3.25"	0.02 0.73	4.00 8.8
D8302	Dunes Coffee Table		2			
W8302-A	Dunes Teak Base	1		61x26x26cm 24x10.25x10.25"	0.04 1.46	13.00 28.7



ARTICLE NR.	ARTICLE	BOX. CONTENT	NR. OF BOXES	BOX DIM. (LXD <sub>X</sub> H)	VOLUME	GROSS WEIGHT BOX
				CM IN	M <sup>3</sup> FT <sup>3</sup>	KG LB
W8302-B	Dunes Teak Top	1		61x61x8cm 24x24x3.25"	0.03 1.05	4.00 8.8
D8304	Dunes Low Dining		2			
W8304-A	Dunes Teak Base	1		42x42x64cm 16.5x16.5x25.25"	0.11 3.99	51.11 112.7
W8304-B	Dunes Teak Top	1		96x96x60cm 37.75x37.75x23.5"	0.55 19.53	21.43 47.3
D8102	Roots	1	1	36x38x49cm 14.25x15x19.25"	0.07 2.5	35 77.2
D8103-Lxx	Tairu		2			
W8103	Tairu frame	1		34x34x44cm 13.5x13.5x17.25"	0.05 1.80	7.00 15.4
S8102-Lxx	Lavastone top	1		44x44x4cm 17.25x17.25x1.5"	0.01 0.27	6.00 13.2
D5040-xx	Hexagon low		2			
W5040	Base low	1		71x63x36cm 28x24.75x14.25"	0.16 5.69	13.50 29.8
S5040-Lxx	Glazed lava stone low Muschelkalk Low	1		81x72x5cm 32x28.25x2"	0.03 1.03	18.00 39.7
D5041-xx	Hexagon high		2			
W5041	Base low high	1		50x51x44cm 19.75x20x17.25"	0.11 3.96	11.80 26.0
S5041-Lxx	Glazed lava stone high Muschelkalk High	1		54x60x6cm 21.25x23.5x2.25"	0.02 0.69	10.00 22.1
01285	C-table teak	1	1	44x37x49cm 17.25x14.5x19.25"	0.08 2.8	12.7 28.0
<b>ACCESSORIES</b>						
D5015	Lantern low	1	1	39x39x41cm 15.25x15.25x16.25"	0.06 2.1	8.3 18.3
D5016	Lantern high	1	1	39x39x57cm 15.25x15.25x22.5"	0.09 3.2	10.8 23.8
D5017	Lantern support	1	1	39x40x42cm 15.25x15.75x16.5"	0.07 2.5	8.6 19.0
D09010-89	Luna Lamp	1	1	62x31x23cm 24.5x12.25x9"	0.04 1.4	4 8.8
D3020-x	Gobi Basket - Small	1	1	41x41x32cm 16.25x16.25x12.5"	0.05 1.8	4.3 9.5
D3010-x	Gobi Basket - Large	1	1	61x61x46cm 24x24x18"	0.2 7.1	9.1 20.1
<b>OUTDOOR RUGS</b>						
D2001-200xlength	Rug Loft	1	1	210x30x30cm 82.75x11.75x11.75"	0.2 7.1	depends on length
D2001-250xlength	Rug Loft	1	1	260x30x30cm 102.25x11.75x11.75"	0.2 7.1	
D2003-200xlength	Rug Shindi	1	1	210x30x30cm 82.75x11.75x11.75"	0.2 7.1	depends on length
D2003-300xlength	Rug Shindi	1	1	310x30x30cm 122x11.75x11.75"	0.3 10.6	
<b>MONSIEUR TRICOT LIGHTING</b>						
D080130S / D080130H	Monsieur Lebonnet Stand/Hanging 30cm	1	1	45x45x50cm 17.75x17.75x19.75"	0.1 3.5	5.2 11.5

ARTICLE NR.	ARTICLE	BOX. CONTENT	NR. OF BOXES	BOX DIM. (LXDHX)	VOLUME	GROSS WEIGHT BOX
				CM IN	M <sup>3</sup> FT <sup>3</sup>	KG LB
D080140S / D080140H	Monsieur Lebonnet Stand/Hanging 40cm	1	1	45x45x50cm 17.75x17.75x19.75"	0.1 3.5	6.3 13.9
D080160S / D080160H	Monsieur Lebonnet Stand/Hanging 60cm	1	1	63x55x92cm 24.75x21.75x36.25"	0.3 10.6	11 24.3
D080230S / D080230H	Madame Latoque Stand/Hanging 30cm	1	1	45x45x50cm 17.75x17.75x19.75"	0.1 3.5	5.2 11.5
D080240S / D080240H	Madame Latoque Stand/Hanging 40cm	1	1	45x45x50cm 17.75x17.75x19.75"	0.1 3.5	6 13.2
D080330S / D080330H	Madame Cachet Stand/Hanging 30cm	1	1	45x45x50cm 17.75x17.75x19.75"	0.1 3.5	5.1 11.2
D080340S / D080340H	Madame Cachet Stand/Hanging 40cm	1	1	45x45x50cm 17.75x17.75x19.75"	0.1 3.5	6.3 13.9
D080350S / D080350H	Madame Cachet Stand/Hanging 50cm	1	1	63x55x92cm 24.75x21.75x36.25"	0.3 10.6	7.8 17.2
D080440H	Monsieur Ellipse Hanging 40 cm	1	1	63x55x92cm 24.75x21.75x36.25"	0.3 10.6	7.8 17.2
<b>NOMAD POUFS</b>						
C05032	Nomad pouf dia 61cm	1	1	61x61x49cm 24x24x19.25"	0.2 7.1	6.2 13.7
C05033	Nomad pouf dia 92cm	1	1	92x92x43cm 36.25x36.25x17"	0.4 14.1	10.3 22.7
C05034	Nomad pouf dia 122cm	1	1	122x122x43cm 48x48x17"	0.6 21.2	19.5 43.0
<b>POUFS</b>						
C0009W	Pouf S dia 45cm	1	1	45x45x39cm 17.75x17.75x15.25"	0.08 2.8	1.8 4.0
C0010W	Pouf L dia 60cm	1	1	60x60x42cm 23.5x23.5x16.5"	0.2 7.1	3 6.6
C0011W	Pouf XL dia 90cm	1	1	88x88x34cm 34.75x34.75x13.5"	0.3 10.6	4.8 10.6
<b>MAI POUFS</b>						
05582-x	Mai Pouf - Square	1		110x110x46cm 43.25x43.25x18"	0.6 21.2	20 44.1
05584-x	Mai Pouf - Rectangular	1		110x55x46cm 43.25x21.75x18"	0.3 10.6	12 26.5



ELMINA<sup>®</sup>  
*môj životný štýl*

ELMINA Bratislava | OC LIGHTPARK | Račianska 90 | Bratislava

**[www.elmina.sk](http://www.elmina.sk)** | [elmina@elmina.sk](mailto:elmina@elmina.sk) | +421 910 919 711

Ceny vr. DPH

# TRIBÙ

01/10/2024 - 30/09/2025



# ELMINA<sup>®</sup>

*môj životný štýl*

---

ELMINA Bratislava  
OC Lightpark  
Račianska 90, Bratislava  
tel.: 02/634 522 59  
elmina@elmina.sk  
**www.elmina.sk**

Ceny vr. DPH

## INDEX

L'INDEX - INHOUDSTABEL

	AMANU	8		UMBRELLAS	102
	BRANCH	12		LOW TABLES	
NEW	CESTA	14		ALUMINIUM	103
	CTR	16	NEW	MARE	104
	ELIO	20	NEW	SEREN	105
NEW	ELIO SOFA	22	UPDATED	TEAK	106
	ELIO SOFA SETS	25		ACCESSORIES	108
	FORUM	27		LOFT RUGS	109
UPDATED	ILLUM	28		SHINDI RUGS	109
	KOS	32		MONSIEUR TRICOT HANGING	110
NEW	LUCCA	34		MONSIEUR TRICOT STANDING	111
	MOOD	36	NEW	MONSIEUR TRICOT STANDING WIRED	112
UPDATED	NATAL ALU SOFA REGULAR	42		POUFS	
	NATAL ALU SOFA DEEP	43		POUFS	114
	NATAL ALU SOFA MERIDIENNE	44		NOMAD POUFS	114
	NATAL ALU SOFA SETS	45		MAI POUFS	114
	NATAL ALU X TABLE	48		DECO CUSHIONS	115
	NODI	49		MAINTENANCE PRODUCTS	116
	NODI SOFA REGULAR	50		LOW TABLES OVERVIEW	118
	NODI SOFA DEEP	51		DINING TABLES - BY SIZE	120
	NODI SOFA LOUNGE	52		DINING TABLES - BY MATERIALS	122
	NODI SOFA MERIDIENNE	53		COVERS FOR SOFA'S	123
	NODI SOFA SETS	54		COVERS FOR DINING TABLES	124
	NOMAD	58		COVERS FOR LOW DINING TABLES	125
	NOX	59		COVERS FOR LOW TABLES	127
UPDATED	OTTO	60			
	PAVILION DAYBED	62			
	PURE	65			
	PURE SOFA	67			
	PURE SETS	68			
	SENJA	70			
	SENJA SOFA REGULAR	72			
NEW	SENJA SOFA DEEP	74			
	SENJA SOFA ORGANIC CORNER	76			
	SENJA SOFA MERIDIENNE	77			
	SENJA SOFA SETS	78			
	SURO	82			
	T-TABLE DINING	84			
	T-TABLE LOW DINING	85			
	T-TABLE LOW DINING	86			
	T-TABLE COFFEE	87			
	TAO	88			
	TOSCA	89			
	UKIYO	94			
	VIS À VIS SOFA	97			
	VIS À VIS SOFA SETS	99			



---

TECHNICAL STANDARDS - NORMES TECHNIQUES 130  
 TECHNISCHE NORMEN

CUSHIONS - COUSSINS - KUSSENS

PRICING CUSHIONS	136
FIRE RETARDANT CUSHIONS	137
COLORS	138
FILLINGS	151
FABRIC TYPES	154
SOLUTION DYED ACRYLICS	155
SOLUTION DYED POLYOLEFIN	156
PVC COATED POLYESTER	157
FABRIC PROPERTIES	158
LEGEND FABRIC PROPERTIES	165

MATERIALS - MATÉRIAUX - MATERIALEN

ALUMINIUM	168
BATYLINE®	169
BRASS METAL	170
CANAX®	171
CERAMIC	173
<b>NEW</b> MASS-COLOURED GLASS	174
GLAZED LAVA STONE	175
GRANITE	176
LIGHTENED CONCRETE	177
MONSIEUR TRICOT	180
OUTDOOR RUGS	183
POWDERCOATED STAINLESS STEEL	184
RECYCLED ACRYLIC	185
SYNTHETICS	186
TEXTILENE STRAPS	190
TOSCA WEAVE	191
TRAVERTINE	192
TRICORD®	193
VILEX WEAVE	195
TRIZO WEAVE	196

MAINTENANCE - ENTRETIEN - ONDERHOUD

CLEANING	200
PROTECTING	201
PRODUCTS	202





# 6 LEGEND

## LÉGENDE – LEGENDE

 Stackable  
Empilable  
Stapelbaar

 To assemble  
A monter  
Te monteren



Right arm  
Bras droit  
Rechter arm



Left arm  
Bras gauche  
Linker arm

 Lounger with wheels  
Chaise lounge avec des roues  
Lounger met wielen

### General Information

Dimensions and technical details may be subject to changes without prior notice. Tribù cannot be held responsible for any possible printing errors.

The reproduction of colors may differ from reality.

In the case of the shade of wengé, the designation refers exclusively to the shade and not to the material.

When ordering a sofa configuration that is not shown in the price list, please include a sketch with your order.

Les dimensions et les détails techniques peuvent être sujets à des modifications sans préavis. Tribù n'est pas responsable pour des erreurs d'impression éventuelles.

La représentation des couleurs peut varier de la réalité.

Dans le cas de la teinte wengé, l'appellation se réfère exclusivement à la teinte et non à la matière.

Lors de la commande d'une configuration de canapé qui ne figure pas dans la liste de prix, veuillez envoyer un dessin avec votre commande.

Afmetingen en technische afwerking kunnen gewijzigd worden zonder voorafgaand bericht. Tribù kan niet verantwoordelijk gesteld worden voor eventuele drukfouten.

De weergave van kleuren kan verschillen met de werkelijkheid.

Bij de tint wengé verwijst de aanduiding uitsluitend naar de tint en niet naar het materiaal.

Bij bestelling van een sofaconfiguratie die niet in de prijslijst is weergegeven, gelieve een schets mee te sturen met uw bestelling.

# WARRANTY

## GARANTIE – GARANTIE

### Terms of warranty

A warranty period of 3 years applies to all Tribù branded furniture items and 1 year for cushions, fabrics and protective covers, against all manufacturing and material errors that would affect their use. The warranty commences on the day the product was bought from an official Tribù trading partner (see date on the proof of purchase).

The warranty applies to manufacturing and material errors that occur during normal usage, and not to errors or deficiencies occurring in the course of time or normal usage (wear and tear). Conditions that are not covered by this warranty include – but are not restricted to – colours fading, changes in wood textures, scratches occurring during use, damage resulting from defective maintenance or incorrect use, etc. The warranty does not for example cover discolouration or colours running, cracks, scratches or tears occurring in the varnish due to usage.

### Conditions de garantie

Pour tous les produits de marque Tribù, une période de garantie de 3 ans (1 an pour des coussins, des tissus et des housses de protection) s'applique pour les erreurs de fabrication ou de matériaux qui affecteraient leur usage. La garantie commence le jour où le produit est acheté chez un partenaire commercial officiel de Tribù (cfr date de la preuve d'achat).

La garantie s'applique sur les erreurs de matériaux et de production qui surviennent en cas d'usage normal et non pas d'erreurs ou d'imperfections dues au passage du temps ou à un usage normal (usure). Les éléments non couverts par cette garantie comprennent – mais sans s'y limiter – l'effacement des couleurs, les modifications au niveau des textures du bois, les griffures liées à l'usage, les dégâts causés par un entretien inapproprié ou une mauvaise utilisation, etc. Par exemple, la garantie ne couvre pas la dégradation ou l'effacement des couleurs, les craquelures, les griffures ou les fissures dans le vernis causés par un usage normal.

### Garantievoorwaarden

Voor alle Tribù merkproducten geldt een garantieperiode van 3 jaar (1 jaar voor kussens, stoffen en beschermhoezen) tegen fabrieks- of materiaalfouten die het gebruik ervan zouden beïnvloeden. De garantie begint op de dag dat het product bij een officiële handelspartner van Tribù is aangekocht (cfr datum aankoopbewijs).

De garantie is van toepassing op materiaal- en productiefouten die bij normaal gebruik zijn ontstaan, niet op fouten of onvolkomenheden als gevolg van het verstrijken van de tijd of normaal gebruik (slijtage). Omstandigheden die niet gedekt zijn door deze garantie omvatten - maar zijn niet gelimiteerd tot – vervagen van kleuren, veranderingen in houttexturen, krassen ontstaan door gebruik, schade ten gevolge van gebrekkig onderhoud of verkeerd gebruik, enz. De garantie dekt bijvoorbeeld geen verkleuring of uitlopen van kleuren, barsten, krassen of scheurtjes in lak die ontstaan zijn door gebruik.





Plantation teak from Java  
Teck de plantation de Java  
Plantageteak uit Java

Canax®  
Canax®  
Canax®

Armchair  
Fauteuil repas  
Armstoel

02618-10

€ 1.695



**D2618**  
Cover  
Housse  
Hoes  
€ 200

**C02618SW**  
Seat cushion  
Coussin d'assise  
Zitkussen

D € 220  
E € 290  
F € 335

**C02618W**

Seat & back cushion  
Coussin d'assise et de dossier  
Zit-en rugkussen

D € 445  
E € 595  
F € 695



Lounge chair  
Fauteuil lounge  
Lage stoel

02612-10

€ 2.295



**D2612**  
Cover  
Housse  
Hoes  
€ 260

**C02612W**  
Seat & back cushion  
Coussin d'assise et de dossier  
Zit-en rugkussen

D € 710  
E € 825  
F € 935



Plantation teak from Java  
Teck de plantation de Java  
Plantageteak uit Java

Canax®  
Canax®  
Canax®

## NEW

3-Seater sofa  
Canapé 3 places  
Sofa 3-zit

02609-10

€ 4.990



### D26090

Cover  
Housse  
Hoes  
€ 490

### C02609BSETW

Back cushion Set casual D € 970  
Set de coussin dossier casual E € 1.170  
Rugkussen set casual F € 1.360

### C02609SW

Seat cushion D € 2.640  
Coussin d'assise E € 2.920  
Zitkussen F € 3.185



## NEW

Daybed  
Daybed  
Daybed

02649-10

€ 4.480



### D26490

Cover  
Housse  
Hoes  
€ 400

### C02649W

Seat & back cushion D € 2.285  
Coussin d'assise et de dossier E € 2.665  
Zit-en rugkussen F € 3.035





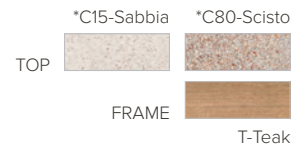

Plantation teak from Java  
Teck de plantation de Java  
Plantageteak uit Java

Table top: ceramic  
Dessus de table: céramique  
Tafelblad: keramiek

\*This colour may possibly show veins  
\*Des veines peuvent éventuellement figurer sur cette couleur  
\*Deze kleur kan mogelijk anders vertonen

**NEW** / Low table dia 90  
Table basse dia 90  
Lage Tafel dia 90

€ 2.750



**NEW** / Low table dia 125  
Table basse dia 125  
Lage Tafel dia 125

€ 3.850

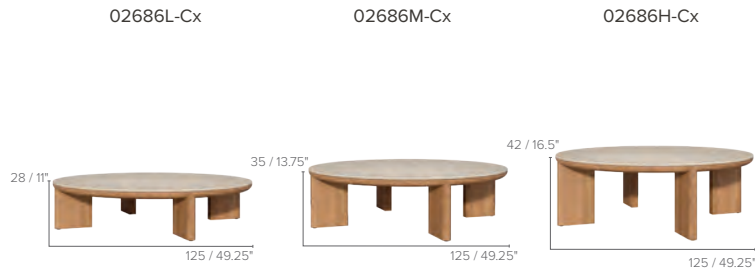

**NEW** / Low table rectangular 155x58cm  
Table basse 155x58cm  
Lage Tafel rechthoekig 155x58cm

€ 3.200



**/** Dining table 290 cm  
Table à manger 290 cm  
Eettafel 290 cm

€ 13.900



**/** Dining table 350 cm  
Table à manger 350 cm  
Eettafel 350 cm

€ 16.950

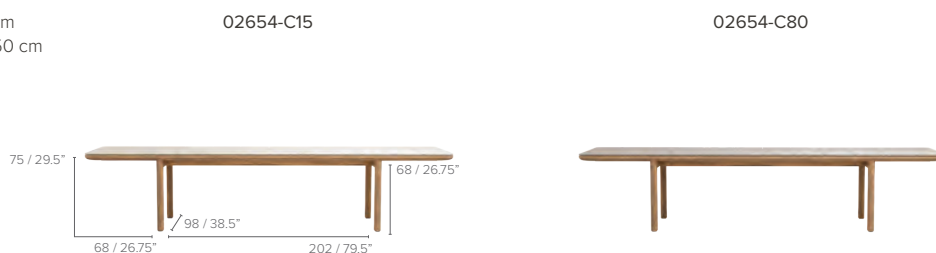

Covers for tables see p.124-127  
Des housses pour les tables voir p.124-127  
Hoezen voor tafels zie p.124-127



---

Plantation teak from Java  
Teck de plantation de Java  
Plantageteak uit Java

---

**NEW**

C-table  
Table-C  
C-tafel

**02685**



€ 1.150 Teak

**D2685**

Cover  
Housse  
Hoes

€ 155



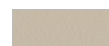

Aluminium, high pressure injected  
Aluminium, moulé sous pression  
Spuitlegaten aluminium

Polypropylene reinforced with glassfiber  
Polypropylène renforcé avec de la fibre de verre  
Polypropyleen versterkt met glasvezel

Batyline  
Batyline  
Batyline

3  
Side chair  
Chaise  
Stoel

€ 650

07610-00-00

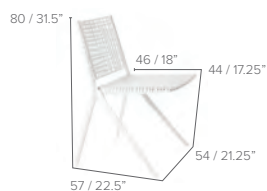

07610-10-10



07610-89-89



**D7610**  
Cover  
Housse  
Hoes  
€ 200

**C07610SW**  
Seat cushion  
Coussin d'assise  
Zitkussen  
D € 140  
E € 175  
F € 185



2  
Armchair  
Fauteuil repas  
Armstoel

€ 765

07618-00-00

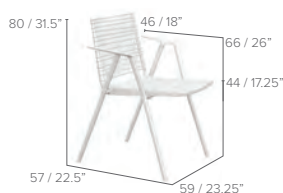

07618-10-10



07618-89-89



**D7618**  
Cover  
Housse  
Hoes  
€ 230

**C07610SW**  
Seat cushion  
Coussin d'assise  
Zitkussen  
D € 140  
E € 175  
F € 185



12  
Adjustable lounger Batyline  
Chaise longue réglable Batyline  
Ligbed, verstelbaar Batyline

€ 2.095

07640-00-00

07640-10-71\*\*  
\*\* 71 Silkgrey

07640-89-89



**D7640**  
Cover  
Housse  
Hoes  
€ 275

**C07640W**  
Cushion  
Coussin  
Kussen  
D € 860  
E € 1.080  
F € 1.325



	T-Teak	00-White	10-Linen	89-Wengé
TOP				
		00-White	10-Linen	89-Wengé
FRAME				

Aluminium, high pressure injected  
Aluminium, moulé sous pression  
Spuitgegoten aluminium

Plantation teak from Java  
Teck de plantation de Java  
Plantageteak uit Java

Table top: aluminium or teak  
Dessus de table: aluminium ou teck  
Tafelblad: aluminium of teak

**Bistro table round**  
Table bistro ronde  
Bistro tafel rond

75 / 29.5"  
72 / 28.25"



€ 1.420

dia 80cm

07660-00-00

07660-10-10

07660-89-89

€ 2.890

dia 125cm

07662-00-00

07662-10-10

07662-89-89

€ 1.180

dia 80cm

07660-00-T

07660-10-T

07660-89-T

€ 2.495

dia 125cm

07662-00-T

07662-10-T

07662-89-T

**Bistro table square**  
Table bistro carrée  
Bistro tafel vierkant

75 / 29.5"  
72 / 28.25"



€ 1.565

80x80cm

07671-00-00

07671-10-10

07671-89-89

€ 1.770

90x90cm

07670-00-00

07670-10-10

07670-89-89

€ 1.425

80x80cm

07671-00-T

07671-10-T

07671-89-T

€ 1.770

90x90cm

07670-00-T

07670-10-T

07670-89-T

**Dining table**  
Table à manger  
Eettafel

75 / 29.5"  
72 / 28.25"



€ 3.490

210x98cm

07652-00-00

07652-10-10

07652-89-89

€ 5.565

300x110cm

07654-00-00

07654-10-10

07654-89-89

€ 4.335

210x98cm

07652-00-T

07652-10-T

07652-89-T

€ 6.250

300x110cm

07654-00-T

07654-10-T

07654-89-T





Aluminium, high pressure injected  
Aluminium, moulé sous pression  
Spuutgegoten aluminium

Canax®  
Canax®  
Canax®

The Cesta chair rotates 360 degrees

Lounge chair, 360° swivel  
Fauteuil lounge, 360° pivotant  
Lage stoel, 360° draaibaar

07712-10-10

€ 2.150



### D7712

Cover  
Housse  
Hoes  
€ 255

### C07712W

Seat & back cushion D € 925  
Coussin d'assise et de dossier E € 1.055  
Zit-en rugkussen F € 1.185







WEAVE

FRAME

10-Linen 89-Wengé

00-White 10-Linen 89-Wengé

Powdercoated stainless steel  
Inox laqué par poudrage  
Gepoedercoat inox

Plaited Tricord (Polyolefin)  
Tricord tressé (Polyoléfine)  
Geweven Tricord (Polyolefine)

Armchair  
Fauteuil repas  
Armstoel

€ 1.395



**D1118**  
Cover  
Housse  
Hoes  
€ 180

**C01118SW**  
Seat cushion  
Coussin d'assise  
Zitkussen  
D € 195  
E € 255  
F € 295



Bar chair  
Tabouret de bar  
Barstoel

€ 1.795



**D1116**  
Cover  
Housse  
Hoes  
€ 275

**C01116SW**  
Seat cushion  
Coussin d'assise  
Zitkussen  
D € 195  
E € 255  
F € 295



Powdercoated stainless steel  
 Inox laqué par poudrage  
 Gepoedercoat inox

Plaited Tricord (Polyolefin)  
 Tricord tressé (Polyoléfine)  
 Geweven Tricord (Polyolefine)



Lounge chair  
 Fauteuil Lounge  
 Lage stoel

€ 2.495



01102-00-10



01102-10-10



01102-89-10



01102-10-89



01102-89-89

**D1102**  
 Cover  
 Housse  
 Hoes  
**€ 230**

**C01100BCAW**  
 Back cushion casual  
 Coussin dossier casual  
 Casual rugkussen  
 D **€ 310**  
 E **€ 340**  
 F **€ 390**

**C01102SW**  
 Seat cushion  
 Coussin d'assise  
 Zitkussen  
 D **€ 385**  
 E **€ 435**  
 F **€ 490**



2-Seater sofa  
 Canapé 2 places  
 Sofa 2-zit

€ 4.295



01108-00-10



01108-10-10



01108-89-10



01108-10-89



01108-89-89

**D1108**  
 Cover  
 Housse  
 Hoes  
**€ 305**

**C01100BCAW**  
 Back cushion Casual  
 Coussin dossier Casual  
 Casual rugkussen  
 Order 2x!  
 D **€ 310**  
 E **€ 340**  
 F **€ 390**

**C01108SW**  
 Seat cushion  
 Coussin d'assise  
 Zitkussen  
 D **€ 1.050**  
 E **€ 1.190**  
 F **€ 1.325**





		10-Linen	89-Wengé
	WEAVE		
FRAME			
	00-White	10-Linen	89-Wengé

Powdercoated stainless steel  
Inox laqué par poudrage  
Gepoedercoat inox

Plaited Tricord (Polyolefin)  
Tricord tressé (Polyoléfine)  
Geweven Tricord (Polyolefine)

**Meridienne right**  
Mériidienne droite  
Rechter meridienne

01104-00-10



€ 6.550

01104-10-10



01104-89-10



01104-10-89



01104-89-89



**D1104**  
Cover  
Housse  
Hoes  
€ 405

**C01100BCAW**  
Back cushion Casual  
Coussin dossier Casual  
Casual rugkussen  
D € 310  
E € 340  
F € 390

**C01104SW**  
Seat cushion  
Coussin d'assise  
Zitkussen  
D € 1.455  
E € 1.545  
F € 1.670



**Meridienne left**  
Mériidienne gauche  
Linker meridienne

01103-00-10



€ 6.550

01103-10-10



01103-89-10



01103-10-89



01103-89-89



**D1103**  
Cover  
Housse  
Hoes  
€ 405

**C01100BCAW**  
Back cushion Casual  
Coussin dossier Casual  
Casual rugkussen  
D € 310  
E € 340  
F € 390

**C01103SW**  
Seat cushion  
Coussin d'assise  
Zitkussen  
D € 1.455  
E € 1.545  
F € 1.670







Plantation teak from Java  
Teck de plantation de Java  
Plantageteak uit Java

Plaited Tricord (polyolefin)  
Tricord tressé (polyoléfine)  
Geweven Tricord (polyolefine)

Armchair  
Fauteuil repas  
Stoel

€ 1.295

02518-10



02518-89



**D2518**  
Cover  
Housse  
Hoes  
€ 180

**C02518SW**  
Seat cushion  
Coussin d'assise  
Zitkussen  
D € 170  
E € 210  
F € 240



Lounge chair  
Fauteuil  
Lage Stoel

€ 2.100

02512-10



02512-89



**D2512**  
Cover  
Housse  
Hoes  
€ 215

**C02512SW**  
Seat cushion  
Coussin d'assise  
Zitkussen  
D € 365  
E € 390  
F € 420



Plantation teak from Java  
Teck de plantation de Java  
Plantageteak uit Java

Plaited Tricord (polyolefin)  
Tricord tressé (polyoléfine)  
Geweven Tricord (polyolefine)

Lounge Chair High Back  
Fauteuil à dossier haut  
Lage Stoel met hoge rug

02520-10



02520-89



€ 2.750

**D2520**  
Cover  
Housse  
Hoes  
€ 230

**C02520W**  
Cushion  
Coussin  
Kussen

D € 1.150  
E € 1.275  
F € 1.395

**C02521BW**

Back cushion  
Coussin dossier  
Rugkussen

D € 440  
E € 465  
F € 500

**C02521SW**

Seat cushion  
Coussin d'assise  
Zitkussen

D € 310  
E € 340  
F € 390



Footrest  
Repose-pieds  
Voetenbankje

02590-10



02590-89



€ 995

**D2590**  
Cover  
Housse  
Hoes  
€ 175

**C02590W**  
Seat cushion  
Coussin d'assise  
Zitkussen

D € 270  
E € 290  
F € 315







Plantation teak from Java  
Teck de plantation de Java  
Plantageteak uit Java

Plaited Tricord (polyolefin)  
Tricord tressé (polyoléfine)  
Geweven Tricord (polyolefine)

## NEW! 1-Seater module

Full backrest  
0350200-10

€ 3.295



**D350200**  
Cover  
Housse  
Hoes  
€ 290

**C03500BW**  
Back cushion  
Coussin dossier  
Rugkussen  
D € 455  
E € 525  
F € 590

**C03502SW**  
Seat cushion  
Coussin d'assise  
Zitkussen  
D € 1.600  
E € 1.775  
F € 1.960



## NEW! Poufs

1-Seater pouf  
03502

€ 2.495



**D3502**  
Cover  
Housse  
Hoes  
€ 240

**C03502SW**  
Seat cushion  
Coussin d'assise  
Zitkussen  
D € 1.600  
E € 1.775  
F € 1.960



2-Seater pouf  
03508

€ 3.495



**D3508**  
Cover  
Housse  
Hoes  
€ 240

**C03508SW**  
Seat cushion  
Coussin d'assise  
Zitkussen  
D € 2.340  
E € 2.600  
F € 2.875



3-Seater pouf  
03509

€ 5.495



**D3509**  
Cover  
Housse  
Hoes  
€ 530

**C03509SW**  
Seat cushion  
Coussin d'assise  
Zitkussen  
D € 3.240  
E € 3.580  
F € 3.955



Daybed pouf  
03549

€ 5.625



**D3549**  
Cover  
Housse  
Hoes  
€ 550

**C03549SW**  
Seat cushion  
Coussin d'assise  
Zitkussen  
D € 3.325  
E € 3.715  
F € 4.160



Plantation teak from Java  
Teck de plantation de Java  
Plantageteak uit Java

Plaited Tricord (polyolefin)  
Tricord tressé (polyoléfine)  
Geweven Tricord (polyolefine)

## NEW 2-Seater modules

Full backrest  
0350800-10

€ 4.765



### C03500BW

Back cushion D € 455  
Coussin dossier E € 525  
Rugkussen F € 590  
(order 2x!)

### C03508SW

Seat cushion D € 2.340  
Coussin d'assise E € 2.600  
Zitkussen F € 2.875

Cover **D350800** € 450



Meridienne left  
0350803-10

€ 4.295



### C03500BW

Back cushion D € 455  
Coussin dossier E € 525  
Rugkussen F € 590  
(order 2x!)

### C03508SW

Seat cushion D € 2.340  
Coussin d'assise E € 2.600  
Zitkussen F € 2.875

Cover **D350803** € 450



Meridienne right  
0350804-10

€ 4.295



### C03500BW

Back cushion D € 455  
Coussin dossier E € 525  
Rugkussen F € 590  
(order 2x!)

### C03508SW

Seat cushion D € 2.340  
Coussin d'assise E € 2.600  
Zitkussen F € 2.875

Cover **D350804** € 450



Extension  
0350828-10

€ 4.095



### C03500BW

Back cushion D € 455  
Coussin dossier E € 525  
Rugkussen F € 590  
(order 2x!)

### C03508SW

Seat cushion D € 2.340  
Coussin d'assise E € 2.600  
Zitkussen F € 2.875

Cover **D350828** € 450



## NEW 3-Seater modules

Full backrest  
0350900-10

€ 6.795



### C03500BW

Back cushion D € 455  
Coussin dossier E € 525  
Rugkussen F € 590  
(order 3x!)

### C03509SW

Seat cushion D € 3.240  
Coussin d'assise E € 3.580  
Zitkussen F € 3.955

Cover **D350900** € 595



Meridienne left  
0350903-10

€ 6.335



### C03500BW

Back cushion D € 455  
Coussin dossier E € 525  
Rugkussen F € 590  
(order 3x!)

### C03509SW

Seat cushion D € 3.240  
Coussin d'assise E € 3.580  
Zitkussen F € 3.955

Cover **D350903** € 595



Meridienne right  
0350904-10

€ 6.335



### C03500BW

Back cushion D € 455  
Coussin dossier E € 525  
Rugkussen F € 590  
(order 3x!)

### C03509SW

Seat cushion D € 3.240  
Coussin d'assise E € 3.580  
Zitkussen F € 3.955

Cover **D350904** € 595







Plantation teak from Java  
Teck de plantation de Java  
Plantageteak uit Java

Plaited Tricord (polyolefin)  
Tricord tressé (polyoléfine)  
Geweven Tricord (polyolefine)

## NEW

## Daybed modules

Full backrest  
0354900-10

€ 6.895



Meridienne left  
0354903-10

€ 6.425



Meridienne right  
0354904-10

€ 6.425



Extension  
0354928-10

€ 6.225

**C03500BW**

Back cushion D € 455  
Coussin dossier E € 525  
Rugkussen F € 590  
(order 2x!)

**C03500BW**

Back cushion D € 455  
Coussin dossier E € 525  
Rugkussen F € 590  
(order 2x!)

**C03500BW**

Back cushion D € 455  
Coussin dossier E € 525  
Rugkussen F € 590  
(order 2x!)

**C03500BW**

Back cushion D € 455  
Coussin dossier E € 525  
Rugkussen F € 590  
(order 2x!)

**C03549SW**

Seat cushion D € 3.325  
Coussin d'assise E € 3.715  
Zitkussen F € 4.160

**C03549SW**

Seat cushion D € 3.325  
Coussin d'assise E € 3.715  
Zitkussen F € 4.160

**C03549SW**

Seat cushion D € 3.325  
Coussin d'assise E € 3.715  
Zitkussen F € 4.160

**C03549SW**

Seat cushion D € 3.325  
Coussin d'assise E € 3.715  
Zitkussen F € 4.160

## Cover

**D354900** € 620

**D354903** € 620

**D354904** € 620

**D354928** € 620



Combination examples  
Exemples de combinaisons  
Combinatievoorbeelden

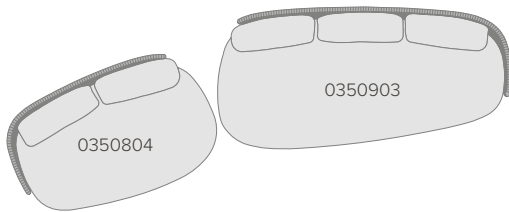

SET 1

Frame: 0350804 + 0350903  
Cushions: 5x C03500BW + C03508SW + C03509SW  
Covers: D350804 + D350903

Total price without covers: Cat.D € 18.485 E € 19.435 F € 20.410

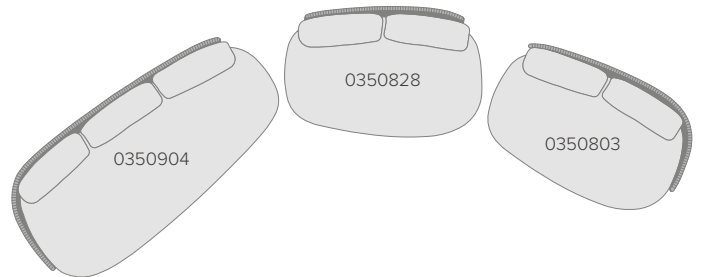

SET 2

Frame: 0350904 + 0350828 + 0350803  
Cushions: 7x C03500BW + C03509SW + 2x C03508SW  
Covers: D350904 + D0350828 + D350803

Total price without covers: Cat.D € 25.830 E € 27.180 F € 28.560

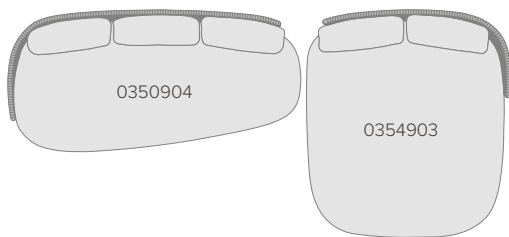

SET 3

Frame: 0350904 + 0354903  
Cushions: 5x C03500BW + C03509SW + C03549SW  
Covers: D350904 + D354903

Total price without covers: Cat.D € 21.600 E € 22.680 F € 23.825

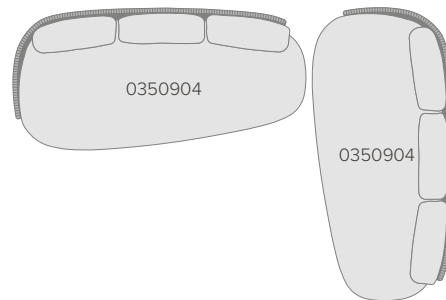

SET 4

Frame: 2x 0350904  
Cushions: 6x C03500BW + 2x C03509SW  
Covers: 2x D350904

Total price without covers: Cat.D € 21.880 E € 22.980 F € 24.120

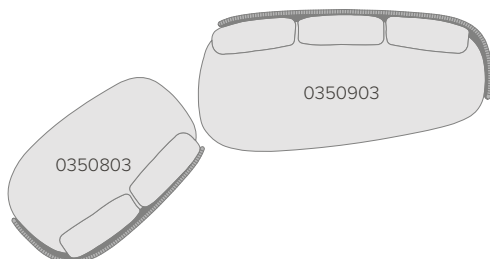

SET 5

Frame: 0350803 + 0350903  
Cushions: 5x C03500BW + C03508SW + C03509SW  
Covers: D350803 + D350903

Total price without covers: Cat.D € 18.485 E € 19.435 F € 20.410

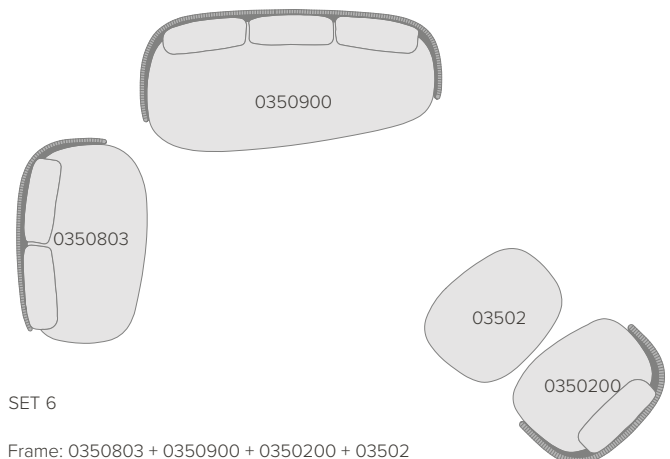

SET 6

Frame: 0350803 + 0350900 + 0350200 + 03502  
Cushions: 6x C03500BW + C03508SW + C03509SW + 2x C03502SW  
Covers: D350903 + D350900 + D350200 + D3502

Total price without covers: Cat.D € 28.390 E € 29.760 F € 31.170





Powdercoated aluminium  
Aluminium peint par poudrage  
Gepoedercoat aluminium

Batyline  
Batyline  
Batyline

\* 71-Canatex silkgrey  
\* 71-Canatex silkgrey  
\* 71-Canatex silkgrey

Adjustable lounger  
Chaise longue réglable  
Ligbed, verstelbaar

€ 1.295

06040-10-71S\*



06040-89-89S



**D6140**  
Cover  
Housse  
Hoes  
€ 255

**C06040W**  
Cushion  
Coussin  
Kussen

D € 550  
E € 725  
F € 930





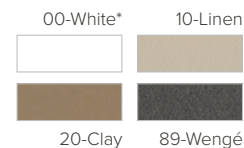

Aluminium, high pressure injected  
Aluminium, moulé sous pression  
Spuitgegoten aluminium

Batyline  
Batyline  
Batyline

\* Only for Armchair  
\* Seulement pour le fauteuil  
\* Alleen voor Armchair

<sup>3</sup> Armchair  
Fauteuil repas  
Armstoel

€ 675



06518-10



06518-20



06518-89



**D6518**

Cover  
Housse  
Hoes  
€ 175

**C06518SW**

Seat cushion  
Coussin d'assise  
Zitkussen

D € 150  
E € 175  
F € 195

**C06518W**

Seat & back cushion  
Coussin d'assise et de dossier  
Zit-en rugkussen

D € 330  
E € 415  
F € 525



**NEW** <sup>3</sup> Lounge chair  
Fauteuil lounge  
Lage Stoel

€ 1.095



06512-10



06512-89



**D6512**

Cover  
Housse  
Hoes  
€ 240

**C06512BW**

Back cushion  
Coussin dossier  
Rugkussen

D € 165  
E € 205  
F € 250

**C06512SW**

Seat cushion  
Coussin d'assise  
Zitkussen

D € 240  
E € 310  
F € 380



Aluminium, high pressure injected  
Aluminium, moulé sous pression  
Spuitgegoten aluminium

Batyline  
Batyline  
Batyline

Plantation teak from Java  
Teck de plantation de Java  
Plantageteak uit Java

 Bench, teak seat  
Banc, siège en teck  
Bank, zit in teak

€ 1.990

06534-00



06534-10



06534-89



**D6534**  
Cover  
Housse  
Hoes  
€ 245

**C07434W**

Cushion\* D € 120  
Coussin\* E € 150  
Kussen\* F € 180  
\*42 x 42 cm, order 4x!



 Adjustable lounger  
Chaise longue réglable  
Ligbed, verstelbaar

€ 2.800

06540-00

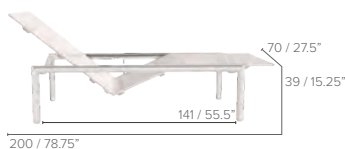

06540-10



06540-89



**D6540**  
Cover  
Housse  
Hoes  
€ 355

**C06540W**

Cushion D € 665  
Coussin E € 780  
Kussen F € 1.035







	10-Linen	*C15-Sabbia	89-Piombo	T-Teak
TOP				
FRAME				

Aluminium, high pressure injected  
Aluminium, moulé sous pression  
Spuitgegoten aluminium

Plantation teak from Java  
Teck de plantation de Java  
Plantageteak uit Java

\*\*Not for counter height table  
\*\*Pas pour la table hauteur de comptoir  
\*\*Niet voor tafel aanrethoogte

\*This colour may possibly show veins  
\*Des veines peuvent éventuellement figurer sur cette couleur  
\*Deze kleur kan mogelijk anders vertonen



Dining table  
Table à manger  
Eettafel

€ 1.960	100x100cm	06573-00-x	06573-10-x	06573-89-x
€ 2.880	152x100cm	06550-00-x	06550-10-x	06550-89-x
€ 3.580	212x100cm	06552-00-x	06552-10-x	06552-89-x
€ 5.190	267x100cm	06554-00-x	06554-10-x	06554-89-x
€ 1.960	100x100cm	06573-00-T	06573-10-T	06573-89-T
€ 2.880	152x100cm	06550-00-T	06550-10-T	06550-89-T
€ 4.750	212x100cm	06552-00-T	06552-10-T	06552-89-T
€ 5.990	267x100cm	06554-00-T	06554-10-T	06554-89-T
€ 3.280	212x71cm	06552xs-00-x	06552xs-10-x	06552xs-89-x
€ 5.190	267x71cm	06554xs-00-x	06554xs-10-x	06554xs-89-x
€ 3.990	212x71cm	06552xs-00-T	06552xs-10-T	06552xs-89-T
€ 4.990	267x71cm	06554xs-00-T	06554xs-10-T	06554xs-89-T



Dining table teak  
Table à manger teck  
Eettafel teak

€ 2.810	100x100cm	06573-T-x
€ 3.935	152x100cm	06550-T-x
€ 4.895	212x100cm	06552-T-x
€ 6.350	267x100cm	06554-T-x
€ 2.810	100x100cm	06573-T-T
€ 3.935	152x100cm	06550-T-T
€ 6.065	212x100cm	06552-T-T
€ 7.150	267x100cm	06554-T-T
€ 5.190	212x73cm	06552XS-T-x
€ 5.900	212x73cm	06552XS-T-T

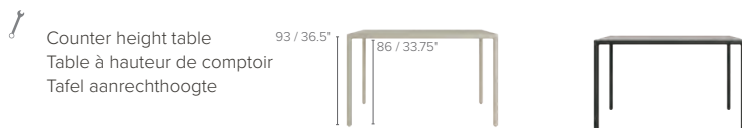

Counter height table  
Table à hauteur de comptoir  
Tafel aanrethoogte

€ 2.930	152x100cm	06560-10-xx	06560-89-xx
€ 3.330	212x71cm	06564XS-10-xx	06564XS-89-xx
€ 2.930	152x100cm	06560-10-T	06560-89-T
€ 4.040	212x71cm	06564XS-10-T	06564XS-89-T

Note: the height and clearance under the table may differ according to the type of table top. Please consult the product sheet on our website.

Remarque: la hauteur et le dégagement sous la table peuvent différer selon le type de dessus de table. Pour plus de détails, consultez la fiche produit sur notre site internet.

Opmerking: afhankelijk van het type tafelblad kunnen de hoogte en de vrije ruimte onder de tafel verschillen. Details vindt u op de productfiche op onze website.

Covers for tables see p.124-127  
Des housses pour les tables voir p.124-127  
Hoezen voor tafels zie p.124-127



Plantation teak from Java  
Teck de plantation de Java  
Plantageteak uit Java

\* Cushion with overstitched pattern  
\* Modèle coussin avec coutures sellier  
\* Kussen met doorstikt patroon

<sup>3</sup> Armchair  
Fauteuil repas  
Armstoel

€ 1.195

04018



**D4018**  
Cover  
Housse  
Hoes  
€ 200

**C04018SW**

Seat cushion\* D € 175  
Coussin d'assise\* E € 220  
Zitkussen\* F € 270



<sup>3</sup> Lounge Chair  
Fauteuil  
Lage stoel

€ 1.395

04012



**D6038**  
Cover  
Housse  
Hoes  
€ 135

**C04012SW**

Seat cushion\* D € 195  
Coussin d'assise\* E € 300  
Zitkussen\* F € 355



Bar chair  
Tabouret de bar  
Barstoel

€ 995

04016



**D4016**  
Cover  
Housse  
Hoes  
€ 200

**C04016SW**

Seat cushion\* D € 170  
Coussin d'assise\* E € 200  
Zitkussen\* F € 225



Plantation teak from Java  
Teck de plantation de Java  
Plantageteak uit Java

⊖ Lounger, adjustable  
Chaise longue réglable  
Ligbed, verstelbaar

04040

€ 2.450

**D6037**

Cover  
Housse  
Hoes  
€ 185

**C04040W**

Cushion\* D € 735  
Coussin\* E € 890  
Kussen\* F € 1.140



⌘ Dining Table  
Table à manger  
Eettafel



€ 2.765 98x98cm  
€ 4.355 224x100cm  
€ 5.670 266x100cm  
€ 7.930 308x110cm

04073

04052  
04053  
04054



NEW

FRAME



Aluminium, high pressure injected  
Aluminium, moulé sous pression  
Sputgegoten aluminium

Batyline  
Batyline  
Batyline

Tricord Waves  
Tricord Waves  
Tricord Waves

Armchair  
Fauteuil repas  
Armstoel

03218-10-10

03218-20-10

03218-89-89

€ 890

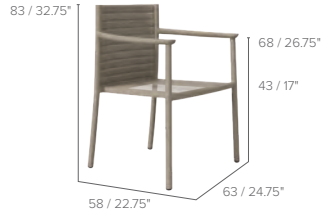
**D3218**

Cover  
Housse  
Hoes  
€ 195

**C03218BW**

Back cushion  
Coussin dossier  
Rugkussen

D € 145  
E € 165  
F € 210

**C03218SW**

Seat cushion  
Coussin d'assise  
Zitkussen

D € 155  
E € 195  
F € 230



Lounge Chair  
Fauteuil lounge  
Lage stoel

03212-10-10

03212-20-10

03212-89-89

€ 1.745

**D3212**

Cover  
Housse  
Hoes  
€ 240

**C03212BW**

Back cushion  
Coussin dossier  
Rugkussen

D € 285  
E € 355  
F € 420

**C03212SW**

Seat cushion  
Coussin d'assise  
Zitkussen

D € 390  
E € 550  
F € 705



	*C11-Sienna	*C76-Pebble	*C86-Pompei	35
TOP				
FRAME	10-Linen	20-Clay	89-Wengé	

Aluminium, high pressure injected  
Aluminium, moulé sous pression  
Spuitgegoten aluminium

\*This colour may possibly show veins  
\*Des veines peuvent éventuellement figurer sur cette couleur  
\*Deze kleur kan mogelijk anders vertonen

Dining Table 240x110cm  
Table à manger  
Eettafel

€ 5.550



Dining Table 320x125cm  
Table à manger  
Eettafel

€ 6.800





Plantation teak from Java  
Teck de plantation de Java  
Plantageteak uit Java

Plaited Tricord (polyolefin)  
Tricord tressé (polyoléfine)  
Geweven Tricord (polyolefine)

Armchair  
Fauteuil repas  
Armstoel

€ 1.095



**D6082**  
Cover  
Housse  
Hoes  
€ 180

**C06218BW**  
Lumbar cushion  
Coussin lombaire  
Lendenkussen  
D € 95  
E € 115  
F € 135

**C06218SW**  
Seat cushion  
Coussin d'assise  
Zitkussen  
D € 120  
E € 155  
F € 180



**C06218BHW**  
High back cushion  
Coussin dossier haut  
Hoog rugkussen  
D € 135  
E € 170  
F € 190

**C06218SW**  
Seat cushion  
Coussin d'assise  
Zitkussen  
D € 120  
E € 155  
F € 180



**C06218BCAW**  
Back cushion Casual  
Coussin dossier Casual  
Casual rugkussen  
D € 160  
E € 190  
F € 220

**C06218SW**  
Seat cushion  
Coussin d'assise  
Zitkussen  
D € 120  
E € 155  
F € 180



Bar chair  
Tabouret de bar  
Barstoel

€ 1.360



**D6088**  
Cover  
Housse  
Hoes  
€ 195

**C06218BW**  
Lumbar cushion  
Coussin lombaire  
Lendenkussen  
D € 95  
E € 115  
F € 135

**C06218SW**  
Seat cushion  
Coussin d'assise  
Zitkussen  
D € 120  
E € 155  
F € 180



**C06218BHW**  
High back cushion  
Coussin dossier haut  
Hoog rugkussen  
D € 135  
E € 170  
F € 190

**C06218SW**  
Seat cushion  
Coussin d'assise  
Zitkussen  
D € 120  
E € 155  
F € 180



**C06218BCAW**  
Back cushion Casual  
Coussin dossier Casual  
Casual rugkussen  
D € 160  
E € 190  
F € 220

**C06218SW**  
Seat cushion  
Coussin d'assise  
Zitkussen  
D € 120  
E € 155  
F € 180



Plantation teak from Java  
Teck de plantation de Java  
Plantageteak uit Java

Plaited Tricord (polyolefin)  
Tricord tressé (polyoléfine)  
Geweven Tricord (polyolefine)



Lounge chair  
Fauteuil lounge  
Lage zetel

€ 1.695

06202-10



06202-85



## D6080

Cover  
Housse  
Hoes  
€ 230

### C06202BW

Back cushion  
Coussin dossier  
Rugkussen  
(58x36cm)

D € 230  
E € 270  
F € 315

### C06202SW

Seat cushion  
Coussin d'assise  
Zitkussen

D € 690  
E € 785  
F € 890



### C06202BCAW

Back cushion Casual  
Coussin dossier Casual  
Casual rugkussen

D € 590  
E € 665  
F € 795

### C06202SW

Seat cushion  
Coussin d'assise  
Zitkussen

D € 690  
E € 785  
F € 890





Plantation teak from Java  
Teck de plantation de Java  
Plantageteak uit Java

Plaited Tricord (polyolefin)  
Tricord tressé (polyoléfine)  
Geweven Tricord (polyolefine)



2-Seater sofa  
Canapé 2 places  
Sofa 2-zit

06208-10

06208-85

€ 2.495

**D6085**

Cover  
Housse  
Hoes  
€ 255

**C06208BSETW**

Back cushion Set D € 455  
Set de coussin dossier E € 545  
Rugkussen Set F € 635

**C06208SW**

Seat cushion D € 965  
Coussin d'assise E € 1.115  
Zitkussen F € 1.250

**C06208BCASETW**

Back cushion Casual Set D € 1.085  
Set dossier Casual E € 1.205  
Casual rugkussen Set F € 1.300

**C06208SW**

Seat cushion D € 965  
Coussin d'assise E € 1.115  
Zitkussen F € 1.250



3-Seater sofa  
Canapé 3 places  
Sofa 3-zit

06209-10

06209-85

€ 3.195

**D6081**

Cover  
Housse  
Hoes  
€ 290

**C06209BSETW**

Back cushion Set D € 685  
Set de coussin dossier E € 815  
Rugkussen Set F € 950

**C06209SW**

Seat cushion D € 1.370  
Coussin d'assise E € 1.600  
Zitkussen F € 1.800

**C06209BCASETW**

Back cushion Casual Set D € 1.630  
Set dossier Casual E € 1.800  
Casual rugkussen Set F € 1.950

**C06209SW**

Seat cushion D € 1.370  
Coussin d'assise E € 1.600  
Zitkussen F € 1.800



Plantation teak from Java  
Teck de plantation de Java  
Plantageteak uit Java

Plaited Tricord (polyolefin)  
Tricord tressé (polyoléfine)  
Geweven Tricord (polyolefine)

Daybed  
Daybed  
Daybed

06249-10

06249-85

€ 4.250



**D6083**

Cover  
Housse  
Hoes  
€ 385

**C06249BSETW**

Back cushion Set D € 685  
Set de coussin dossier E € 815  
Rugkussen Set F € 950

**C06249SW**

Seat cushion D € 1.740  
Coussin d'assise E € 1.985  
Zitkussen F € 2.045



**C06249BCASETW**

Back cushion Casual Set D € 1.630  
Set dossier Casual E € 1.800  
Casual rugkussen Set F € 1.950

**C06249SW**

Seat cushion D € 1.740  
Coussin d'assise E € 1.985  
Zitkussen F € 2.045



For optimal comfort, we recommend completing the daybed with deco cushions. (page 115)  
Pour une ambiance confortable, nous recommandons de compléter le daybed avec des coussins déco. (pag. 115)  
Voor een gezellig gevoel, raden wij aan het daybed te vervolledigen met decokussens. (pag. 115)

Lounge bed  
Lounge bed  
Lounge bed

06250-10

06250-85

€ 2.995



**D6087**

Cover  
Housse  
Hoes  
€ 325

**C06250BSETW**

Back cushion Set D € 455  
Set de coussin dossier E € 545  
Rugkussen Set F € 635

**C06250SW**

Seat cushion D € 1.520  
Coussin d'assise E € 1.790  
Zitkussen F € 1.910



For optimal comfort, we recommend completing the daybed with deco cushions. (page 115)  
Pour une ambiance confortable, nous recommandons de compléter le daybed avec des coussins déco. (pag. 115)  
Voor een gezellig gevoel, raden wij aan het daybed te vervolledigen met decokussens. (pag. 115)







Plantation teak from Java  
Teck de plantation de Java  
Plantageteak uit Java

Ottoman  
Ottoman  
Ottoman

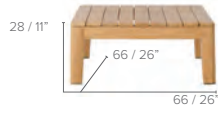

€ 805

06282

**D6096**

Cover  
Housse  
Hoes  
€ 125

**D6096C**

Cover with Cushion  
Housse avec coussin  
Hoes met kussen  
€ 174

**C06282W**

Seat cushion  
Coussin d'assise  
Zitkussen  
66x66cm  
D € 725  
E € 840  
F € 935



Coffee table  
Table de salon  
Koffietafel



€ 805

66x66cm

06282

€ 1.240

120x66cm

06284

**D6096**

Cover 66x66cm  
Housse 66x66cm  
Hoes 66x66cm  
€ 125

**D6108**

Cover 120x66cm  
Housse 120x66cm  
Hoes 120x66cm  
€ 185



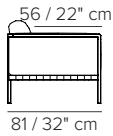
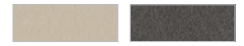

Powdercoated aluminium  
Aluminium peint par poudrage  
Gepoedercoat aluminium

Supporting straps in textile, plaited  
Bandes de support en textile, tressées  
Steunbanden in textileen, gevlochten

## STAND-ALONE

	Armchair	2-Seater sofa	3-Seater sofa	NEW Pouf
Frame	05802-x € 1.245	05808S-x € 1.895	05809S-x € 3.140	05892-x € 940
Cushion	C05802W D € 1.385 E € 1.520 F € 1.710	C05808SHW D € 2.505 E € 2.840 F € 3.095	C05809SHW D € 3.425 E € 3.885 F € 4.290	C05892W D € 740 E € 835 F € 960
Cover	D5802 € 275	D5808SH € 365	D5809SH € 480	D58920 € 240

## MODULAR

Cannot stand alone

	Right arm extension 2-Seater	Right arm corner module 2-Seater	Right corner extension 2-Seater	Centre module 2-Seater
Frame	05838RS-x € 1.895	05848RS-x € 1.895	05858RS-x € 1.895	05828S-x € 1.895
Cushion	C05838RSHW D € 2.340 E € 2.650 F € 3.035	C05848RSHW D € 2.670 E € 3.035 F € 3.445	C05858RSHW D € 2.620 E € 2.865 F € 3.390	C05828SHW D € 2.290 E € 2.480 F € 2.980
	Left arm extension 2-Seater	Left arm corner module 2-Seater	Left corner extension 2-Seater	
Frame	05838LS-x € 1.895	05848LS-x € 1.895	05858LS-x € 1.895	
Cushion	C05838LSHW D € 2.340 E € 2.650 F € 3.035	C05848LSHW D € 2.670 E € 3.035 F € 3.445	C05858LSHW D € 2.620 E € 2.865 F € 3.390	
	Right arm extension 3-Seater	Right arm corner module 3-Seater	Right corner extension 3-Seater	Centre module 3-Seater
Frame	05839RS-x € 3.140	05849RS-x € 3.140	05859RS-x € 3.140	05829S-x € 3.140
Cushion	C05839RSHW D € 3.180 E € 3.585 F € 4.125	C05849RSHW D € 3.510 E € 3.970 F € 4.535	C05859RSHW D € 3.450 E € 3.930 F € 4.465	C05829SHW D € 3.120 E € 3.545 F € 4.055
	Left arm extension 3-Seater	Left arm corner module 3-Seater	Left corner extension 3-Seater	
Frame	05839LS-x € 3.140	05849LS-x € 3.140	05859LS-x € 3.140	
Cushion	C05839LSHW D € 3.180 E € 3.585 F € 4.125	C05849LSHW D € 3.510 E € 3.970 F € 4.535	C05859LSHW D € 3.450 E € 3.930 F € 4.465	



# NATAL ALU SOFA DEEP WIM SEGERS

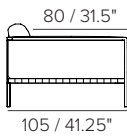

Powdercoated aluminium  
Aluminium peint par poudrage  
Gepoedercoat aluminium

Supporting straps in textile, plaited  
Bandes de support en textile, tressées  
Steunbanden in textileen, gevlochten















Casual back cushions (C02300W) recommended for optimal comfort  
Coussins de dos Casual (C02300W) recommandés pour un confort optimal  
Casual rugkussens (C02300W) aanbevolen voor optimaal comfort

## STAND-ALONE

	 2-Seater sofa 60 / 23.5" 186 / 73.25" 42 / 16.5"	 3-Seater sofa 60 / 23.5" 273 / 107.5" 42 / 16.5"
Frame	05808D-x <b>€ 2.070</b>	05809D-x <b>€ 3.425</b>
Cushion	C05808DW D € 2.880 E € 3.265 F € 3.550	C05809DW D € 3.935 E € 4.465 F € 4.930
Cover	<b>D5808D € 375</b>	<b>D5809D € 550</b>

## MODULAR

Cannot stand alone

	 Right arm extension 2-Seater 188 / 74"	 Right arm corner module 2-Seater	 Right corner extension 2-Seater	 Centre module 2-Seater 186 / 73.25"
Frame	05838RD-x <b>€ 2.070</b>	05848RD-x <b>€ 2.070</b>	05858RD-x <b>€ 2.070</b>	05828D-x <b>€ 2.070</b>
Cushion	C05838RDW D € 2.685 E € 3.045 F € 3.490	C05848RDW D € 3.070 E € 3.480 F € 3.970	C05858RDW D € 3.015 E € 3.285 F € 3.900	C05828DW D € 2.630 E € 2.850 F € 3.420
	 Left arm extension 2-Seater	 Left arm corner module 2-Seater	 Left corner extension 2-Seater	
Frame	05838LD-x <b>€ 2.070</b>	05848LD-x <b>€ 2.070</b>	05858LD-x <b>€ 2.070</b>	
Cushion	C05838LDW D € 2.685 E € 3.045 F € 3.490	C05848LDW D € 3.070 E € 3.480 F € 3.970	C05858LDW D € 3.015 E € 3.285 F € 3.900	
	 Right arm extension 3-Seater 272 / 107"	 Right arm corner module 3-Seater	 Right corner extension 3-Seater	 Centre module 3-Seater 270 / 106.25"
Frame	05839RD-x <b>€ 3.425</b>	05849RD-x <b>€ 3.425</b>	05859RD-x <b>€ 3.425</b>	05829D-x <b>€ 3.425</b>
Cushion	C05839RDW D € 3.660 E € 4.120 F € 4.745	C05849RDW D € 4.045 E € 4.555 F € 5.225	C05859RDW D € 3.970 E € 4.515 F € 5.140	C05829DW D € 3.585 E € 4.080 F € 4.660
	 Left arm extension 3-Seater	 Left arm corner module 3-Seater	 Left corner extension 3-Seater	
Frame	05839LD-x <b>€ 3.425</b>	05849LD-x <b>€ 3.425</b>	05859LD-x <b>€ 3.425</b>	
Cushion	C05839LDW D € 3.660 E € 4.120 F € 4.745	C05849LDW D € 4.045 E € 4.555 F € 5.225	C05859LDW D € 3.970 E € 4.515 F € 5.140	



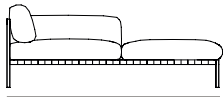
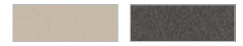

188 / 74"

Powdercoated aluminium  
Aluminium peint par poudrage  
Gepoedercoat aluminium

Supporting straps in textile, plaited  
Bandes de support en textile, tressées  
Steunbanden in textileen, gevlochten

**STAND-ALONE**

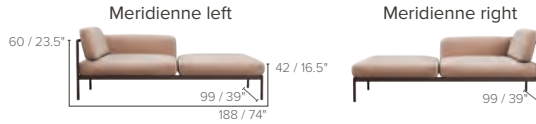

Frame

05868-x  
€ 2.160

05869-x  
€ 2.160

Cushion

C05868W  
D € 2.005  
E € 2.205  
F € 2.650

C05869W  
D € 2.005  
E € 2.205  
F € 2.650

Cover

D5868 € 440

D5869 € 440

**MODULAR**

Cannot stand alone

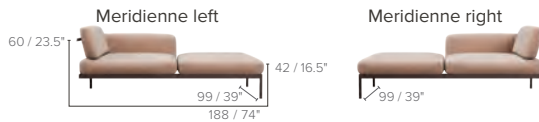

Frame

05803-x  
€ 2.160

05804-x  
€ 2.160

Cushion

C05803W  
D € 2.005  
E € 2.205  
F € 2.650

C05804W  
D € 2.005  
E € 2.205  
F € 2.650

Connector\*

A58C-X

Connecteur\*

Verbindingsstuk\*

€ 65

\*A connector is required to connect two modules lengthwise

\*Un connecteur est nécessaire pour connecter deux modules dans le sens de la longueur

\*Een verbindingsstuk is nodig om twee modules in de lengte met elkaar te verbinden

# NATAL ALU SOFA SETS

WIM SEGERS

10-Linen 89-Wengé

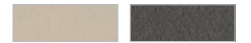

45

Custom covers = 165€ per single seat and 330€ for meridiene and daybed modules  
 Housses sur mesure = 165€ par siège simple et 330€ pour les modules méridienne et daybed  
 Covers op maat = 165€ per enkele zitplaats en 330€ voor meridiene en daybed modules

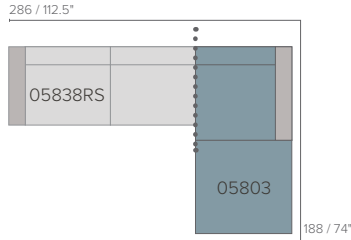

SET 1A  
 Frame: 05838RS + 05803  
 Cushions: C05838RSHW + C05803W

Total Price: Cat.D **€ 8.400** E **€ 8.910** F **€ 9.740**  
 Cover: D5801A **€ 655**

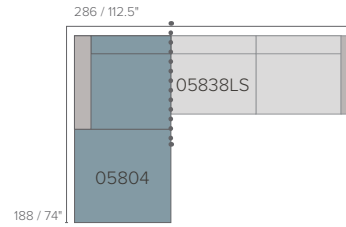

SET 1B  
 Frame: 05838LS + 05804  
 Cushions: C05838LSHW + C05804W

Total Price: Cat.D **€ 8.400** E **€ 8.910** F **€ 9.740**  
 Cover: D5801B **€ 655**

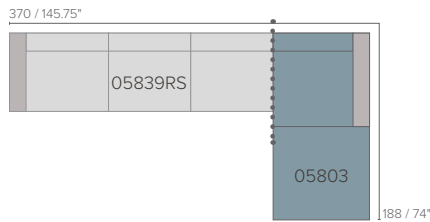

SET 2A  
 Frame: 05839RS + 05803  
 Cushions: C05839RSHW + C05803W

Total Price: Cat.D **€ 10.485** E **€ 11.090** F **€ 12.075**  
 Cover: D5802A **€ 820**

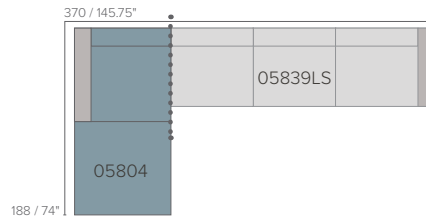

SET 2B  
 Frame: 05839LS + 05804  
 Cushions: C05839LSHW + C05804W

Total Price: Cat.D **€ 10.485** E **€ 11.090** F **€ 12.075**  
 Cover: D5802B **€ 820**

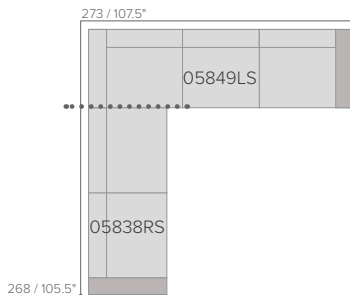

SET 3  
 Frame: 05849LS + 05838RS  
 Cushions: C05849LSHW + C05838RSHW

Total Price: Cat.D **€ 10.885** E **€ 11.655** F **€ 12.605**  
 Cover: D5803 **€ 820**

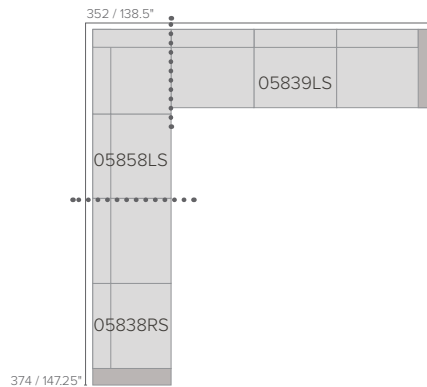

SET 4  
 Frame: 05838RS + 05858LS + 05839LS  
 Cushions: C05838RSHW + C05858LSHW + C05839LSHW  
 Connector: A58C-x

Total Price: Cat.D **€ 15.135** E **€ 16.095** F **€ 17.545**  
 Cover: D5804 **€ 1.145**



Combination examples  
Exemples de combinaisons  
Combinatievoorbeelden

Deep Seat =  Arm Rest =   
Meridienne Seat = 

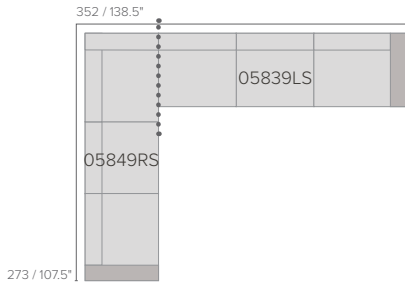

SET 5A  
Frame: 05849RS + 05839LS  
Cushions: C05849RSHW + C05839LSHW  
  
Total Price: Cat.D **€ 12.970 E € 13.835 F € 14.940**  
Cover: D5805A **€ 980**

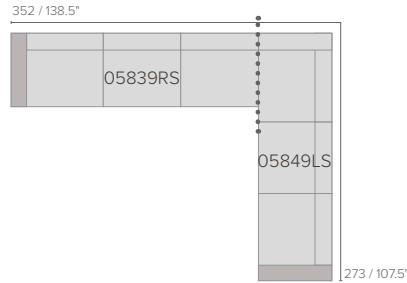

SET 5B  
Frame: 05839RS + 05849LS  
Cushions: C05839RSHW + C05849LSHW  
  
Total Price: Cat.D **€ 12.970 E € 13.835 F € 14.940**  
Cover: D5805B **€ 980**

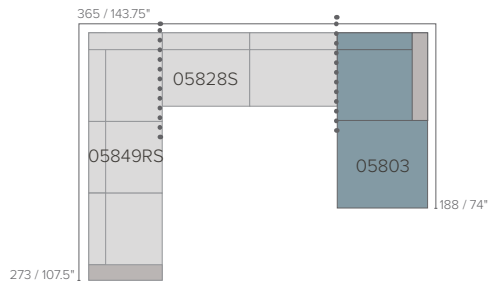

SET 6A  
Frame: 05849RS + 05828S + 05803  
Cushions: C05849RSHW + C05828SHW + C05803W  
  
Total Price: Cat.D **€ 15.000 E € 15.850 F € 17.360**  
Cover: D5806A **€ 1.145**

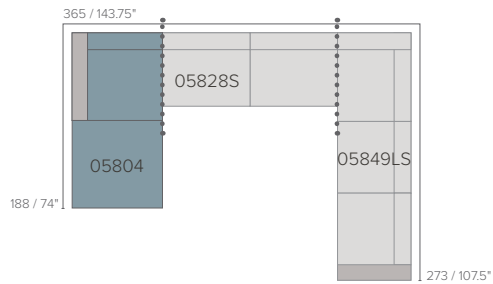

SET 6B  
Frame: 05804 + 05828S + 05849LS  
Cushions: C05804W + C05828SHW + C05849LSHW  
  
Total Price: Cat.D **€ 15.000 E € 15.850 F € 17.360**  
Cover: D5806B **€ 1.145**

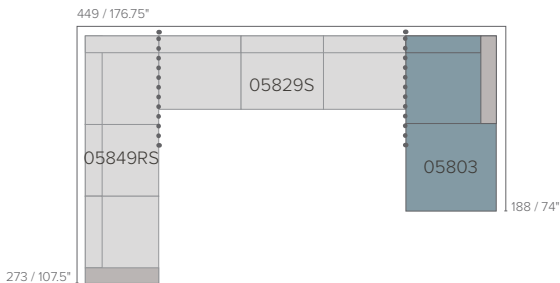

SET 7A  
Frame: 05849RS + 05829S + 05803  
Cushions A: C05849RSHW + C05829SHW + C05803W  
  
Total Price: Cat.D **€ 17.075 E € 18.160 F € 19.680**  
Cover: D5807A **€ 1.310**

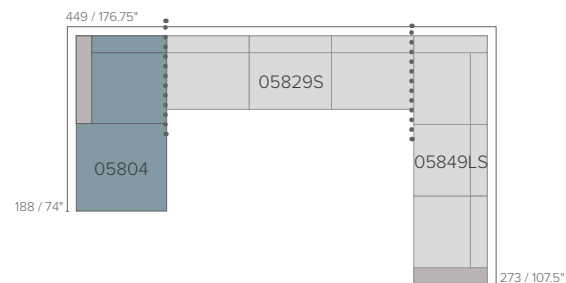

SET 7B  
Frame: 05804 + 05829S + 05849LS  
Cushions: C05804W + C05829SHW + C05849LSHW  
  
Total Price: Cat.D **€ 17.075 E € 18.160 F € 19.680**  
Cover: D5807B **€ 1.310**

Combination examples  
Exemples de combinaisons  
Combinatievoorbeelden

Deep Seat =  Arm Rest =   
Meridienne Seat = 

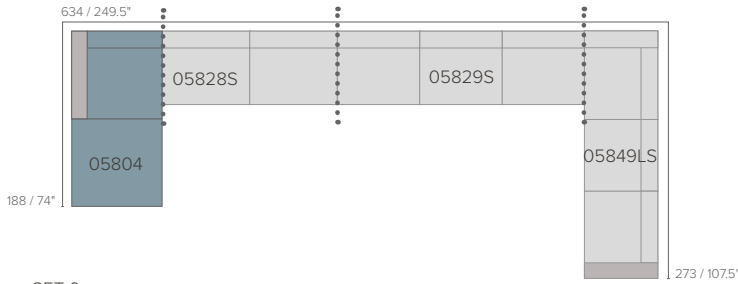

SET 9  
Frame: 05804 + 05828S + 05829S + 05849LS  
Cushions: C05804W + C05828SHW + C05829SHW + C05849LSHW  
Connector: A58C-x

Total Price: Cat.D **€ 21.325** E **€ 22.600** F **€ 24.620**  
Cover: D5809 **€ 1.635**

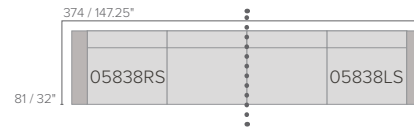

SET 10  
Frame: 05838RS + 05838LS  
Cushions: C05838RSHW + C05838LSHW  
Connector: A58C-x

Total Price: Cat.D **€ 8.535** E **€ 9.155** F **€ 9.925**  
Cover: D5810 **€ 655**

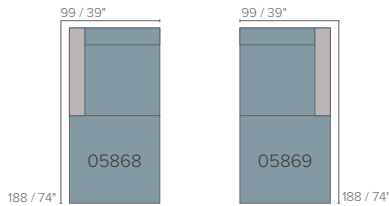

SET 11  
Frame: 05868 + 05869  
Cushions: C05868W + C05869W

Total Price: Cat.D **€ 8.330** E **€ 8.730** F **€ 9.620**  
Cover D5868 + D5869: **€ 440 + € 440 = 880 €**

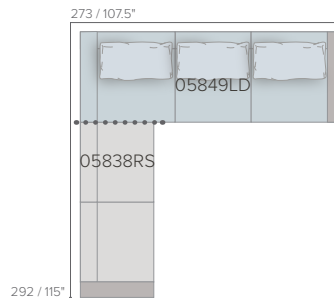

SET 12  
Frame: 05838RS + 05849LD  
Cushions: C05838RSHW + C05849LDW  
Casual back cushion: 3x C02300W

Total Price: Cat.D **€ 12.755** E **€ 13.815** F **€ 15.020**  
Cover: D5812 **€ 820**

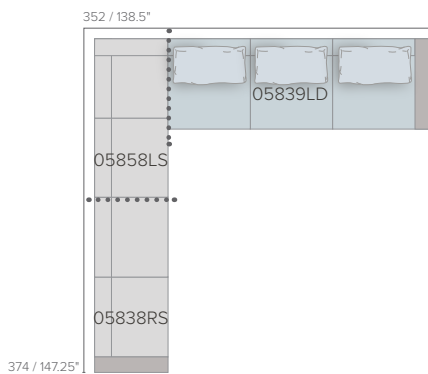

SET 13  
Frame: 05838RS + 05858LS + 05839LD  
Cushions: C05838RSHW + C05858LSHW + C05839LDW  
Casual back cushion: 3x C02300W  
Connector: A58C-x

Total Price: Cat.D **€ 16.950** E **€ 18.205** F **€ 19.890**  
Cover: D5813 **€ 1.145**

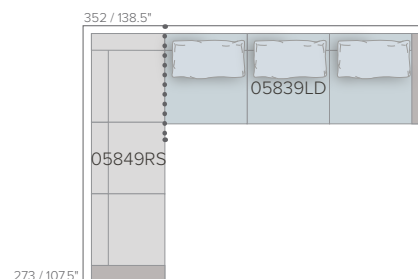

SET 14  
Frame: 05849RS + 05839LD  
Cushions: C05849RSHW + C05839LDW  
Casual back cushion: 3x C02300W

Total Price: Cat.D **€ 14.785** E **€ 15.945** F **€ 17.285**  
Cover: D5814 **€ 980**



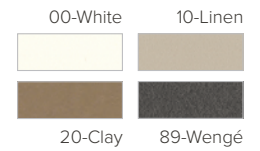

Powdercoated aluminium  
Aluminium laqué par poudrage  
Gepoedercoat aluminium

Coffee table high round  
Table de salon ronde  
Koffietafel hoog rond

€ 575



**D6176**  
Cover  
Housse  
Hoes  
€ 145



Coffee table low 40x40cm  
Table de salon basse 40x40cm  
Koffietafel laag 40x40cm

€ 645

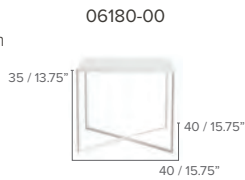

**D6180**  
Cover  
Housse  
Hoes  
€ 165



Coffee table low 60x60cm  
Table de salon basse 60x60cm  
Koffietafel laag 60x60cm

€ 1.050

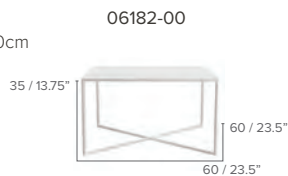

**D6182**  
Cover  
Housse  
Hoes  
€ 180



Powdercoated stainless steel  
Inox laqué par poudrage  
Gepoedercoat inox

Canax®  
Canax®  
Canax®

Armchair  
Fauteuil repas  
Armstoel

€ 1.250

01918-00-00/10



01918-89-10



**D1918**  
Cover  
Housse  
Hoes  
€ 235

**C01918SW**  
Seat cushion      D € 165  
Coussin d'assise      E € 190  
Zitkussen      F € 210



Lounge chair  
Fauteuil  
Lage stoel

€ 1.450

01912-00-00/10



01912-89-10



**D1912**  
Cover  
Housse  
Hoes  
€ 245

**C01912SW**  
Seat cushion      D € 180  
Coussin d'assise      E € 200  
Zitkussen      F € 220



**L** Lounger, adjustable  
Chaise longue, réglable  
Ligbed, verstelbaar

€ 3.600

01940-00-00/10



01940-89-10



**D1940**  
Cover  
Housse  
Hoes  
€ 305

**C01940W**  
Cushion      D € 605  
Coussin      E € 715  
Kussen      F € 830





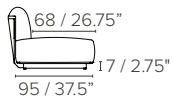
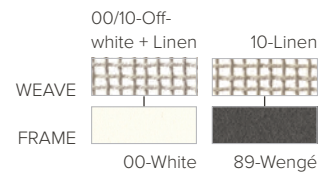

Powdercoated aluminium  
Aluminium peint par poudrage  
Gepoedercoat aluminium

Powdercoated stainless steel  
Inox laqué par poudrage  
Gepoedercoat inox

Canax®  
Canax®  
Canax®

Single module  
Module 1-place  
Enkele module

€ 1.620

01950-00-00/10



01950-89-10



**D1950**  
Cover  
Housse  
Hoes  
€ 240

**C01902BW**  
Back cushion  
Coussin dossier  
Rugkussen  
D € 580  
E € 650  
F € 705

**C01902SW**  
Seat cushion  
Coussin d'assise  
Zitkussen  
D € 1.255  
E € 1.355  
F € 1.450



Corner module  
Module coin  
Hoekmodule

€ 2.250

01951-x-y  
Left arm + Back



01952-x-y  
Right arm + Back



01953-x-y  
Left arm + Corner



01954-x-y  
Right arm + Corner



**C01902BW**  
Back cushion  
Coussin dossier  
Rugkussen  
D € 580  
E € 650  
F € 705

**C01902BW**  
Back cushion  
Coussin dossier  
Rugkussen  
D € 580  
E € 650  
F € 705

**C01901BW**  
Corner Back cushion  
Coussin dossier d'angle  
Hoek rugkussen  
D € 1.130  
E € 1.250  
F € 1.355

**C01901BW**  
Corner Back cushion  
Coussin dossier d'angle  
Hoek rugkussen  
D € 1.130  
E € 1.250  
F € 1.355

**C01902SW**  
Seat cushion  
Coussin d'assise  
Zitkussen  
D € 1.255  
E € 1.355  
F € 1.450

**C01902SW**  
Seat cushion  
Coussin d'assise  
Zitkussen  
D € 1.255  
E € 1.355  
F € 1.450

**C01902SW**  
Seat cushion  
Coussin d'assise  
Zitkussen  
D € 1.255  
E € 1.355  
F € 1.450

**C01902SW**  
Seat cushion  
Coussin d'assise  
Zitkussen  
D € 1.255  
E € 1.355  
F € 1.450

Cover **D1951** € 260



**D1952** € 260



**D1953** € 260



**D1954** € 260



Pouf  
Pouf  
Poef

€ 1.090

01955-00



01955-89

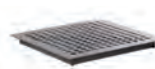

**D1955**  
Cover  
Housse  
Hoes  
€ 195

**C01902SW**  
Seat cushion  
Coussin d'assise  
Zitkussen  
D € 1.255  
E € 1.355  
F € 1.450



Corner Connector\*  
Connecteur d'angle\*  
Hoek Verbindingsstuk\*  
€ 67

\*A connector is needed to create a corner sofa  
\*Un connecteur est nécessaire pour créer un canapé d'angle  
\*Een verbindingsstuk is nodig om een hoek-sofa te vormen

# NODI SOFA DEEP YABU PUSHELBERG

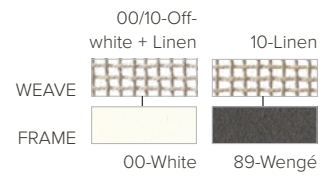

51

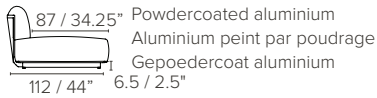

Powdercoated aluminium  
Aluminium peint par poudrage  
Gepoedercoat aluminium

Powdercoated stainless steel  
Inox laqué par poudrage  
Gepoedercoat inox

Canax\*  
Canax\*  
Canax\*

Casual back cushions (C02300W) recommended for optimal comfort  
Coussins de dos Casual (C02300W) recommandés pour un confort optimal  
Casual rugkussens (C02300W) aanbevolen voor optimaal comfort

Single module deep  
Module 1-place profonde  
Enkele module diep

€ 2.225

01960-00-00/10



01960-89-10

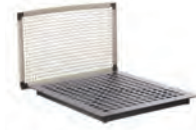

**D1960**  
Cover  
Housse  
Hoes  
€ 255

**C01902BW**  
Back cushion  
Coussin dossier  
Rugkussen

D € 580  
E € 650  
F € 705

**C01903SW**  
Seat cushion  
Coussin d'assise  
Zitkussen

D € 1.450  
E € 1.570  
F € 1.680

**C02300W**

Option Casual back cushion  
Option Coussin dossier Casual  
Optie Casual Rugkussen

D € 350  
E € 430  
F € 480



Corner module deep  
Module coin profonde  
Hoekmodule diep

€ 2.650

01961-x-y  
Left arm + Back



01962-x-y  
Right arm + Back



01963-x-y  
Left arm + Corner



01964-x-y  
Right arm + Corner

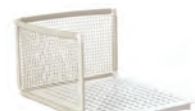

**C01902BW**  
Back cushion  
Coussin dossier  
Rugkussen

D € 580  
E € 650  
F € 705

**C01902BW**  
Back cushion  
Coussin dossier  
Rugkussen

D € 580  
E € 650  
F € 705

**C01901BW**  
Corner Back cushion  
Coussin dossier d'angle  
Hoek rugkussen

D € 1.130  
E € 1.250  
F € 1.355

**C01901BW**  
Corner Back cushion  
Coussin dossier d'angle  
Hoek rugkussen

D € 1.130  
E € 1.250  
F € 1.355

**C01903SW**  
Seat cushion  
Coussin d'assise  
Zitkussen

D € 1.450  
E € 1.570  
F € 1.680

**C01903SW**  
Seat cushion  
Coussin d'assise  
Zitkussen

D € 1.450  
E € 1.570  
F € 1.680

**C01903SW**  
Seat cushion  
Coussin d'assise  
Zitkussen

D € 1.450  
E € 1.570  
F € 1.680

**C01903SW**  
Seat cushion  
Coussin d'assise  
Zitkussen

D € 1.450  
E € 1.570  
F € 1.680

Cover **D1961** € 305



**D1962** € 305



**D1963** € 305



**D1964** € 305



Pouf deep  
Pouf profonde  
Poef diep

€ 1.690

01965-00



01965-89

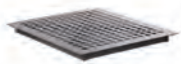

**D1965**  
Cover  
Housse  
Hoes  
€ 205

**C01903SW**  
Seat cushion  
Coussin d'assise  
Zitkussen

D € 1.450  
E € 1.570  
F € 1.680



Corner Connector\*  
Connecteur d'angle\*  
Hoek Verbindingsstuk\* € 67

\*A connector is needed to create a corner sofa  
\*Un connecteur est nécessaire pour créer un canapé d'angle  
\*Een verbindingsstuk is nodig om een hoek-sofa te vormen



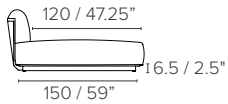
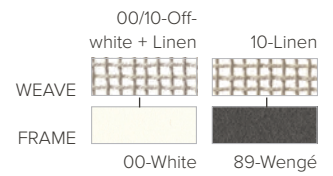

Powdercoated aluminium  
 Aluminium peint par poudrage  
 Gepoedercoat aluminium

Powdercoated stainless steel  
 Inox laqué par poudrage  
 Gepoedercoat inox

Canax®  
 Canax®  
 Canax®

Lounge daybed  
 Lounge daybed  
 Lounge daybed

€ 2.290

01970-00-00/10



01970-89-10



**D1970**  
 Cover  
 Housse  
 Hoes  
**€ 300**

**C01902BW**

Back cushion  
 Coussin dossier  
 Rugkussen

D **€ 580**  
 E **€ 650**  
 F **€ 705**

**C01904SW**

Seat cushion  
 Coussin d'assise  
 Zitkussen

D **€ 1.900**  
 E **€ 2.045**  
 F **€ 2.195**



Lounge corner  
 Lounge coin  
 Lounge hoek

€ 2.730

01971-x-y  
 Left arm + Back



01972-x-y  
 Right arm + Back



01973-x-y  
 Left arm + Corner

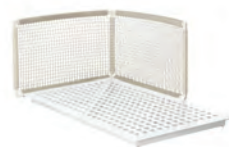

01974-x-y  
 Right arm + Corner



**C01902BW**  
 Back cushion  
 Coussin dossier  
 Rugkussen

D **€ 580**  
 E **€ 650**  
 F **€ 705**

**C01902BW**  
 Back cushion  
 Coussin dossier  
 Rugkussen

D **€ 580**  
 E **€ 650**  
 F **€ 705**

**C01901BW**  
 Corner Back cushion  
 Coussin dossier d'angle  
 Hoek rugkussen

D **€ 1.130**  
 E **€ 1.250**  
 F **€ 1.355**

**C01901BW**  
 Corner Back cushion  
 Coussin dossier d'angle  
 Hoek rugkussen

D **€ 1.130**  
 E **€ 1.250**  
 F **€ 1.355**

**C01904SW**  
 Seat cushion  
 Coussin d'assise  
 Zitkussen

D **€ 1.900**  
 E **€ 2.045**  
 F **€ 2.195**

**C01904SW**  
 Seat cushion  
 Coussin d'assise  
 Zitkussen

D **€ 1.900**  
 E **€ 2.045**  
 F **€ 2.195**

**C01904SW**  
 Seat cushion  
 Coussin d'assise  
 Zitkussen

D **€ 1.900**  
 E **€ 2.045**  
 F **€ 2.195**

**C01904SW**  
 Seat cushion  
 Coussin d'assise  
 Zitkussen

D **€ 1.900**  
 E **€ 2.045**  
 F **€ 2.195**



Pouf lounge  
 Pouf lounge  
 Lounge poef

€ 1.760

01975-00



01975-89

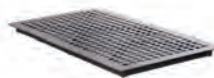

**D1975**  
 Cover  
 Housse  
 Hoes  
**€ 215**

**C01904SW**  
 Seat cushion  
 Coussin d'assise  
 Zitkussen

D **€ 1.900**  
 E **€ 2.045**  
 F **€ 2.195**



# NODI SOFA MERIDIENNE YABU PUSHELBERG

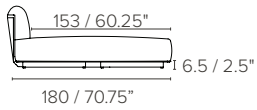
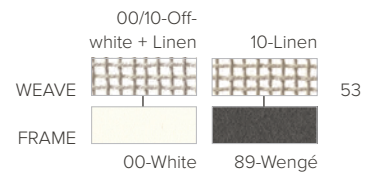

Powdercoated aluminium  
Aluminium peint par poudrage  
Gepoedercoat aluminium

Powdercoated stainless steel  
Inox laqué par poudrage  
Gepoedercoat inox

Canax®  
Canax®  
Canax®

Meridienne daybed  
Meridienne daybed  
Meridienne daybed

€ 2.705

01980-00-00/10



01980-89-10



**D1980**  
Cover  
Housse  
Hoes  
€ 330

**C01902BW**  
Back cushion  
Coussin dossier  
Rugkussen

D € 580  
E € 650  
F € 705

**C01905SW**  
Seat cushion  
Coussin d'assise  
Zitkussen

D € 2.275  
E € 2.455  
F € 2.635



Meridienne corner  
Meridienne coin  
Meridienne hoek

€ 3.135

01981-x-y  
Left arm + back



01982-x-y  
Right arm + Back



01983-x-y  
Left arm + Corner



01984-x-y  
Right arm + Corner



**C01902BW**  
Back cushion  
Coussin dossier  
Rugkussen

D € 580  
E € 650  
F € 705

**C01902BW**  
Back cushion  
Coussin dossier  
Rugkussen

D € 580  
E € 650  
F € 705

**C01901BW**  
Corner Back cushion  
Coussin dossier d'angle  
Hoek rugkussen

D € 1.130  
E € 1.250  
F € 1.355

**C01901BW**  
Corner Back cushion  
Coussin dossier d'angle  
Hoek rugkussen

D € 1.130  
E € 1.250  
F € 1.355

**C01905SW**  
Seat cushion  
Coussin d'assise  
Zitkussen

D € 2.275  
E € 2.455  
F € 2.635

**C01905SW**  
Seat cushion  
Coussin d'assise  
Zitkussen

D € 2.275  
E € 2.455  
F € 2.635

**C01905SW**  
Seat cushion  
Coussin d'assise  
Zitkussen

D € 2.275  
E € 2.455  
F € 2.635

**C01905SW**  
Seat cushion  
Coussin d'assise  
Zitkussen

D € 2.275  
E € 2.455  
F € 2.635



Pouf XL  
Pouf XL  
Poef XL

€ 2.175

01985-00



01985-89

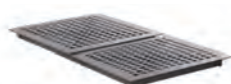

**D1985**  
Cover  
Housse  
Hoes  
€ 220

**C01905SW**  
Seat cushion  
Coussin d'assise  
Zitkussen

D € 2.275  
E € 2.455  
F € 2.635

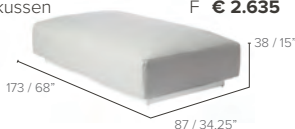

Corner Connector\*  
Connecteur d'angle\*  
Hoek Verbindingsstuk\* € 67

\*A connector is needed to create a corner sofa  
\*Un connecteur est nécessaire pour créer un canapé d'angle  
\*Een verbindingsstuk is nodig om een hoek-sofa te vormen



Custom covers = 165€ per single seat and 330€ for meridiene and daybed modules  
 Housses sur mesure = 165€ par siège simple et 330€ pour les modules méridienne et daybed  
 Covers op maat = 165€ per enkele zitplaats en 330€ voor meridiene en daybed modules

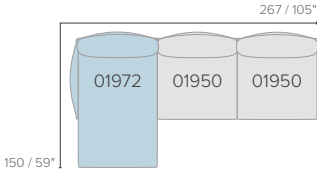
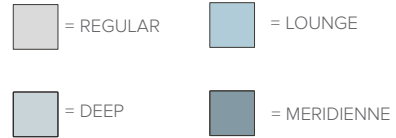

**SET 1**  
 Frame: 01972 + 2x 01950  
 Cushions: 3x C01902B + C01904S + 2x C01902S

Total price: Cat. D **€ 12.120** E **€ 12.675** F **€ 13.180**  
 Total price with corner cushion Cat. D **€ 12.670** E **€ 13.275** F **€ 13.830**  
 Cover: D1921 **€ 655** Cover with corner cushion: D2000 **€ 655**

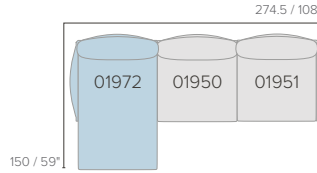

**SET 2**  
 Frame: 01972 + 01950 + 01951  
 Cushions: 3x C01902B + C01904S + 2x C01902S

Total price: Cat. D **€ 12.750** E **€ 13.305** F **€ 13.810**  
 Total price with corner cushions at sofa ends Cat. D **€ 13.850** E **€ 14.505** F **€ 15.110**  
 Cover: D1922 **€ 655** Cover with corner cushions at sofa ends: D1922C **€ 655**

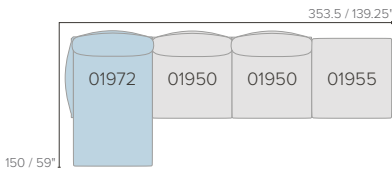

**SET 3**  
 Frame: 01972 + 2x 01950 + 01955  
 Cushions: 3x C01902B + C01904S + 3x C01902S

Total price: Cat. D **€ 14.465** E **€ 15.120** F **€ 15.720**  
 Total price with corner cushion Cat. D **€ 15.015** E **€ 15.720** F **€ 16.370**  
 Cover: D1923 **€ 820** Cover with corner cushion: D1923C **€ 820**

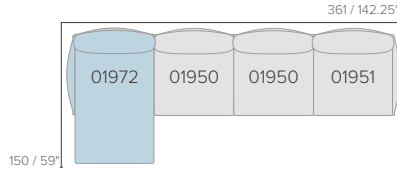

**SET 4**  
 Frame: 01972 + 2x 01950 + 01951  
 Cushions: 4x C01902B + C01904S + 3x C01902S

Total price: Cat. D **€ 16.205** E **€ 16.930** F **€ 17.585**  
 Total price with corner cushions at sofa ends Cat. D **€ 17.305** E **€ 18.130** F **€ 18.885**  
 Cover: D1924 **€ 820** Cover with corner cushions at sofa ends: D1924C **€ 820**

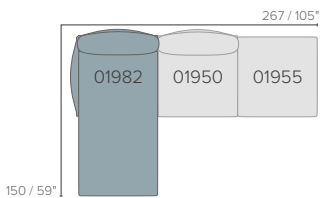

**SET 5**  
 Frame: 01982 + 01950 + 01955 + A1905  
 Cushions: 2x C01902B + C01905S + 2x C01902S

Total price: Cat. D **€ 11.857** E **€ 12.377** F **€ 12.857**  
 Total price with corner cushion Cat. D **€ 12.407** E **€ 12.977** F **€ 13.507**  
 Cover: D1925 **€ 655** Cover with corner cushion: D1925C **€ 655**

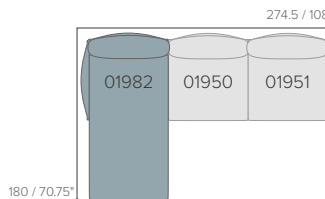

**SET 6**  
 Frame: 01982 + 01950 + 01951 + A1905  
 Cushions: 3x C01902B + C01905S + 2x C01902S

Total price: Cat. D **€ 13.597** E **€ 14.187** F **€ 14.722**  
 Total price with corner cushions at sofa ends Cat. D **€ 14.697** E **€ 15.387** F **€ 16.022**  
 Cover: D1926 **€ 655** Cover with corner cushions at sofa ends: D1926C **€ 655**

Combination examples  
Exemples de combinaisons  
Combinatievoorbeelden

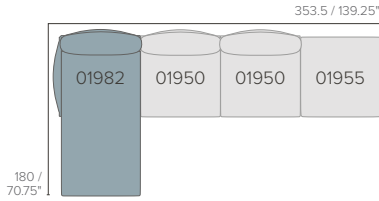

**SET 7**  
Frame: 01982 + 2x 01950 + 01955 + A1905  
Cushions: 3x C01902B + C01905S + 3x C01902S

Total price: Cat. D **€ 15.312** E **€ 16.002** F **€ 16.632**  
Total price with corner cushion Cat. D **€ 15.862** E **€ 16.602** F **€ 17.282**  
Cover: D1927 **€ 820** Cover with corner cushion: D1927C **€ 820**

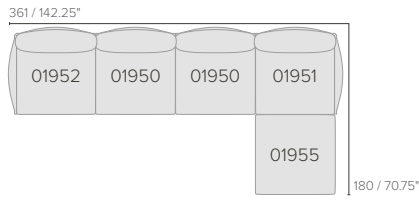

**SET 8**  
Frame: 01952 + 2x 01950 + 01951 + 01955 + A1905  
Cushions: 4x C01902B + 5x C01902S

Total price: Cat. D **€ 17.492** E **€ 18.272** F **€ 18.967**  
Total price with corner cushions at sofa ends Cat. D **€ 18.592** E **€ 19.472** F **€ 20.267**  
Cover: D1928 **€ 820** Cover with corner cushions at sofa ends: D1928C **€ 820**

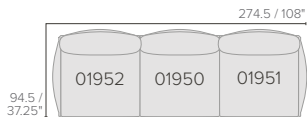

**SET 9**  
Frame: 01952 + 01950 + 01951  
Cushions: 3x C01902B + 3x C01902S

Total price: Cat. D **€ 11.625** E **€ 12.135** F **€ 12.585**  
Total price with corner cushions at sofa ends Cat. D **€ 12.725** E **€ 13.335** F **€ 13.885**  
Cover: D1929 **€ 490** Cover with corner cushions at sofa ends: D2003 **€ 490**

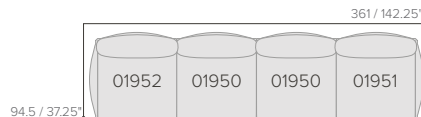

**SET 10**  
Frame: 01952 + 2x 01950 + 1x 01951  
Cushions: 4x C01902B + 4x C01902S

Total price: Cat. D **€ 15.080** E **€ 15.760** F **€ 16.360**  
Total price with corner cushions at sofa ends Cat. D **€ 16.180** E **€ 16.960** F **€ 17.660**  
Cover: D1930 **€ 655** Cover with corner cushions at sofa ends: D2025 **€ 655**

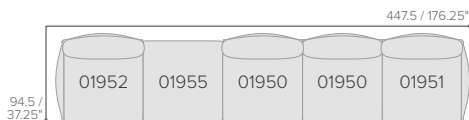

**SET 11**  
Frame: 01952 + 01955 + 2x 01950 + 1x 01951  
Cushions: 4x C01902B + 5x C01902S

Total price: Cat. D **€ 17.425** E **€ 18.205** F **€ 18.900**  
Total price with corner cushions at sofa ends Cat. D **€ 18.525** E **€ 19.405** F **€ 20.200**  
Cover: D1931 **€ 820** Cover with corner cushions at sofa ends: D1931C **€ 820**

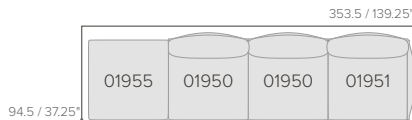

**SET 12**  
Frame: 01955 + 2x 01950 + 01951  
Cushions: 3x C01902B + 4x C01902S

Total price: Cat. D **€ 13.340** E **€ 13.950** F **€ 14.495**  
Total price with corner cushion Cat. D **€ 13.890** E **€ 14.550** F **€ 15.145**  
Cover: D1932 **€ 655** Cover with corner cushions: D1932C **€ 655**



Combination examples  
Exemples de combinaisons  
Combinatievoorbeelden

 = REGULAR  = LOUNGE

 = DEEP  = MERIDIENNE

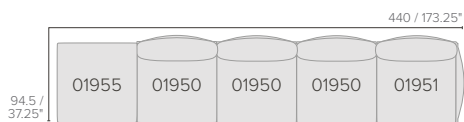

## SET 13

Frame: 01955 + 3x 01950 + 01951  
Cushions: 4x C01902B + 5x C01902S

Total price: Cat. D **€ 16.795** E **€ 17.575** F **€ 18.270**  
Total price with corner cushion Cat. D **€ 17.345** E **€ 18.175** F **€ 18.920**  
Cover: D1933 **€ 820** Corner cushion at sofa end: D1933C **€ 820**

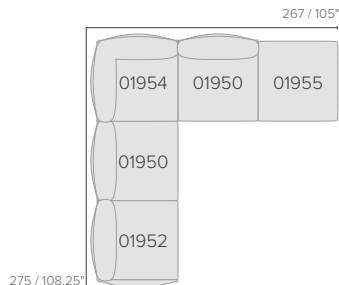

## SET 14

Frame: 01952 + 2x 01950 + 01954 + 01955 + A1905  
Cushions: C01901B + 3x C01902B + 5x C01902S

Total price: Cat. D **€ 18.042** E **€ 18.872** F **€ 19.617**  
Total price with extra corner cushion Cat. D **€ 18.592** E **€ 19.472** F **€ 20.267**  
Cover: D1934 **€ 820** Cover with corner cushion at sofa end: D1934C **€ 820**

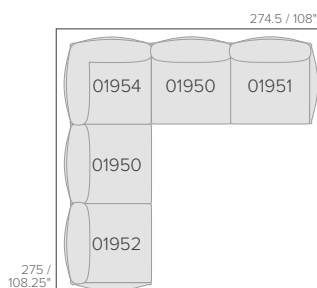

## SET 15

Frame: 01952 + 2x 01950 + 01954 + 01951 + A1905  
Cushions: C01901B + 4x C01902B + 5x C01902S

Total price: Cat. D **€ 19.782** E **€ 20.682** F **€ 21.482**  
Total price with corner cushions at sofa ends Cat. D **€ 20.882** E **€ 21.882** F **€ 22.782**  
Cover: D1935 **€ 820** Cover with corner cushions at sofa ends: D1935C **€ 820**

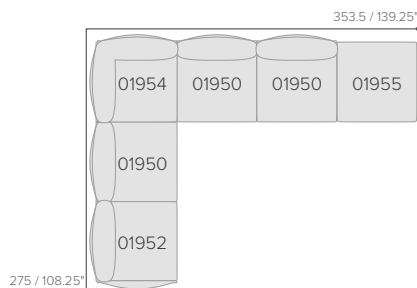

## SET 16

Frame: 01952 + 3x 01950 + 01954 + 01955 + A1905  
Cushions: C01901B + 4x C01902B + 6x C01902S

Total price: Cat. D **€ 21.497** E **€ 22.497** F **€ 23.392**  
Total price with extra corner cushion Cat. D **€ 22.047** E **€ 23.097** F **€ 24.042**  
Cover: D1936 **€ 980** Cover with corner cushion at sofa end: D1936C **€ 980**

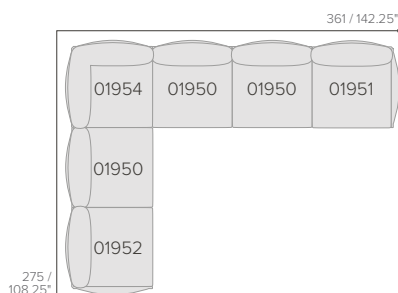

## SET 17

Frame: 01952 + 3x 01950 + 01954 + 01951 + A1905  
Cushions: C01901B + 5x C01902B + 6x C01902S

Total price: Cat. D **€ 23.237** E **€ 24.307** F **€ 25.257**  
Total price with corner cushions at sofa ends Cat. D **€ 24.337** E **€ 25.507** F **€ 26.557**  
Cover: D1937 **€ 980** Cover with corner cushions at sofa ends: D1937C **€ 980**

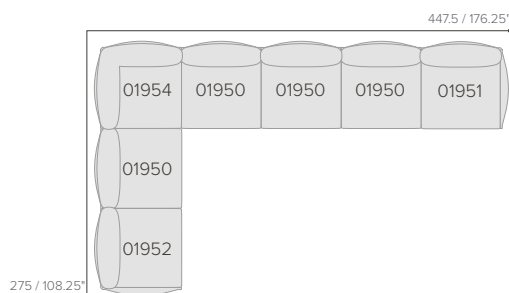

## SET 18

Frame: 01952 + 4x 01950 + 01954 + 01951 + A1905  
Cushions: C01901B + 6x C01902B + 7x C01902S

Total price: Cat. D **€ 26.692** E **€ 27.932** F **€ 29.032**  
Total price with corner cushions at sofa ends Cat. D **€ 27.792** E **€ 29.132** F **€ 30.332**  
Cover: D1938 **€ 1.145** Cover with corner cushion at sofa ends: D1938C **€ 1.145**

Combination examples  
Exemples de combinaisons  
Combinatievoorbeelden

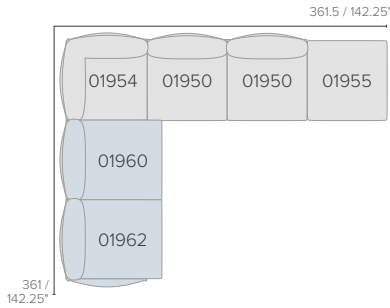
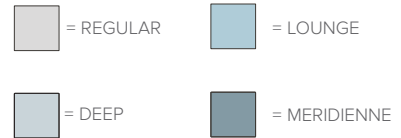

**SET 19**  
Frame: 01962 + 01960 + 01954 + 2x 01950 + 01955 + A1905  
Cushions: 2x C01903S + 4x C01902B + C01901B + 4x C01902S

Total price: Cat. D **€ 22.892** E **€ 23.932** F **€ 24.857**  
Total price with extra corner cushion Cat. D **€ 23.442** E **€ 24.532** F **€ 25.507**  
Cover: D1939 **€ 980** Cover with corner cushion at sofa end: D1939C **€ 980**

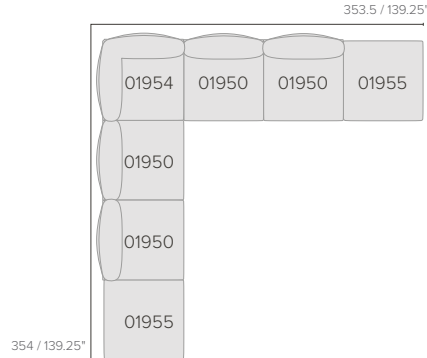

**SET 20**  
Frame: 2x 01955 + 4x 01950 + 01954 + A1905  
Cushions: C01901B + 4x C01902B + 7x C01902S

Total price: Cat. D **€ 23.212** E **€ 24.312** F **€ 25.302**  
Cover: D1941 **€ 1.145**

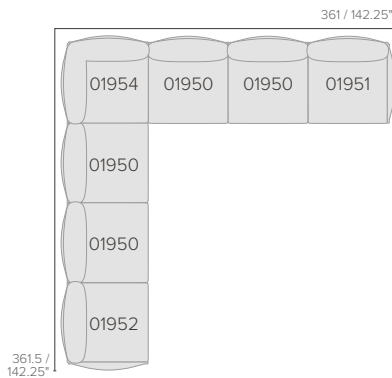

**SET 21**  
Frame: 01952 + 4x 01950 + 01954 + 01951 + A1905  
Cushions: C01901B + 6x C01902B + 7x C01902S

Total price: Cat. D **€ 26.692** E **€ 27.932** F **€ 29.032**  
Total price with corner cushions at sofa ends Cat. D **€ 27.792** E **€ 29.132** F **€ 30.332**  
Cover: D1942 **€ 1.145** Cover with corner cushions at sofa ends: D1942C **€ 1.145**

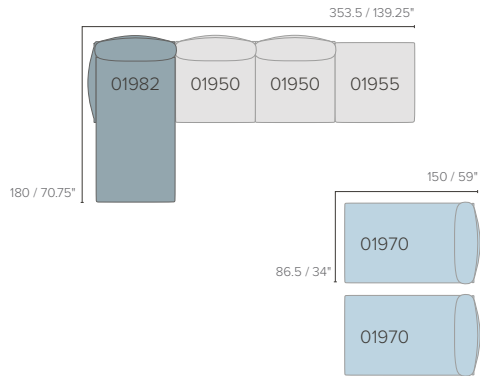

**SET 22**  
Frame: 01982 + 2x 01950 + 01955 + 2x 01970 + A1905  
Cushions: 5x C01902B + C01905S + 3x C01902S + 2x C01904S

Total price: Cat. D **€ 24.852** E **€ 25.972** F **€ 27.012**  
Total price with corner cushion Cat. D **€ 25.402** E **€ 26.572** F **€ 27.662**  
Cover: D1927 + 2x D1970 = **€ 820 + 2x € 300 = 1.300 €**  
Cover with corner cushion: D1927C + 2x D1970 = **€ 820 + 2x € 300 = 1.300 €**

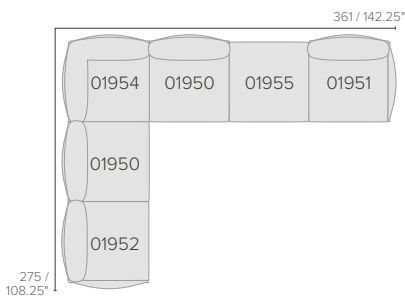

**SET 24**  
Frame: 01952 + 2x 01950 + 01954 + 01955 + 01951 + A1905  
Cushions: C01901B + 4x C01902B + 6x C01902S

Total price: Cat. D **€ 22.127** E **€ 23.127** F **€ 24.022**  
Total price with corner cushions at sofa ends Cat. D **€ 23.227** E **€ 24.327** F **€ 25.322**  
Cover: D1944 **€ 980** Cover with corner cushions at sofa ends: D1944C **€ 980**

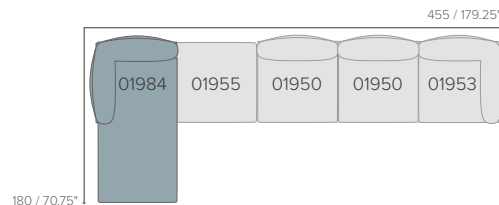

**SET 25**  
Frame: 01984 + 01955 + 2x 01950 + 01953 + A1905  
Cushions: C01905S + 4x C01902S + 2x C01901B + 2x C01902B

Total price: Cat. D **€ 20.497** E **€ 21.457** F **€ 22.337**  
Cover without corner cushions at sofa ends: D1945 **€ 980** Cover: D1945C **€ 980**





Plantation teak from Java  
Teck de plantation de Java  
Plantageteak uit Java

Armchair  
Fauteuil repas  
Armstoel

05018

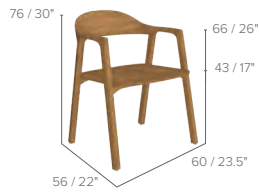

€ 1.685

**D5024**

Cover  
Housse  
Hoes  
€ 200

**C05018W**

Seat & back cushion D € 715  
Coussin d'assise et de dossier E € 820  
Zit-en rugkussen F € 935

**C05018SW**

Seat cushion D € 255  
Coussin d'assise E € 345  
Zitkussen F € 490



Lounge chair  
Fauteuil  
Lage stoel

05012



€ 2.275

**D5012**

Cover  
Housse  
Hoes  
€ 240

**C05012W**

Seat & back cushion D € 1.385  
Coussin d'assise et de dossier E € 1.455  
Zit-en rugkussen F € 1.645

**C05012SW**

Seat cushion D € 435  
Coussin d'assise E € 590  
Zitkussen F € 750



Powdercoated stainless steel  
Inox laqué par poudrage  
Gepoedercoat inox

Table top: glazed lava stone or ceramic  
Dessus de table: pierre de lave émaillée ou céramique  
Tafelblad: geglazuurde lavasteen of keramiek

\*This colour may possibly show veins  
\*Des veines peuvent éventuellement figurer sur cette couleur  
\*Deze kleur kan mogelijk anders vertonen

Dining table 264 cm  
Table à manger 264 cm  
Eettafel 264 cm



x-Table top: glazed Lava stone or Ceramic  
x-Dessus de table: pierre de lave émaillée ou céramique  
x-Tafelblad: geglazuurde lavasteen of keramiek

€ 14.685  
€ 11.400

02252-00-Lx  
02252-00-Cx

02252-10-Lx  
02252-10-Cx

02252-89-Lx  
02252-89-Cx

Dining table 352 cm  
Table à manger 352 cm  
Eettafel 352 cm

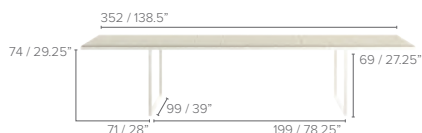

€ 18.130  
€ 13.680

02254-00-Lx  
02254-00-Cx

02254-10-Lx  
02254-10-Cx

02254-89-Lx  
02254-89-Cx



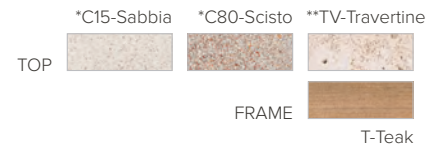

Plantation teak from Java  
Teck de plantation de Java  
Plantageteak uit Java

\*\* This material is sensitive to stains  
\*\* Ce matériau est sensible aux taches  
\*\* Dit materiaal is vlekgevoelig

\*This colour may possibly show veins.  
\*Des veines peuvent éventuellement figurer sur cette couleur  
\*Deze kleur kan mogelijk anders vertonen.

**Dining Table - Dia 148cm**



€ 6.100 Ceramic  
€ 11.000 Travertine

04266-Cx

04266-TV

**NEW / Low Dining Table - Dia 148cm**



€ 6.000 Ceramic  
€ 10.900 Travertine

04267-Cx

04267-TV

**Dining Table - 320x110cm**

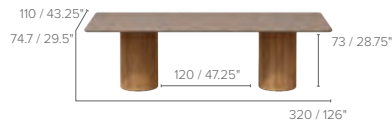

€ 9.990 Ceramic

04254-Cx

**Dining Table - 290x110cm**



€ 13.905 Travertine

04253-TV

Note: the height and clearance under the table may differ according to the type of table top. Please consult the product sheet on our website.

Remarque: la hauteur et le dégagement sous la table peuvent différer selon le type de dessus de table. Pour plus de détails, consultez la fiche produit sur notre site internet.

Opmerking: afhankelijk van het type tafelblad kunnen de hoogte en de vrije ruimte onder de tafel verschillen. Details vindt u op de productfiche op onze website.

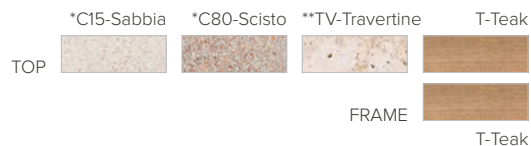

Plantation teak from Java  
Teck de plantation de Java  
Plantageteak uit Java

\*\* This material is sensitive to stains  
\*\* Ce matériau est sensible aux taches  
\*\* Dit materiaal is vlekgevoelig

\*This colour may possibly show veins.  
\*Des veines peuvent éventuellement figurer sur cette couleur  
\*Deze kleur kan mogelijk anders vertonen.

Side Table - H32cm



€ 1.495 Ceramic  
€ 1.495 Teak  
€ 2.100 Travertine

04281-Cx  
04281-T  
04281-TV

€ 1.695 Ceramic  
€ 1.695 Teak  
€ 2.600 Travertine

04283-Cx  
04283-T  
04283-TV

€ 2.145 Ceramic  
€ 2.145 Teak  
€ 4.600 Travertine

04284-Cx  
04284-T  
04284-TV

Side Table - H45cm

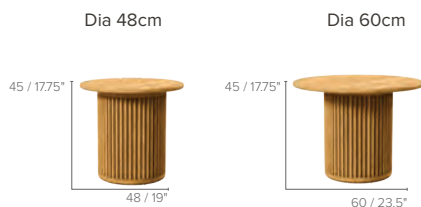

€ 1.595 Ceramic  
€ 1.595 Teak  
€ 2.200 Travertine

04280-Cx  
04280-T  
04280-TV

€ 1.795 Ceramic  
€ 1.795 Teak  
€ 2.600 Travertine

04282-Cx  
04282-T  
04282-TV



Powdercoated aluminium  
Aluminium laqué par poudrage  
Gepoedercoat aluminium

Plantation teak from Java  
Teck de plantation de Java  
Plantageteak uit Java

Sunscape  
Sunscape  
Sunscape

Base  
Base  
Basis

€ 5.915

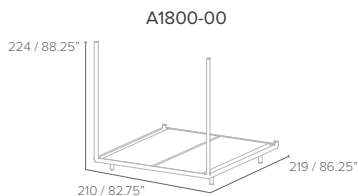

A1800-89

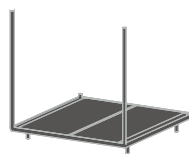

**D1800C**  
Cover\*  
House\*  
Hoes\*  
€ 385

**C01800SETW**  
Cushion set  
Set Coussin  
Kussen set

D € 2.440  
E € 2.640  
F € 2.845

\*Cover: covers the cushions only and is included in the article ref. and the price of the frame structure.

\*Housse: couvre seulement les coussins et est inclus dans le code article et le prix du cadre.

\*Hoes: bedekt enkel de kussens en is inbegrepen in de artikelcode en de prijs van het frame

Rear wall - Aluminium  
Paroi arrière - Aluminium  
Achterwand - Aluminium

€ 3.055

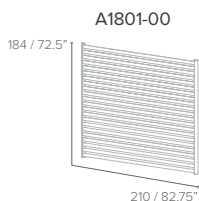

A1801-89

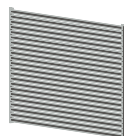

Rear wall - Sunscape  
Paroi arrière - Sunscape  
Achterwand - Sunscape

€ 2.420



A1802-89-S64



Sunscape:



S54-Oyster S64-Nature Grey



S70-stone

Rear wall - Teak  
Paroi arrière - Teak  
Achterwand - Teak

€ 3.695

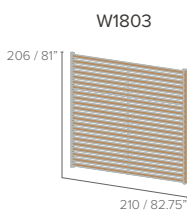

T-Teak

Rear wall - Empty  
Paroi arrière - Vide  
Achterwand - Leeg

€ 1.140

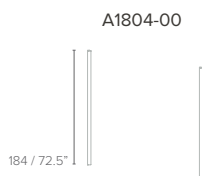

A1804-89



# PAVILION DAYBED

MONICA ARMANI



Powdercoated aluminium  
Aluminium laqué par poudrage  
Gepoedercoat aluminium

Plantation teak from Java  
Teck de plantation de Java  
Plantageteak uit Java

Sunscape  
Sunscape  
Sunscape

Curtains in Sunbrella Velum  
Rideaux en Sunbrella Velum  
Gordijnen in Sunbrella Velum

Roof - Aluminium  
Toit - Aluminium  
Dak - Aluminium

€ 4.435

A1805-00

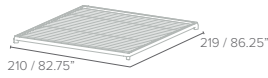

A1805-89

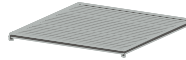

Roof - movable Sunscape  
Toit - Sunscape amovible  
Dak - wegschuifbare Sunscape

€ 3.800

A1807-00-S54  
A1807-00-S70

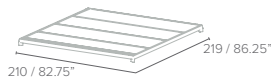

A1807-89-S64

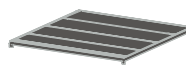

Sunscape:

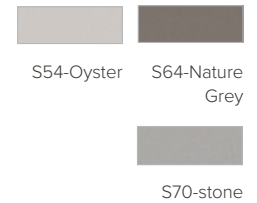

Roof - Teak  
Toit - Teck  
Dak - Teak

€ 5.075

W1808

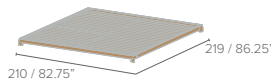

T-Teak

Curtain  
Rideau  
Gordijn

€ 1.265 Set of 2

P1809-V54



P1809-V64



P1809-V70



Velum:

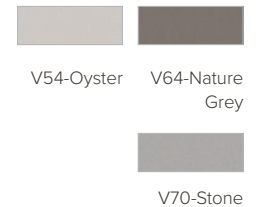



x: colour base  
x: couleur base  
x: kleur basis

y: colour wall  
y: couleur paroi arrière  
y: kleur achterwand

z: colour roof  
z: couleur toit  
z: kleur dak

Cushions, curtains and side table should be ordered separately  
Coussins, rideaux et table d'appoint à commander séparément  
Kussens, gordijnen en bijzettafel moeten apart besteld worden

Rear wall aluminium

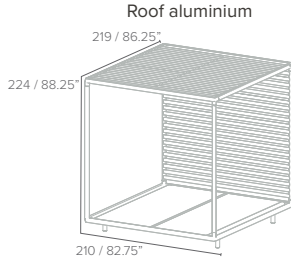

**Roof aluminium**  
01811-x-y-z  
Total price: € 13.405  
Total price with cushions:  
D € 15.845  
E € 16.045  
F € 16.250  
Cover included

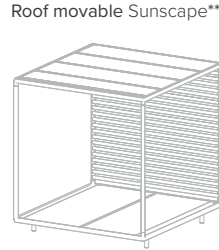

**Roof movable Sunscape\*\***  
01813-x-y-z  
Total price: € 12.770  
Total price with cushions:  
D € 15.210  
E € 15.410  
F € 15.615  
Cover included

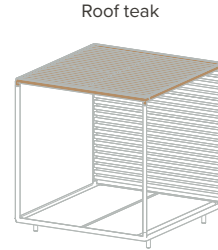

**Roof teak**  
01814-x-y-T  
Total price: € 14.045  
Total price with cushions:  
D € 16.485  
E € 16.685  
F € 16.890  
Cover included

Rear wall Sunscape\*\*

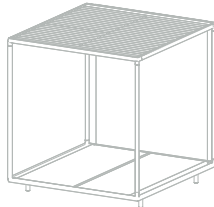

01821-x-y-z  
Total price: € 12.770  
Total price with cushions:  
D € 15.210  
E € 15.410  
F € 15.615  
Cover included

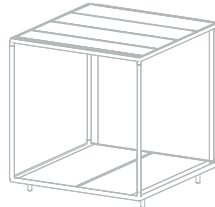

01823-x-y-z  
Total price: € 12.130  
Total price with cushions:  
D € 14.570  
E € 14.770  
F € 14.975  
Cover included

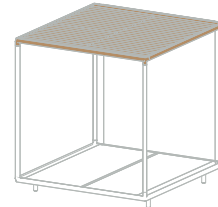

01824-x-y-T  
Total price: € 13.405  
Total price with cushions:  
D € 15.845  
E € 16.045  
F € 16.250  
Cover included

Rear wall teak

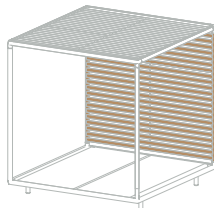

01831-x-T-z  
Total price: € 14.045  
Total price with cushions:  
D € 16.485  
E € 16.685  
F € 16.890  
Cover included

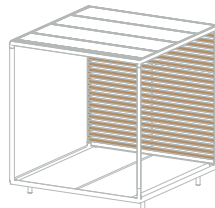

01833-x-T-z  
Total price: € 13.405  
Total price with cushions:  
D € 15.845  
E € 16.045  
F € 16.250  
Cover included

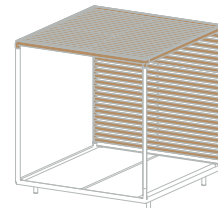

01834-x-T-T  
Total price: € 14.685  
Total price with cushions:  
D € 17.125  
E € 17.325  
F € 17.530  
Cover included

Rear wall empty

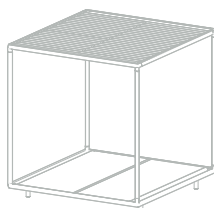

01841-x-y-z  
Total price: € 11.490  
Total price with cushions:  
D € 13.930  
E € 14.130  
F € 14.335  
Cover included

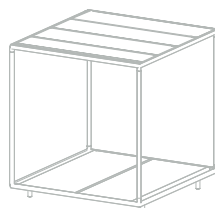

01843-x-y-z  
Total price: € 10.855  
Total price with cushions:  
D € 13.295  
E € 13.495  
F € 13.700  
Cover included

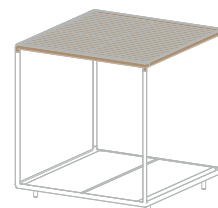

01844-x-y-T  
Total price: € 12.130  
Total price with cushions:  
D € 14.570  
E € 14.770  
F € 14.975  
Cover included

\*\* Possible colour combinations, see p. 62-63

\*\* Pour des combinaisons de couleurs possible, voir p. 62-63

\*\* Voor mogelijke kleurcombinaties, zie p. 62-63

Plantation teak from Java  
Teck de plantation de Java  
Plantageteak uit Java

Roof in Sunscape  
Toit en Sunscape  
Dak in Sunscape

Curtains in Sunbrella Velum  
Rideaux en Sunbrella Velum  
Gordijnen in Sunbrella Velum

Cushions and curtains should be ordered separately  
Coussins et rideaux à commander séparément  
Kussens en gordijnen moeten apart besteld worden

 Cabana daybed  
Lit de jour Cabana  
Cabana daybed

01249-S54

01249-S64

01249-S70

€ 12.750



**D1249C**

Cover\*  
Housse\*  
Hoes\*  
€ 385

**C01249SETW**

Cushion Set  
Coussin Set  
Kussen Set

D € 3.735

E € 4.285

F € 4.935

\*Cover: covers the cushions only and is included in the article ref. and the price of the daybed.

\*Housse: couvre seulement les coussins et est inclus dans le code article et le prix du lit de jour.

\*Hoes: bedekt enkel de kussens en is inbegrepen in de artikelcode en de prijs van het daybed

Curtain  
Rideau  
Gordijn

P1209-V54

P1209-V64

P1209-V70



Velum:

V54-Oyster  V64-Nature Grey  V70-Stone

€ 1.265 Set of 2





Plantation teak from Java  
Teck de plantation de Java  
Plantageteak uit Java

C-table  
Table-C  
C-tafel

€ 900

Teak



D6123  
Cover  
Housse  
Hoes  
€ 125



Lounger  
Chaise longue  
Ligbed



€ 2.040

D1242  
Cover  
Housse  
Hoes  
€ 285

C01242W  
Cushion  
Coussin  
Kussen

D € 1.865  
E € 2.140  
F € 2.470



Lounger  
Chaise longue  
Ligbed



€ 2.295

01243 - with wheels\*

€ 2.250

01244 - with legs

D1242  
Cover  
Housse  
Hoes  
€ 285

C01242W  
Cushion  
Coussin  
Kussen

D € 1.865  
E € 2.140  
F € 2.470



C01242W  
Cushion  
Coussin  
Kussen

D € 1.865  
E € 2.140  
F € 2.470



\* The lounger is equipped with wheels positioned on the inside, allowing easy mobility.

\* La chaise longue est équipée de roues placées à l'intérieur, ce qui permet de la déplacer facilement.





\* Het ligbed heeft wieljes aan de binnenkant, waardoor het gemakkelijk te verplaatsen is.

# PURE SOFA

ANDREI MUNTEANU

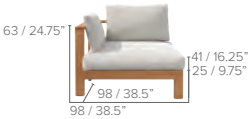
Plantation teak from Java  
Teck de plantation de Java  
Plantageteak uit Java

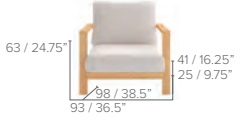
Extra soft filling (Seat + back + armrests cushions)  
Rembourrage particulièrement doux (Coussin d'assise + dossier + bras)  
Extra zachte vulling (Zit + rugkussens + armsteun)

	 <p>63 / 24.75" 41 / 16.25" 25 / 9.75" 98 / 38.5"</p>	 <p>41 / 16.25"</p>	 <p>63 / 24.75" 41 / 16.25" 25 / 9.75" 98 / 38.5" 93 / 36.5"</p>	<p>Extra back cushion Coussin supplémentaire Extra rugkussen 75.5x48x5cm</p>
Frame	01201 € 1.725	01201 € 1.725	01202s € 1.740	<b>C01201BCAW</b> D € 370 E € 390 F € 425
Cushion	C01201CAW D € 1.825 E € 2.030 F € 2.230	C01211CAW D € 1.875 E € 2.140 F € 2.450	C01202sCAW D € 1.430 E € 1.620 F € 1.795	
Cover	D6008C € 260	D1211 € 260	D6050C € 305	

	 <p>193 / 76" 98 / 38.5" 25 / 9.75"</p>		 <p>63 / 24.75" 41 / 16.25" 25 / 9.75" 185 / 72.75" 98 / 38.5"</p>	<p>Corner Back Only <b>C01204BCAW</b> D € 825 E € 955 F € 1.110</p> 
Frame	01204 € 2.540	01204 € 2.540	01228 € 2.340	
Cushion	C01205CAW D € 3.510 E € 3.930 F € 4.360	C01215CAW D € 3.560 E € 4.040 F € 4.580	C01228CAW D € 3.130 E € 3.510 F € 3.925	Right/Left Arm Back Only <b>C01212BCAW</b>
Cover	D6007RC € 385	D1215R € 385	D1228 € 380	D € 405 E € 455 F € 505

	 <p>63 / 24.75" 41 / 16.25" 25 / 9.75" 193 / 76" 98 / 38.5"</p>	
Frame	01203 € 2.540	01203 € 2.540
Cushion	C01205CAW D € 3.510 E € 3.930 F € 4.360	C01215CAW D € 3.560 E € 4.040 F € 4.580
Cover	D6007LC € 385	D1215L € 385

	 <p>63 / 24.75" 41 / 16.25" 25 / 9.75" 200 / 78.75" 98 / 38.5"</p>		<p>2-Seater Back Only <b>C01213BCAW</b> D € 450 E € 505 F € 560</p> 	<p>Corner Back - Left Arm Only <b>C01208BCAW</b> D € 880 E € 1.020 F € 1.195</p>
Frame	01207 € 2.695	01207 € 2.695		Corner Back - Right Arm Only <b>C01209BCAW</b>
Cushion	C01206CAW D € 3.445 E € 3.895 F € 4.305	C01216CAW D € 3.545 E € 4.115 F € 4.745		D € 880 E € 1.020 F € 1.195
Cover	D6049C € 440	D1216 € 440		

## OPTIONAL

Set of 2 connectors  
Set de 2 connecteurs  
Set van 2 verbindingsstukken

R0022

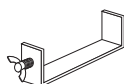

€ 34

**C01200CAW**  
Optional lumbar/Armrest cushion D € 270  
Coussin lombaire optionnel E € 320  
Optioneel lendekussen F € 360





Combination examples  
Exemples de combinaisons  
Combinatievoorbeelden

Custom covers = 165€, per single seat and 330€ for meridienne and daybed modules  
Housses sur mesure = 165€ par siège simple et 330€ pour les modules méridienne et daybed  
Covers op maat = 165€ per enkele zitplaats en 330€ voor meridienne en daybed modules

 = CORNER CUSHION

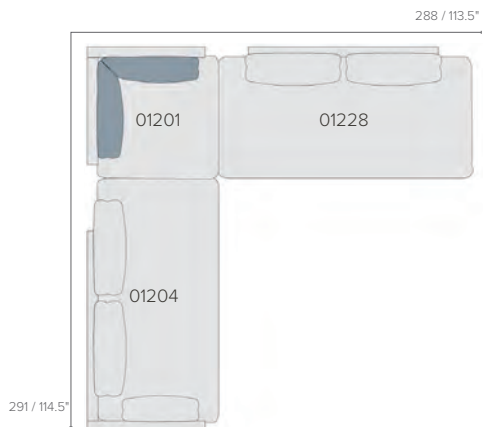

SET 1  
frame: 1x 01204 - 1x 01201 - 1x 01228  
cushions: C01205CAW + C01211CAW + C01228CAW  
connectors: 2x

total price with cushions: Cat. D € 15.188 E € 16.253 F € 17.408  
cover: D1301C € 825

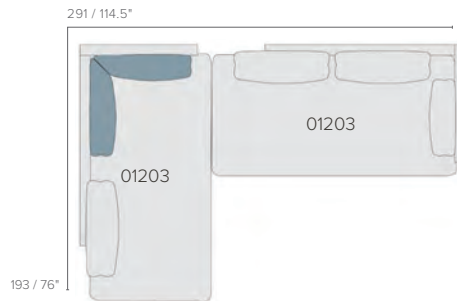

SET 2  
frame: 2x 01203  
cushions: C01215CAW + C01205CAW  
connectors: 1x

total price with cushions: Cat. D € 12.184 E € 13.084 F € 14.054  
cover: D1302C € 660

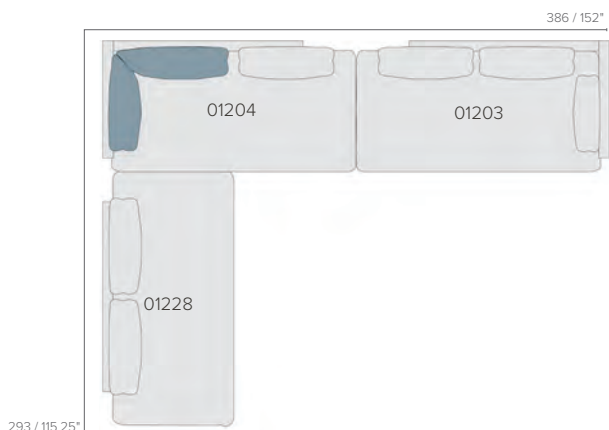

SET 3  
frame: 1x 01228 - 1x 01204 - 1x 01203  
cushions: C01228CAW + C01215CAW + C01205CAW  
connectors: 2x

total price with cushions: Cat. D € 17.688 E € 18.968 F € 20.353  
cover: D1303C € 990

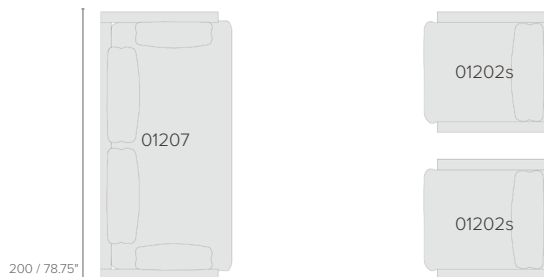

SET 4  
frame: 1x 01207 - 2x 01202s  
cushions: C01206CAW + 2x C01202sCAW

total price with cushions: Cat. D € 12.480 E € 13.310 F € 14.070  
covers: 1x D6049C + 2x D6050C = € 440 + 2x € 305 = 1.050 €



SET 5  
frame: 1x 01204 - 1x 01201 - 1x 01228 - 1x 01203  
cushions: 2x C01205CAW + C01211CAW + C01228CAW  
connectors: 3x

total price with cushions: Cat. D € 21.272 E € 22.757 F € 24.342  
covers: D1305C € 1.155

# PURE SETS

Custom covers = 165€ per single seat and 330€ for meridienne and daybed modules  
 Housses sur mesure = 165€ par siège simple et 330€ pour les modules méridienne et daybed  
 Covers op maat = 165€ per enkele zitplaats en 330€ voor meridienne en daybed modules

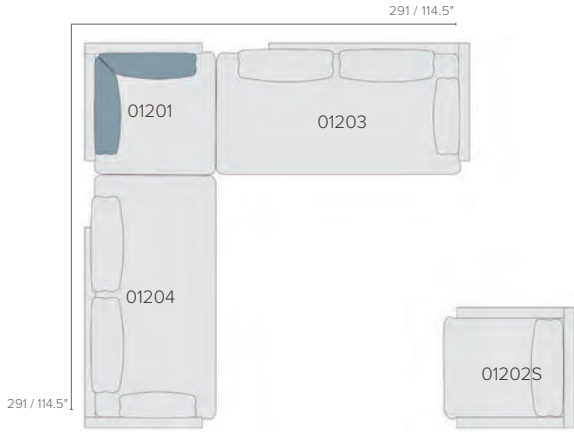

## SET 8

frame: 1x 01204 - 1x 01203 - 1x 01201 - 1x 01202s  
 cushions: 2x C01205CAW + C01211CAW + C01202sCAW  
 connectors: 2x

total price with cushions: Cat. D **€ 18.938 E € 20.233 F € 21.578**  
 covers: 1x D1308C + 1x D6050C = **€ 825 + € 305 = € 1.130**

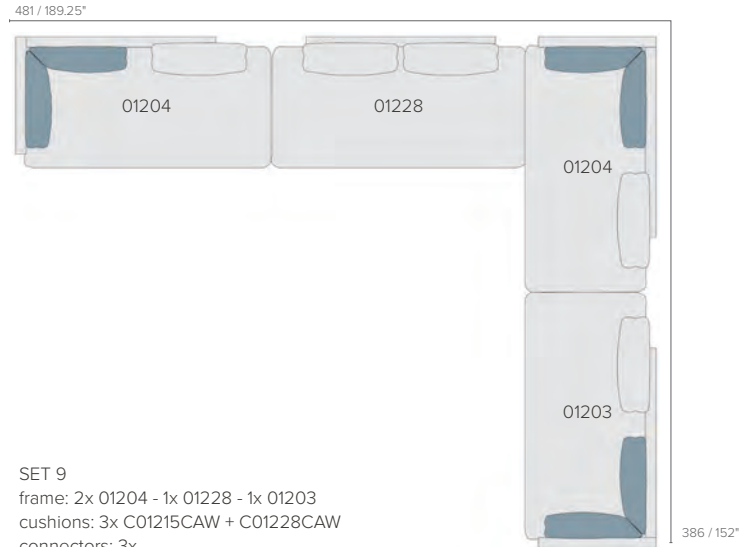

## SET 9

frame: 2x 01204 - 1x 01228 - 1x 01203  
 cushions: 3x C01215CAW + C01228CAW  
 connectors: 3x

total price with cushions: Cat. D **€ 23.872 E € 25.692 F € 27.727**  
 cover: D1309C **€ 1.320**

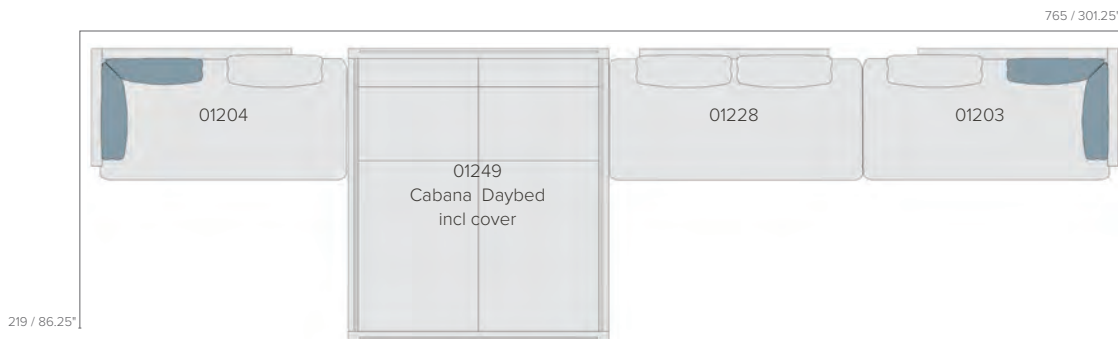

## SET 10

frame: 01204 - 01249 - 01228 - 01203  
 cushions: 2x C01215CAW + C01249SETW + C01228CAW  
 connectors: 3x

total price with cushions: Cat. D **€ 34.257 E € 36.147 F € 38.292**  
 cover: 1x D1215R + D1310C = **€ 385 + € 660 = € 1.045**

## SET 12

frame: 2x 01204 - 1x 01244  
 cushions: 2x C01215CAW + C01242W  
 connectors: 2x

total price with cushions: Cat. D **€ 16.383 E € 17.618 F € 19.028**  
 cover: D1312C **€ 945**





CANAX  
10-Linen

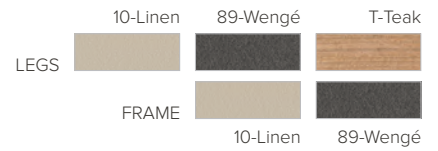

Powdercoated aluminium  
Aluminium peint par poudrage  
Gepoedercoat aluminium

Legs: powdercoated aluminium or teak (set of 4)  
Pieds: alu peint par poudrage ou teck (set de 4)  
Poten: gepoedercoat alu of teak (set van 4)

Canax®  
Canax®  
Canax®



Armchair  
Fauteuil repas  
Armstoel

€ 995



**D2318**  
Cover  
Housse  
Hoes  
€ 215

**C02318BW**  
Back cushion  
Coussin dossier  
Rugkussen  
D € 175  
E € 210  
F € 255

**C02318SW**  
Seat cushion  
Coussin d'assise  
Zitkussen  
D € 300  
E € 340  
F € 360



**C0001PW**  
Back cushion with piping  
Coussin dossier passepoil  
Rugkussen met bies  
D € 155  
E € 185  
F € 210

**C02318SW**  
Seat cushion  
Coussin d'assise  
Zitkussen  
D € 300  
E € 340  
F € 360



Piping colours see page 115  
Couleurs passepoil voir page 115  
Bieskleuren zie pagina 115



Lounge chair  
Fauteuil  
Lage Stoel

€ 1.295



**D2316**  
Cover  
Housse  
Hoes  
€ 215

**C02312BW**  
Back cushion  
Coussin dossier  
Rugkussen  
D € 290  
E € 320  
F € 365

**C02312SW**  
Seat cushion  
Coussin d'assise  
Zitkussen  
D € 340  
E € 370  
F € 400



Powdercoated aluminium  
Aluminium peint par poudrage  
Gepoedercoat aluminium

Seat: Batyline®  
Siège: Batyline®  
Zit: Batyline®

Adjustable lounger  
Chaise longue réglable  
Ligbed, verstelbaar

02340-10

02340-89

€ 2.190



**D2340**  
Cover  
Housse  
Hoes  
€ 240

**C02340W**  
Cushion  
Coussin  
Kussen

D € 1.510  
E € 1.695  
F € 1.900



Lounger with teak table top  
Chaise longue avec dessus de table teck  
Ligbed met teak tafelblad

02341-10

02341-89

€ 2.830



**D2341**  
Cover with table top  
Housse avec dessus  
de table  
Hoes met tafelblad  
€ 300

**C02340W**  
Cushion  
Coussin  
Kussen

D € 1.510  
E € 1.695  
F € 1.900





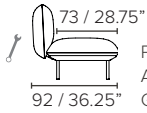
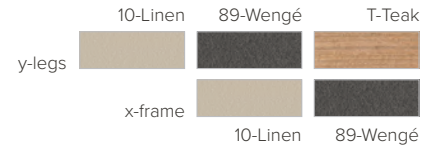





Powdercoated aluminium  
Aluminium peint par poudrage  
Gepoedercoat aluminium







Legs: powdercoated aluminium or teak (set of 4)  
Pieds: alu peint par poudrage ou teck (set de 4)  
Poten: gepoedercoat alu of teak (set van 4)







Casual back cushions (C02300W) recommended for optimal comfort  
Coussins de dos Casual (C02300W) recommandés pour un confort optimal  
Casual rugkussens (C02300W) aanbevolen voor optimaal comfort







	Pouf module	Single module	1-Seater sofa arm high	1-Seater sofa arm low	Coffee table teak	Coffee table Lava stone
Frame	 86 / 33.75" 023200-x-y € 845	 023201-x-y € 1.145	 122 / 48" 77 / 30.25" 023202-x-y € 1.735	 120 / 47.25" 62 / 24.5" 023203-x-y € 1.695	 86 / 33.75" 28 / 11" 023204-x-y-T € 1.780	 023205-x-y-Lx € 3.845
Cushion	C023200W D € 780 E € 885 F € 975	C023201W D € 1.520 E € 1.715 F € 1.900	C023202W D € 2.840 E € 3.195 F € 3.510	C023203W D € 2.660 E € 2.945 F € 3.210		
Cover	D23200 € 135	D23201 € 190	D23202 € 280	D23203 € 275	D23204 € 130	D23204 € 130

	Double pouf module	Pouf + teak table*	Single module + pouf*	Single module + teak table*	Double module
Frame	 168 / 66.25" 023801-x-y € 1.100	 023802-x-y-T € 2.035	 023803-x-y € 1.400	 023804-x-y-T € 2.335	 023805-x-y € 1.700
Cushion	C023801W D € 1.300 E € 1.505 F € 1.680	C023802W D € 780 E € 885 F € 975	C023803W D € 2.305 E € 2.605 F € 2.875	C023804W D € 1.520 E € 1.730 F € 1.900	C023805W D € 2.800 E € 3.195 F € 3.535
Cover	D23801 € 250	D23802 € 250	D23803 € 260	D23804 € 260	D23805 € 290

\*This module can also be mirrored  
\*Ce module peut également être mis en miroir  
\*Deze module kan ook gespiegeld worden

	Right corner arm high	Left corner arm high	Right corner arm low	Left corner arm low	2-Seater arm high	2-Seater arm low
Frame	 186 / 73.25" 023806-x-y € 1.995	 186 / 73.25" 023807-x-y € 1.995	 186 / 73.25" 023808-x-y € 1.975	 186 / 73.25" 023809-x-y € 1.975	 186 / 73.25" 023810-x-y € 2.290	 186 / 73.25" 023811-x-y € 2.250
Cushion	C023806W D € 3.460 E € 3.935 F € 4.340	C023807W D € 3.460 E € 3.935 F € 4.340	C023808W D € 3.370 E € 3.810 F € 4.190	C023809W D € 3.370 E € 3.810 F € 4.190	C023810W D € 4.120 E € 4.675 F € 5.145	C023811W D € 3.940 E € 4.425 F € 4.845
Cover	D23806 € 320	D23807 € 320	D23808 € 315	D23809 € 315	D23810 € 330	D23811 € 340

	2-Seater right arm low	2-Seater left arm low	Right corner arm high + pouf	Left corner arm high + pouf	Right corner arm low + pouf	Left corner arm low + pouf
Frame	 203 / 80" 023812-x-y € 2.270	 203 / 80" 023813-x-y € 2.270	 177 / 30.25" 023814-x-y € 1.695	 177 / 30.25" 023815-x-y € 1.695	 177 / 30.25" 023816-x-y € 1.675	 177 / 30.25" 023817-x-y € 1.675
Cushion	C023812W D € 4.030 E € 4.550 F € 4.995	C023813W D € 4.030 E € 4.550 F € 4.995	C023814W D € 2.965 E € 3.345 F € 3.680	C023815W D € 2.965 E € 3.345 F € 3.680	C023816W D € 2.875 E € 3.220 F € 3.620	C023817W D € 2.875 E € 3.220 F € 3.620
Cover	D23812 € 315	D23813 € 315	D23814 € 300	D23815 € 300	D23816 € 290	D23817 € 290

	Right corner arm high + teak table	Left corner arm high + teak table	Right corner arm low + teak table	Left corner arm low + teak table	Right corner back low + pouf	Left corner back low + pouf
Frame	 186 / 73.25" 28 / 11" 023818-x-y-T € 2.630	 186 / 73.25" 28 / 11" 023819-x-y-T € 2.630	 186 / 73.25" 28 / 11" 023820-x-y-T € 2.610	 186 / 73.25" 28 / 11" 023821-x-y-T € 2.610	 186 / 73.25" 28 / 11" 023822-x-y € 1.690	 186 / 73.25" 28 / 11" 023823-x-y € 1.690
Cushion	C023818W D € 2.180 E € 2.470 F € 2.705	C023819W D € 2.180 E € 2.470 F € 2.705	C023820W D € 2.090 E € 2.345 F € 2.555	C023821W D € 2.090 E € 2.345 F € 2.555	C023822W D € 2.525 E € 2.800 F € 3.050	C023823W D € 2.525 E € 2.800 F € 3.050
Cover	D23818 € 300	D23819 € 300	D23820 € 290	D23821 € 290	D23822 € 290	D23823 € 290

# SENJA SOFA REGULAR

STUDIO SEGERS

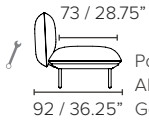
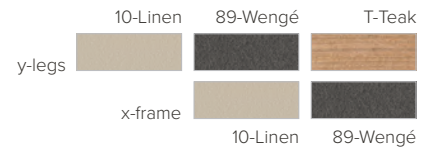

Powdercoated aluminium  
Aluminium peint par poudrage  
Gepoedercoat aluminium

Legs: powdercoated aluminium or teak (set of 4)  
Pieds: alu peint par poudrage ou teck (set de 4)  
Poten: gepoedercoat alu of teak (set van 4)

Casual back cushions (C02300W) recommended for optimal comfort  
Coussins de dos Casual (C02300W) recommandés pour un confort optimal  
Casual rugkussens (C02300W) aanbevolen voor optimaal comfort

Triple pouf module

Triple module

3-Seater arm high

3-Seater arm low

3-Seater right arm low

					
Frame	023901-x-y € 1.460	023902-x-y € 2.360	023903-x-y € 2.950	023904-x-y € 2.910	023905-x-y € 2.930
Cushion	C023901W D € 1.810 E € 2.100 F € 2.340	C023902W D € 4.065 E € 4.635 F € 5.125	C023903W D € 5.385 E € 6.115 F € 6.735	C023904W D € 5.205 E € 5.865 F € 6.435	C023905W D € 5.295 E € 5.990 F € 6.585
Cover	D23901 € 365	D23902 € 425	D23903 € 485	D23904 € 490	D23905 € 495





3-Seater left arm low

Right extension + pouf

Left extension + pouf

Right extension + teak table

Left extension + teak table

					
Frame	023906-x-y € 2.930	023907-x-y € 2.060	023908-x-y € 2.060	023909-x-y-T € 2.995	023910-x-y-T € 2.995
Cushion	C023906W D € 5.295 E € 5.990 F € 6.585	C023907W D € 3.310 E € 3.785 F € 4.205	C023908W D € 3.310 E € 3.785 F € 4.205	C023909W D € 2.800 E € 3.195 F € 3.535	C023910W D € 2.800 E € 3.195 F € 3.535
Cover	D23906 € 495	D23907 € 405	D23908 € 405	D23909 € 405	D23910 € 405

Right corner arm high

Left corner arm high

Right corner arm low

Left corner arm low

				
Frame	023911-x-y € 2.655	023912-x-y € 2.655	023913-x-y € 2.635	023914-x-y € 2.635
Cushion	C023911W D € 4.725 E € 5.375 F € 5.930	C023912W D € 4.725 E € 5.375 F € 5.930	C023913W D € 4.635 E € 5.250 F € 5.780	C023914W D € 4.635 E € 5.250 F € 5.780
Cover	D23911 € 470	D23912 € 470	D23913 € 465	D23914 € 465

Right corner arm high + pouf

Left corner arm high + pouf

Right corner arm low + pouf

Left corner arm low + pouf

				
Frame	023915-x-y € 2.355	023916-x-y € 2.355	023917-x-y € 2.335	023918-x-y € 2.335
Cushion	C023915W D € 3.970 E € 4.525 F € 5.010	C023916W D € 3.970 E € 4.525 F € 5.010	C023917W D € 3.880 E € 4.400 F € 4.860	C023918W D € 3.880 E € 4.400 F € 4.860
Cover	D23915 € 430	D23916 € 430	D23917 € 425	D23918 € 425

Right corner arm high + teak table

Left corner arm high + teak table

Right corner arm low + teak table

Left corner arm low + teak table

				
Frame	023919-x-y-T € 3.290	023920-x-y-T € 3.290	023921-x-y-T € 3.270	023922-x-y-T € 3.270
Cushion	C023919W D € 3.460 E € 3.935 F € 4.340	C023920W D € 3.460 E € 3.935 F € 4.340	C023921W D € 3.370 E € 3.810 F € 4.190	C023922W D € 3.370 E € 3.810 F € 4.190
Cover	D23919 € 430	D23920 € 430	D23921 € 425	D23922 € 425



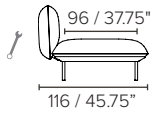
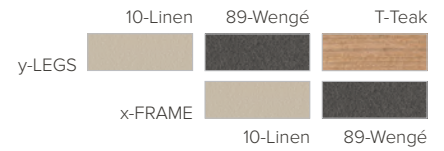

Powdercoated aluminium  
Aluminium peint par poudrage  
Gepoedercoat aluminium

Legs: powdercoated aluminium or teak (set of 4)  
Pieds: alu peint par poudrage ou teck (set de 4)  
Poten: gepoedercoat alu of teak (set van 4)

Casual back cushions (C02300W) recommended for optimal comfort  
Coussins de dos casual (C02300W) recommandés pour un confort optimal  
Casual rugkussens (C02300W) aanbevolen voor optimaal comfort

### Double pouf module

### Pouf + teak table\*

### Single module + pouf\*

### Single module + teak table\*

### Double module

Frame	023851-x-y € 1.220	023852-x-y-T € 2.415	023853-x-y € 1.520	023854-x-y-T € 2.715	023855-x-y € 1.820
Cushion	C023851W D € 1.605 E € 1.800 F € 1.980	C023852W D € 935 E € 1.035 F € 1.130	C023853W D € 2.355 E € 2.650 F € 2.905	C023854W D € 1.685 E € 1.880 F € 2.055	C023855W D € 3.105 E € 3.495 F € 3.835
Cover	D23851 € 290	D23852 € 290	D23853 € 305	D23854 € 305	D23855 € 330

\*This module can also be mirrored.  
\*Ce module peut également être mis en miroir.  
\*Deze module kan ook gespiegeld worden.

### Right corner arm high

### Left corner arm high

### Right corner arm low

### Left corner arm low

### 2-Seater arm high

### 2-Seater arm low

Frame	023856-x-y € 2.130	023857-x-y € 2.130	023858-x-y € 2.120	023859-x-y € 2.120	023860-x-y € 2.440	023861-x-y € 2.420
Cushion	C023856W D € 3.885 E € 4.385 F € 4.820	C023857W D € 3.885 E € 4.385 F € 4.820	C023858W D € 3.775 E € 4.225 F € 4.625	C023859W D € 3.775 E € 4.225 F € 4.625	C023860W D € 4.665 E € 5.275 F € 5.805	C023861W D € 4.445 E € 4.955 F € 5.415
Cover	D23856 € 370	D23857 € 370	D23858 € 365	D23859 € 365	D23860 € 380	D23861 € 385

### 2-Seater right arm low

### 2-Seater left arm low

### Right corner arm high + pouf

### Left corner arm high + pouf

### Right corner arm low + pouf

### Left corner arm low + pouf

Frame	023862-x-y € 2.430	023863-x-y € 2.430	023864-x-y € 1.830	023865-x-y € 1.830	023866-x-y € 1.820	023867-x-y € 1.820
Cushion	C023862W D € 4.555 E € 4.955 F € 5.415	C023863W D € 4.555 E € 4.955 F € 5.415	C023864W D € 3.135 E € 3.540 F € 3.890	C023865W D € 3.135 E € 3.540 F € 3.890	C023866W D € 3.025 E € 3.380 F € 3.695	C023867W D € 3.025 E € 3.380 F € 3.695
Cover	D23862 € 365	D23863 € 365	D23864 € 345	D23865 € 345	D23866 € 330	D23867 € 330

### Right corner arm high + teak table

### Left corner arm high + teak table

### Right corner arm low + teak table

### Left corner arm low + teak table

Frame	023868-x-y-T € 3.025	023869-x-y-T € 3.025	023870-x-y-T € 3.015	023871-x-y-T € 3.015
Cushion	C023868W D € 2.465 E € 2.770 F € 3.010	C023869W D € 2.465 E € 2.770 F € 3.010	C023870W D € 2.355 E € 2.610 F € 2.845	C023871W D € 2.355 E € 2.610 F € 2.845
Cover	D23868 € 340	D23869 € 340	D23870 € 330	D23871 € 330

# SENJA SOFA DEEP STUDIO SEGERS

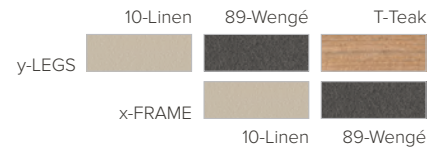

Legs: powdercoated aluminium or teak (set of 4)  
 Pieds: alu peint par poudrage ou teck (set de 4)  
 Poten: gepoedercoat alu of teak (set van 4)

Casual back cushions (C02300W) recommended for optimal comfort  
 Coussins de dos casual (C02300W) recommandés pour un confort optimal  
 Casual rugkussens (C02300W) aanbevolen voor optimaal comfort

	Triple pouf module	Triple module	3-Seater arm high	3-Seater arm low	3-Seater right arm low
Frame	023951-x-y € 1.620	023952-x-y € 2.520	023953-x-y € 3.140	023954-x-y € 3.120	023955-x-y € 3.130
Cushion	C023951W D € 2.235 E € 2.515 F € 2.755	C023952W D € 4.480 E € 5.050 F € 5.535	C023953W D € 6.040 E € 6.820 F € 7.515	C023954W D € 5.840 E € 6.510 F € 7.115	C023955W D € 5.940 E € 6.665 F € 7.315
Cover	D23951 € 420	D23952 € 485	D23953 € 555	D23954 € 565	D23955 € 570

	3-Seater left arm low	Right extension + pouf	Left extension + pouf	Right extension + teak table	Left extension + teak table
Frame	023956-x-y € 3.130	023957-x-y € 2.220	023958-x-y € 2.220	023959-x-y-T € 3.415	023960-x-y-T € 3.415
Cushion	C023956W D € 5.940 E € 6.665 F € 7.315	C023957W D € 3.735 E € 4.205 F € 4.615	C023958W D € 3.735 E € 4.205 F € 4.615	C023959W D € 3.105 E € 3.495 F € 3.835	C023960W D € 3.105 E € 3.495 F € 3.835
Cover	D23956 € 570	D23957 € 465	D23958 € 465	D23959 € 465	D23960 € 465

	Right corner arm high	Left corner arm high	Right corner arm low	Left corner arm low
Frame	023961-x-y € 2.830	023962-x-y € 2.830	023963-x-y € 2.820	023964-x-y € 2.820
Cushion	C023961W D € 5.260 E € 5.935 F € 6.525	C023962W D € 5.260 E € 5.935 F € 6.525	C023963W D € 5.160 E € 5.780 F € 6.325	C023964W D € 5.160 E € 5.780 F € 6.325
Cover	D23961 € 540	D23962 € 540	D23963 € 530	D23964 € 530

	Right corner arm high + pouf	Left corner arm high + pouf	Right corner arm low + pouf	Left corner arm low + pouf
Frame	023965-x-y € 2.530	023966-x-y € 2.530	023967-x-y € 2.520	023968-x-y € 2.520
Cushion	C023965W D € 4.515 E € 5.090 F € 5.605	C023966W D € 4.515 E € 5.090 F € 5.605	C023967W D € 4.415 E € 4.935 F € 5.405	C023968W D € 4.415 E € 4.935 F € 5.405
Cover	D23965 € 490	D23966 € 490	D23967 € 485	D23968 € 485

	Right corner arm high + teak table	Left corner arm high + teak table	Right corner arm low + teak table	Left corner arm low + teak table
Frame	023969-x-y-T € 3.725	023970-x-y-T € 3.725	023971-x-y-T € 3.715	023972-x-y-T € 3.715
Cushion	C023969W D € 3.885 E € 4.380 F € 4.825	C023970W D € 3.885 E € 4.380 F € 4.825	C023971W D € 3.785 E € 4.225 F € 4.625	C023972W D € 3.785 E € 4.225 F € 4.625
Cover	D23969 € 490	D23970 € 490	D23971 € 485	D23972 € 485



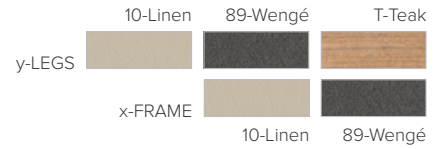

**NEW**

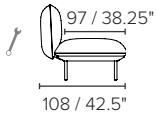

Powdercoated aluminium  
Aluminium peint par poudre  
Gepoedercoat aluminium

Legs: powdercoated alu or teak (set of 4)  
Pieds: aluminium ou teck (set de 4)  
Poten: gepoedercoat alu of teak (set van 4)

Casual back cushions (C02300W) recommended for optimal comfort  
Coussins de dos Casual (C02300W) recommandés pour un confort optimal  
Casual rugkussens (C02300W) aanbevolen voor optimaal comfort

	Pouf module	Single module*	Double module	
Frame	023500-x-y € 1.180	023501-x-y € 1.480	023502-x-y € 1.780	
Cushion	C023500W D € 1.370 E € 1.580 F € 1.790	C023501W D € 2.030 E € 2.375 F € 2.710	C023502W D € 2.690 E € 3.170 F € 3.630	
Cover	D23500 € 310	D23501 € 325	D23502 € 350	*This module can also be mirrored. *Ce module peut également être mis en miroir. *Deze module kan ook gespiegeld worden.

	Right corner arm high	Left corner arm high	Right corner arm low	Left corner arm low
Frame	023503-x-y € 2.075	023504-x-y € 2.075	023505-x-y € 2.055	023506-x-y € 2.055
Cushion	C023503W D € 3.260 E € 3.855 F € 4.425	C023504W D € 3.260 E € 3.855 F € 4.425	C023505W D € 3.175 E € 3.730 F € 4.260	C023506W D € 3.175 E € 3.730 F € 4.260
Cover	D23503 € 390	D23504 € 390	D23505 € 375	D23506 € 375

	2-Arm - arm high	2-Arm - arm low
Frame	023507-x-y € 2.370	023508-x-y € 2.330
Cushion	C023507W D € 3.830 E € 4.540 F € 5.220	C023508W D € 3.660 E € 4.290 F € 4.890
Cover	D23507 € 410	D23508 € 405

# SENJA SOFA MERIDIENNE STUDIO SEGERS

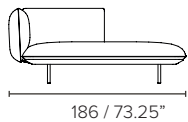
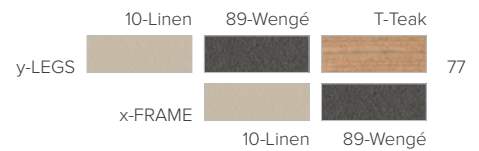

Powdercoated aluminium / Aluminium peint par poudre / Gepoedercoat aluminium  
 Legs: powdercoated alu or teak (set of 4) / Pieds: aluminium ou teck (set de 4) / Poten: gepoedercoat alu of teak (set van 4)  
 Casual back cushions (C02300W) recommended for optimal comfort / Coussins de dos Casual (C02300W) recommandés pour un confort optimal / Casual rugkussens (C02300W) aanbevolen voor optimaal comfort

	Meridienne left arm high	Meridienne left arm low	Meridienne right arm high	Meridienne right arm low	Meridienne daybed
Frame	023301-x-y € 1.830	023302-x-y € 1.825	023401-x-y € 1.830	023402-x-y € 1.825	023403-x-y € 1.530
Cushion	C023301W D € 3.135 E € 3.540 F € 3.890	C023302W D € 3.025 E € 3.380 F € 3.700	C023401W D € 3.135 E € 3.540 F € 3.890	C023402W D € 3.025 E € 3.380 F € 3.700	C023403W D € 2.355 E € 2.655 F € 2.925
Cover	D23301 € 340	D23302 € 350	D23401 € 340	D23402 € 350	D23403 € 315

Casual back cushion  
 Coussin dossier Casual  
 Casual rugkussen  
 68x45x15cm

C02300W



€ 350 Cat D  
 € 430 Cat E  
 € 480 Cat F

Separate Arm/Backrests  
 Dossiers/Accoudoirs séparés  
 Aparte Arm/Rugsteunen

Price on request  
 Prix sur demande  
 Prijs op aanvraag

Console table  
 Table de console  
 Console tafel

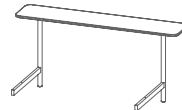
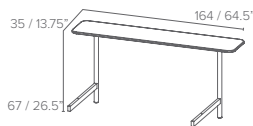

Table: glazed lava stone or teak  
 Table: pierre de lave émaillée ou teck  
 Tafel: geëmailleerde lavasteen of teak



€ 2.880 Lava stone

02387-10-Lx

02387-89-Lx

€ 1.260 Teak

02387-10-T

02387-89-T

D2387CONSOLE

Cover  
 Housse  
 Hoës  
 € 135

Side table  
 Table d'appoint  
 Zijtafeltje

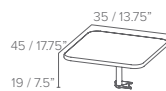

€ 1.445 Lava stone

02381-10-Lx

02381-89-Lx

€ 525 teak

02381-10-T

02381-89-T

D2381SIDE

Cover  
 Housse  
 Hoës  
 € 135

Table top regular  
 Dessus de table standard  
 Tafelblad standaard



Table: glazed lava stone or teak  
 Table: pierre de lave émaillée ou teck  
 Tafel: geëmailleerde lavasteen of teak

+€ 2.065 Lava stone

02370S-10-Lx

02370S-89-Lx



Table top deep  
 Dessus de table profonde  
 Tafelblad diep



+€ 2.195 Lava stone

02370D-10-Lx

02370D-89-Lx

This is an additional cost versus the price for teak (regular p72-73 & deep p74-75)  
 Ceci est un coût supplémentaire vs le prix pour teck (standard p72-73 & profonde p74-75)  
 Dit is een bijkomende kost tov de prijs voor teak (regular p72-73 & deep p74-75)



The specified table tops are in teak. For lava stone there is an additional cost.  
 Les dessus de table mentionnés sont en teck. Pour la pierre de lave, il y a un supplément.  
 De vermelde tafeltops zijn in teak. Voor lavasteen is er een meerkost.

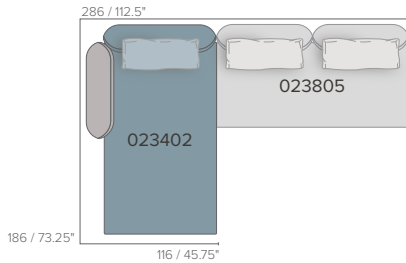
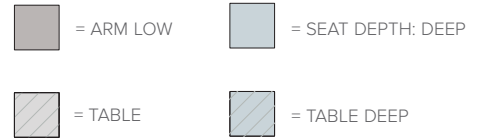

**SET 1**  
 Frame: 023402 + 023805  
 Cushions: C023402W + C023805W  
 Casual back cushions: 3x C02300W

Total price: Cat. D **€ 10.400** E **€ 11.390** F **€ 12.200**  
 Total price without casual back: Cat. D **€ 9.350** E **€ 10.100** F **€ 10.760**  
 Cover: D2301 **€ 655**

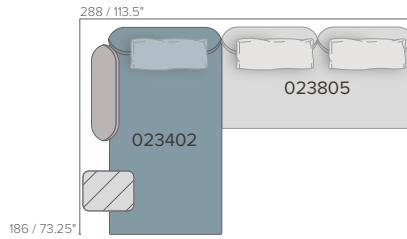

**SET 2**  
 Frame: 023402 + 023805  
 Cushions: C023402W + C023805W  
 Sidetable: 02381-T  
 Casual back cushions: 3x C02300W

Total price: Cat. D **€ 10.925** E **€ 11.915** F **€ 12.725**  
 Total price without casual back: Cat. D **€ 9.875** E **€ 10.625** F **€ 11.285**  
 Lava stone top **+€ 920**  
 Cover: D2302 **€ 655**

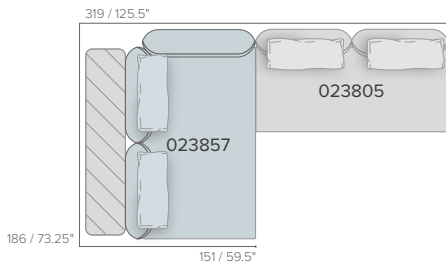

**SET 3**  
 Frame: 023857 + 023805  
 Cushions: C023857W + C023805  
 Table: 02387-T  
 Casual back cushions: 4x C02300W

Total price: Cat. D **€ 13.175** E **€ 14.390** F **€ 15.365**  
 Total price without casual back: Cat. D **€ 11.775** E **€ 12.670** F **€ 13.445**  
 Lava stone top **+€ 1.620**  
 Cover: D2303 **€ 655**

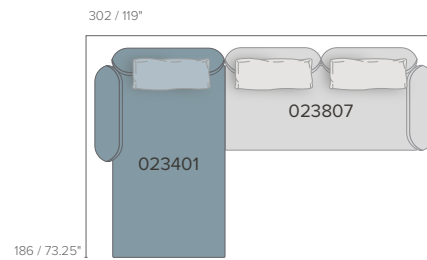

**SET 4**  
 Frame: 023401 + 023807  
 Cushions: C023401W + C023807W  
 Casual back cushions: 3x C02300W

Total price: Cat. D **€ 11.470** E **€ 12.590** F **€ 13.495**  
 Total price without casual back: Cat. D **€ 10.420** E **€ 11.300** F **€ 12.055**  
 Cover: D2304 **€ 655**

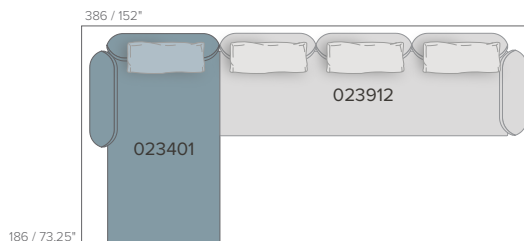

**SET 5**  
 Frame: 023401 + 023912  
 Cushions: C023401W + C023912W  
 Casual back cushions: 4x C02300W

Total price: Cat. D **€ 13.745** E **€ 15.120** F **€ 16.225**  
 Total price without casual back: Cat. D **€ 12.345** E **€ 13.400** F **€ 14.305**  
 Cover: D2305 **€ 820**

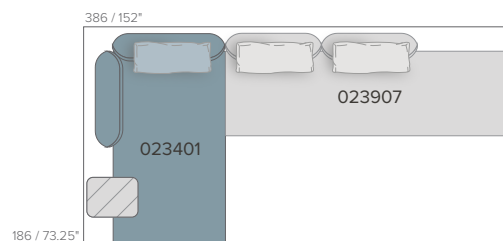

**SET 6**  
 Frame: 023401 + 023907  
 Cushions: C023401W + C023907W  
 Sidetable: 02381-T  
 Casual back cushions: 3x C02300W

Total price: Cat. D **€ 11.910** E **€ 13.030** F **€ 13.950**  
 Total price without casual back: Cat. D **€ 10.860** E **€ 11.740** F **€ 12.510**  
 Lava stone top **+€ 920**  
 Cover: D2306 **€ 820**

Custom covers = 165€ per single seat/table and 330€ for meridienne and daybed modules  
 Housses sur mesure = 165€ par siège simple/table et 330€ pour les modules méridienne et daybed  
 Covers op maat = 165€ per enkele zitplaats/tafel en 330€ voor meridienne en daybed modules

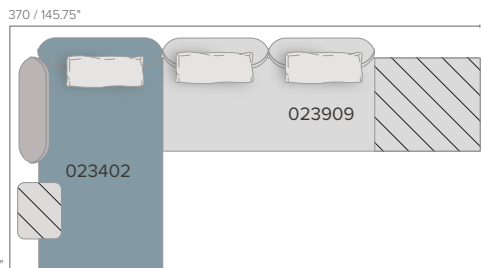
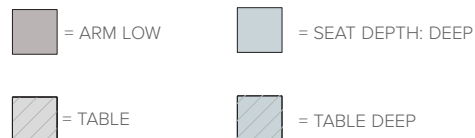

**SET 7A**  
 Frame: 023402 + 023909  
 Cushions: C023402W + C023909W  
 Sidetable: 02381-T  
 Casual back cushions: 3x C02300W

Total price: Cat. D **€ 12.220** E **€ 13.210** F **€ 14.020**  
 Total price without casual back: Cat. D **€ 11.170** E **€ 11.920** F **€ 12.580**  
 Lava stone top **+€ 2.985**  
 Cover: D2323 **€ 820**

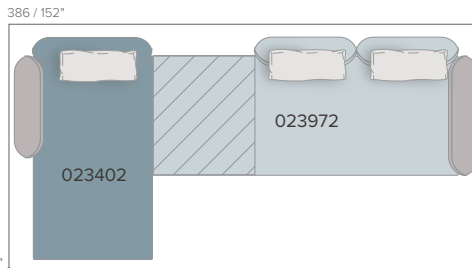

**SET 8A**  
 Frame: 023402 + 023972  
 Cushions: C023402W + C023972W  
 Casual back cushions: 3x C02300W

Total price: Cat. D **€ 13.400** E **€ 14.435** F **€ 15.305**  
 Total price without casual back: Cat. D **€ 12.350** E **€ 13.145** F **€ 13.865**  
 Lava stone top **+€ 2.195**  
 Cover: D2324 **€ 820**

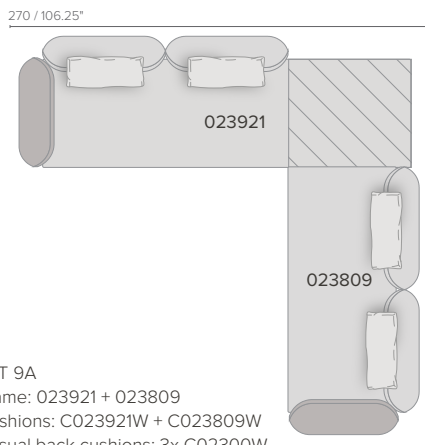

**SET 9A**  
 Frame: 023921 + 023809  
 Cushions: C023921W + C023809W  
 Casual back cushions: 3x C02300W

Total price: Cat. D **€ 13.385** E **€ 14.585** F **€ 15.545**  
 Total price without casual back: Cat. D **€ 11.985** E **€ 12.865** F **€ 13.625**  
 Lava stone top **+€ 2.065**  
 Cover: D2325 **€ 820**

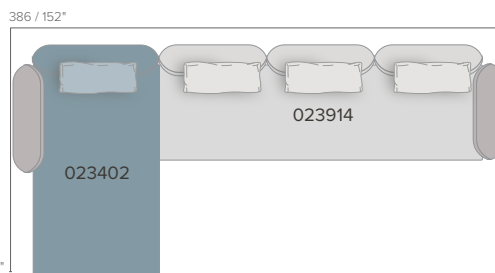

**SET 10A**  
 Frame: 023402 + 023914  
 Cushions: C023402W + C023914W  
 Casual back cushions: 4x C02300W

Total price: Cat. D **€ 13.520** E **€ 14.810** F **€ 15.860**  
 Total price without casual back: Cat. D **€ 12.120** E **€ 13.090** F **€ 13.940**  
 Cover: D2326 **€ 820**

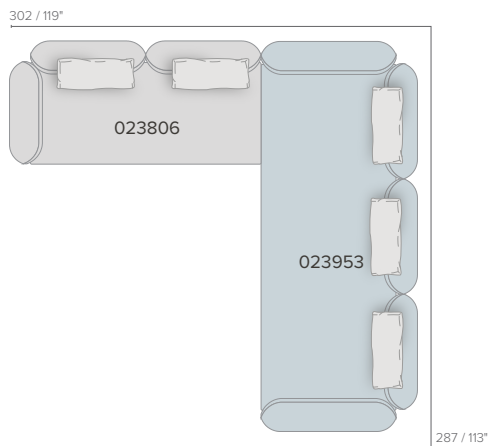

**SET 11A**  
 Frame: 023806 + 023953  
 Cushions: C023806W + C023953W  
 Casual back cushions: 5x C02300W

Total price: Cat. D **€ 16.385** E **€ 18.040** F **€ 19.390**  
 Total price without casual back: Cat. D **€ 14.635** E **€ 15.890** F **€ 16.990**  
 Cover: D2327 **€ 820**

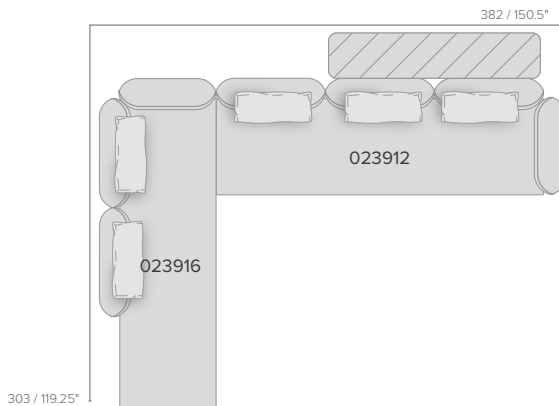

**SET 12**  
 Frame: 023916 + 023912  
 Cushions: C023916W + C023912W  
 Table: 02387-T  
 Casual back cushions: 5x C02300W

Total price: Cat. D **€ 16.715** E **€ 18.320** F **€ 19.610**  
 Total price without casual back: Cat. D **€ 14.965** E **€ 16.170** F **€ 17.210**  
 Lava stone top **+€ 1.620**  
 Cover: D2312 **€ 980**



The table tops mentioned are in teak. For lava stone there is an additional cost.

Les dessus de table mentionnés sont en teck. Pour la pierre de lave, il y a un supplément.

De vermelde tafeltops zijn in teak. Voor lavasteen is er een meerkost.

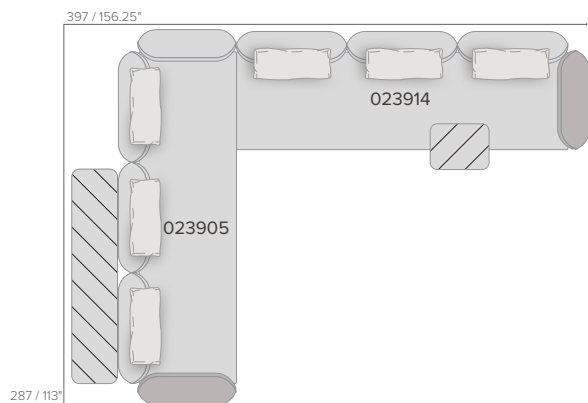
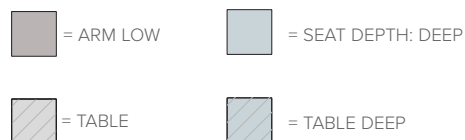

SET 13a

Frame: 023905 + 023914

Cushions: C023905W + C023914W

Sidetable: 02381-T + 02387-T

Casual back cushions: 6x C02300W

Total price: Cat. D € 19.380 E € 21.170 F € 22.595

Total price without casual back: Cat. D € 17.280 E € 18.590 F € 19.715

Lava stone top (2 tables) +€ 2.540

Cover: D2328 € 980

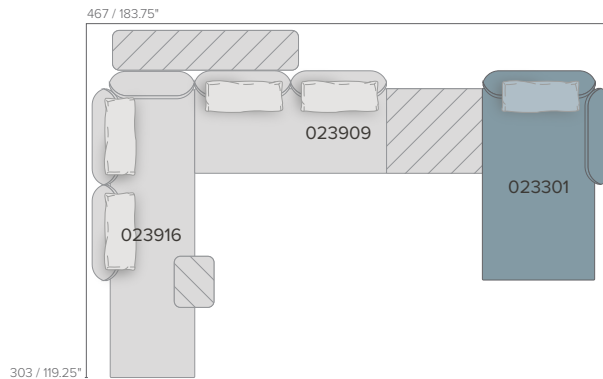

SET 14

Frame: 023916 + 023909 + 023301

Cushions: C023916W + C023909W + C023301W

Tables: 02381-T + 02387-T

Casual back cushions: 5x C02300W

Total price: Cat. D € 20.620 E € 22.375 F € 23.800

Total price without casual back: Cat. D € 18.870 E € 20.225 F € 21.400

Lava stone top (3 tables) +€ 4.605

Cover: D2314 € 1.310

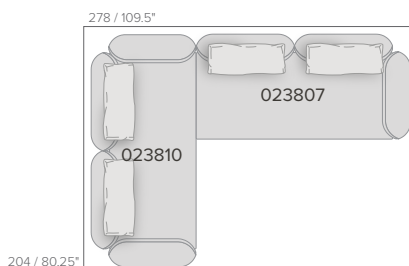

SET 15

Frame: 023810 + 023807

Cushions: C023810W + C023807W

Casual back cushions: 4x C02300W

Total price: Cat. D € 13.265 E € 14.615 F € 15.690

Total price without casual back: Cat. D € 11.865 E € 12.895 F € 13.770

Cover: D2315 € 655

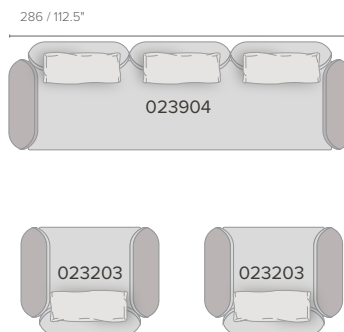

SET 16a

Frame: 023904 + 2x 023203

Cushions: C023904W + 2x C023203W

Casual back cushions: 5x C02300W

Total price: Cat. D € 18.575 E € 20.205 F € 21.555

Total price without casual back: Cat. D € 16.825 E € 18.055 F € 19.155

Cover: D23904 + 2x D23203 € 490 + 2x € 275 = 1.040 €

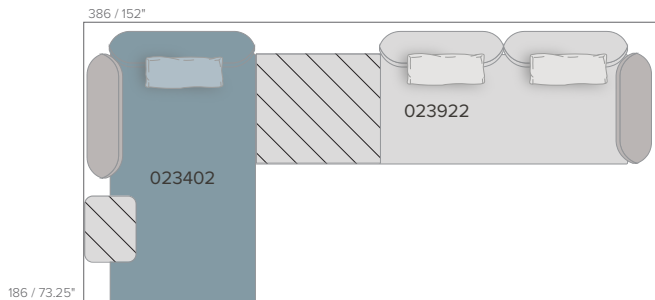

SET 17a

Frame: 023402 + 023922

Cushions: C023402W + C023922W

Sidetable: 02381-T

Casual back cushions: 3x C02300W

Total price: Cat. D € 13.065 E € 14.100 F € 14.950

Total price without casual back: Cat. D € 12.015 E € 12.810 F € 13.510

Lava stone top (2 tables) +€ 2.985

Cover: D2329 € 825

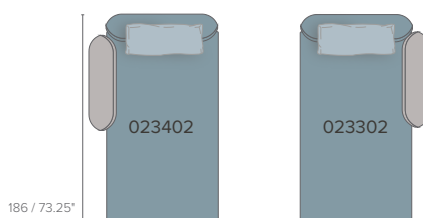

SET 18

Frame: 023402 + 023302

Cushions: C023402W + C023302W

Casual back cushions: 2x C02300W

Total price: Cat. D € 10.400 E € 11.270 F € 12.010

Total price without casual back: Cat. D € 9.700 E € 10.410 F € 11.050

Cover: D23402 + D23302 € 350 + € 350 = 700 €

The table tops mentioned are in teak. For lava stone there is an additional cost.  
 Les dessus de table mentionnés sont en teck. Pour la pierre de lave, il y a un supplément.  
 De vermelde tafeltops zijn in teak. Voor lavasteen is er een meerkost.

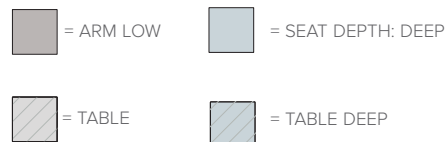

374 / 147.25"

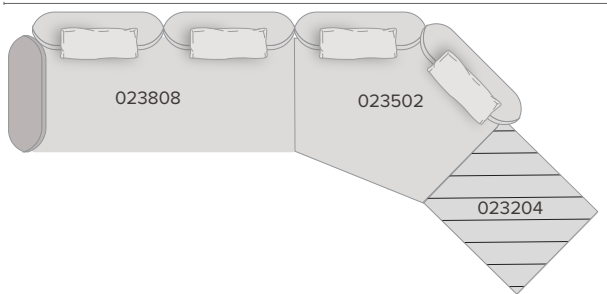

**SET 19a**  
 Frame: 023808 + 023502 + 023204  
 Cushions: C023808W + C023502W  
 Top options: Teak 023204 | Lavastone 023205  
 Casual back cushions: 4x C02300W

Total price Teak top: Cat. D € 12.995 E € 14.235 F € 15.275  
 Total price Teak top without casual back: Cat. D € 11.595 E € 12.515 F € 13.355  
 Total price Lavastone top: Cat. D € 15.060 E € 16.300 F € 17.340  
 Cover: D2330 € 855

462 / 182"

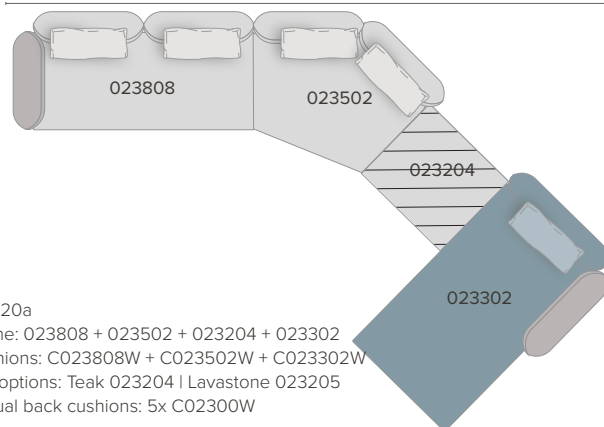

**SET 20a**  
 Frame: 023808 + 023502 + 023204 + 023302  
 Cushions: C023808W + C023502W + C023302W  
 Top options: Teak 023204 | Lavastone 023205  
 Casual back cushions: 5x C02300W

Total price Teak top: Cat. D € 18.195 E € 19.870 F € 21.280  
 Total price Teak top without casual back: Cat. D € 16.445 E € 17.720 F € 18.880  
 Total price Lavastone top: Cat. D € 20.260 E € 21.935 F € 23.345  
 Cover: D2331 € 1.185

403 / 158.75"

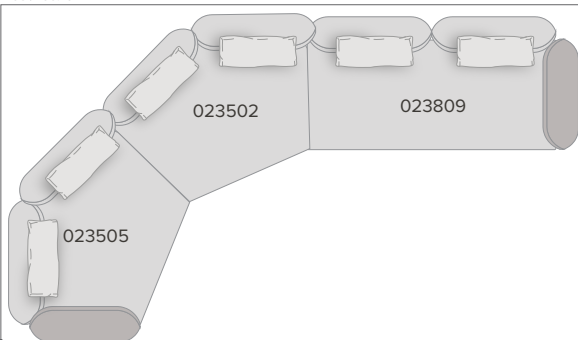

**SET 21a**  
 Frame: 023505 + 023502 + 023809  
 Cushions: C023505W + C023502W + C023809W  
 Casual back cushions: 6x C02300W

Total price: Cat. D € 17.145 E € 19.100 F € 20.770  
 Total price without casual back: Cat. D € 15.045 E € 16.520 F € 17.890  
 Cover: D2332 € 1.250

360 / 141.75"

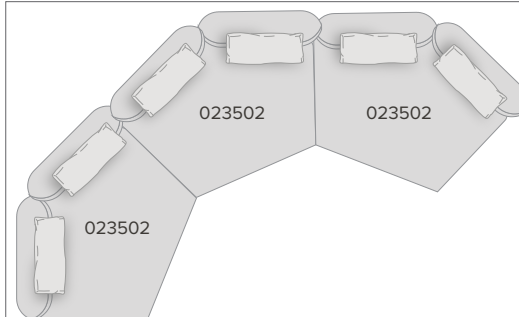

**SET 22a**  
 Frame: 023502 + 023502 + 023502  
 Cushions: 3x C023502W  
 Casual back cushions: 6x C02300W

Total price: Cat. D € 15.510 E € 17.430 F € 19.110  
 Total price without casual back: Cat. D € 13.410 E € 14.850 F € 16.230  
 Cover: D2333 € 1.080

458 / 180.25"

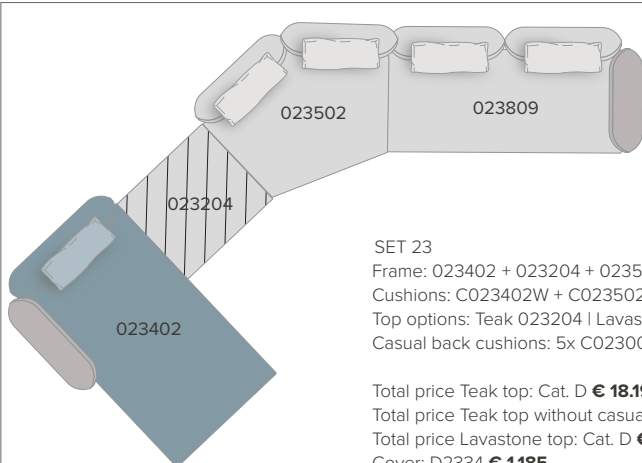

**SET 23**  
 Frame: 023402 + 023204 + 023502 + 023809  
 Cushions: C023402W + C023502W + C023809W  
 Top options: Teak 023204 | Lavastone 023205  
 Casual back cushions: 5x C02300W

Total price Teak top: Cat. D € 18.195 E € 19.870 F € 21.280  
 Total price Teak top without casual back: Cat. D € 16.445 E € 17.720 F € 18.880  
 Total price Lavastone top: Cat. D € 20.260 E € 21.935 F € 23.345  
 Cover: D2334 € 1.185

322 / 126.75"



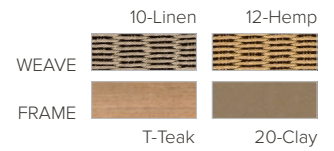

Aluminium, high pressure injected  
Aluminium, moulé sous pression  
Spuitgegoten aluminium

Plantation teak from Java  
Teck de plantation de Java  
Plantageteak uit Java

Trizo Rope  
Trizo Rope  
Trizo Rope

Armchair  
Fauteuil repas  
Armstoel

€ 1.180 Clay



02718-20-12



02718-T-10



02718-T-12



€ 1.595 Teak

**D2718**  
Cover  
Housse  
Hoes  
€ 215

**C02718BW**  
Back cushion  
Coussin dossier  
Rugkussen  
D € 210  
E € 245  
F € 290

**C02718SW**  
Seat cushion  
Coussin d'assise  
Zitkussen  
D € 295  
E € 340  
F € 400



Lounge chair  
Fauteuil lounge  
Lage zetel

€ 1.780 Clay



02712-20-12



02712-T-10



02712-T-12



€ 2.380 Teak

**D2712**  
Cover  
Housse  
Hoes  
€ 230

**C02712BW**  
Back cushion  
Coussin dossier  
Rugkussen  
D € 280  
E € 330  
F € 390

**C02712SW**  
Seat cushion  
Coussin d'assise  
Zitkussen  
D € 405  
E € 450  
F € 535



Aluminium, high pressure injected  
Aluminium, moulé sous pression  
Spuitgegoten aluminium

Plantation teak from Java  
Teck de plantation de Java  
Plantageteak uit Java

Trizo Rope  
Trizo Rope  
Trizo Rope

Banquette

02708-20-10

02708-20-12

€ 3.895

Clay



02708-T-10

02708-T-12

€ 4.995

Teak



**D2708**

Cover  
Housse  
Hoes  
€ 385

**C02708BSETW**

Back cushion Set D € 840  
Coussin dossier Set E € 990  
Rugkussen Set F € 1.170

**C02708SW**

Seat cushion D € 760  
Coussin d'assise E € 895  
Zitkussen F € 1.055



Dining table  
Table à manger  
Eettafel



T-Teak

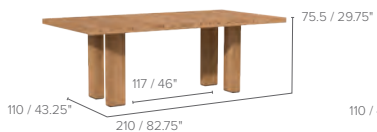

02752-T

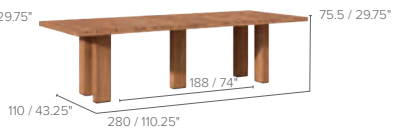

02753-T



02754-T  
02755-T  
02756-T  
02757-T

€ 10.360 210x110cm  
€ 12.950 280x110cm  
€ 21.205 420x110cm  
€ 23.795 490x110cm  
€ 26.385 560x110cm  
€ 31.565 630x110cm



# T-TABLE DINING

## TRIBU STUDIO

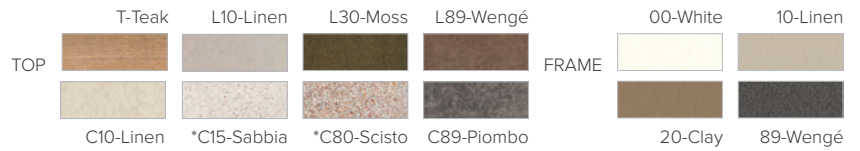

75 / 29.5"  Powdercoated stainless steel  
Inox laqué par poudrage  
Gepoedercoat inox

Table top: glazed lava stone (L), ceramic (C) or teak (T)  
Dessus de table: pierre de lave émaillée (L), céramique (C) ou teck (T)  
Tafelblad: geglazuurde lavasteen (L), keramiek (C) of teak (T)

\*This colour may possibly show veins  
\*Des veines peuvent éventuellement figurer sur cette couleur  
\*Deze kleur kan mogelijk anders vertonen

 Dining table  
Table à manger  
Eettafel

75 / 29.5"



€ 1.790 Ø 80cm  
€ 2.730 Ø 90cm  
€ 3.560 Ø 125cm

D2166-00-T  
D2160-00-T  
D2162-00-T

D2166-10-T  
D2160-10-T  
D2162-10-T

D2166-20-T  
D2160-20-T  
D2162-20-T

D2166-89-T  
D2160-89-T  
D2162-89-T

€ 2.465 Ø 80cm  
€ 3.130 Ø 90cm  
€ 4.850 Ø 125cm

D2166-00-Cx  
D2160-00-Cx  
D2162-00-Cx

D2166-10-Cx  
D2160-10-Cx  
D2162-10-Cx

D2166-20-Cx  
D2160-20-Cx  
D2162-20-Cx

D2166-89-Cx  
D2160-89-Cx  
D2162-89-Cx

€ 3.830 Ø 80cm  
€ 4.850 Ø 90cm  
€ 7.535 Ø 125cm

D2166-00-Lx  
D2160-00-Lx  
D2162-00-Lx

D2166-10-Lx  
D2160-10-Lx  
D2162-10-Lx

D2166-20-Lx  
D2160-20-Lx  
D2162-20-Lx

D2166-89-Lx  
D2160-89-Lx  
D2162-89-Lx

 Dining table  
Table à manger  
Eettafel

76.2 / 30"



€ 3.030 90x90cm  
€ 3.255 90x90cm  
€ 4.980 90x90cm

D2170-00-T  
D2170-00-Cx  
D2170-00-Lx

D2170-10-T  
D2170-10-Cx  
D2170-10-Lx

D2170-20-T  
D2170-20-Cx  
D2170-20-Lx

D2170-89-T  
D2170-89-Cx  
D2170-89-Lx

 Dining table  
Table à manger  
Eettafel

75 / 29.5"



€ 3.495 Elipse - 136 x 80cm  
€ 3.595 Elipse - 136 x 80cm  
€ 5.950 Elipse - 136 x 80cm

D2183-00-T  
D2183-00-Cx  
D2183-00-Lx

D2183-10-T  
D2183-10-Cx  
D2183-10-Lx

D2183-20-T  
D2183-20-Cx  
D2183-20-Lx

D2183-89-T  
D2183-89-Cx  
D2183-89-Lx

 \*Dining table  
\*Table à manger  
\*Eettafel

75.2 / 29.5"



€ 6.855 240x98cm  
€ 7.685 298x98cm

D2175-00-T  
D2176-00-T

D2175-10-T  
D2176-10-T

D2175-20-T  
D2176-20-T

D2175-89-T  
D2176-89-T

€ 6.990 240x98cm  
€ 7.950 298x98cm

D2175-00-Cx  
D2176-00-Cx

D2175-10-Cx  
D2176-10-Cx

D2175-20-Cx  
D2176-20-Cx

D2175-89-Cx  
D2176-89-Cx

\* No lavastone top

Note: the height and clearance under the table may differ according to the type of table top. Please consult the product sheet on our website.

Remarque: la hauteur et le dégagement sous la table peuvent différer selon le type de dessus de table. Pour plus de détails, consultez la fiche produit sur notre site internet.

Opmerking: afhankelijk van het type tafelblad kunnen de hoogte en de vrije ruimte onder de tafel verschillen. Details vindt u op de productfiche op onze website.

# T-TABLE LOW DINING

## TRIBU STUDIO

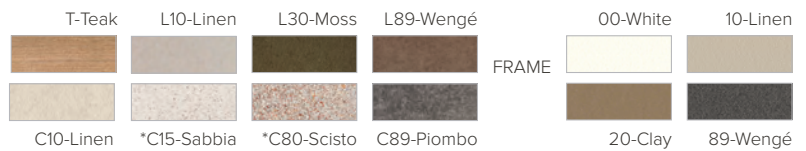

85

67 / 26.5" Powdercoated stainless steel  
Inox laqué par poudrage  
Gepoedercoat inox

Table top: glazed lava stone (L), ceramic (C) or teak (T)  
Dessus de table: pierre de lave émaillée (L), céramique (C) ou teak (T)  
Tafelblad: geglazuurde lavasteen (L), keramiek (C) of teak (T)

\*This colour may possibly show veins.  
\*Des veines peuvent éventuellement figurer sur cette couleur  
\*Deze kleur kan mogelijk anders vertonen.

Low dining table  
Table à manger basse  
Lage eettafel

68 / 26.75"



€ 1.790 Ø 80cm  
€ 2.730 Ø 90cm  
€ 3.560 Ø 125cm

D2167-00-T  
D2161-00-T  
D2163-00-T

D2167-10-T  
D2161-10-T  
D2163-10-T

D2167-20-T  
D2161-20-T  
D2163-20-T

D2167-89-T  
D2161-89-T  
D2163-89-T

€ 2.465 Ø 80cm  
€ 3.130 Ø 90cm  
€ 4.850 Ø 125cm

D2167-00-Cx  
D2161-00-Cx  
D2163-00-Cx

D2167-10-Cx  
D2161-10-Cx  
D2163-10-Cx

D2167-20-Cx  
D2161-20-Cx  
D2163-20-Cx

D2167-89-Cx  
D2161-89-Cx  
D2163-89-Cx

€ 3.830 Ø 80cm  
€ 4.850 Ø 90cm  
€ 7.535 Ø 125cm

D2167-00-Lx  
D2161-00-Lx  
D2163-00-Lx

D2167-10-Lx  
D2161-10-Lx  
D2163-10-Lx

D2167-20-Lx  
D2161-20-Lx  
D2163-20-Lx

D2167-89-Lx  
D2161-89-Lx  
D2163-89-Lx

Low dining table  
Table à manger basse  
Lage eettafel

68.2 / 26.75"



€ 3.030 90x90cm  
€ 3.255 90x90cm  
€ 4.980 90x90cm

D2172-00-T  
D2172-00-Cx  
D2172-00-Lx

D2172-10-T  
D2172-10-Cx  
D2172-10-Lx

D2172-20-T  
D2172-20-Cx  
D2172-20-Lx

D2172-89-T  
D2172-89-Cx  
D2172-89-Lx

Low Dining table  
Table à manger basse  
Lage eettafel

68 / 26.75"



€ 3.495 Elipse - 136 x 80cm  
€ 3.595 Elipse - 136 x 80cm  
€ 5.950 Elipse - 136 x 80cm

D2184-00-T  
D2184-00-Cx  
D2184-00-Lx

D2184-10-T  
D2184-10-Cx  
D2184-10-Lx

D2184-20-T  
D2184-20-Cx  
D2184-20-Lx

D2184-89-T  
D2184-89-Cx  
D2184-89-Lx

\*Low dining table  
\*Table à manger basse  
\*Lage eettafel

67.2 / 26.5"



€ 6.855 240x98cm  
€ 7.685 298x98cm

D2177-00-T  
D2178-00-T

D2177-10-T  
D2178-10-T

D2177-20-T  
D2178-20-T

D2177-89-T  
D2178-89-T

€ 6.990 240x98cm  
€ 7.950 298x98cm

D2177-00-Cx  
D2178-00-Cx

D2177-10-Cx  
D2178-10-Cx

D2177-20-Cx  
D2178-20-Cx

D2177-89-Cx  
D2178-89-Cx

\* No lavastone top

Note: the height and clearance under the table may differ according to the type of table top. Please consult the product sheet on our website.

Remarque: la hauteur et le dégagement sous la table peuvent différer selon le type de dessus de table. Pour plus de détails, consultez la fiche produit sur notre site internet.

Opmerking: afhankelijk van het type tafelblad kunnen de hoogte en de vrije ruimte onder de tafel verschillen. Details vindt u op de productfiche op onze website.

Covers for tables see p.124-127  
Des housses pour les tables voir p.124-127  
Hoezen voor tafels zie p.124-127



# T-TABLE LOW DINING

## TRIBU STUDIO

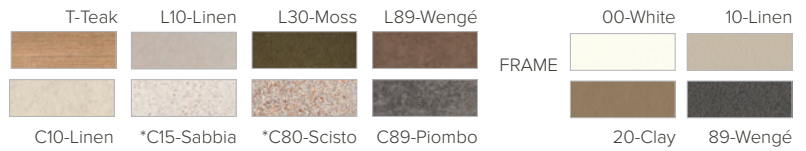

Powdercoated stainless steel  
Inox laqué par poudrage  
Gepoedercoat inox

Table top: glazed lava stone (L), ceramic (C) or teak (T)  
Dessus de table: pierre de lave émaillée (L), céramique (C) ou teak (T)  
Tafelblad: geglazuurde lavasteen (L), keramiek (C) of teak (T)

\*This colour may possibly show veins.  
\*Des veines peuvent éventuellement figurer sur cette couleur  
\*Deze kleur kan mogelijk anders vertonen.



Low dining table  
Table à manger basse  
Lage eettafel

64 / 25.25"



€ 1.790 Ø 80cm  
€ 2.730 Ø 90cm  
€ 3.560 Ø 125cm

D2190-00-T  
D2191-00-T  
D2192-00-T

D2190-10-T  
D2191-10-T  
D2192-10-T

D2190-20-T  
D2191-20-T  
D2192-20-T

D2190-89-T  
D2191-89-T  
D2192-89-T

€ 2.465 Ø 80cm  
€ 3.130 Ø 90cm  
€ 4.850 Ø 125cm

D2190-00-Cx  
D2191-00-Cx  
D2192-00-Cx

D2190-10-Cx  
D2191-10-Cx  
D2192-10-Cx

D2190-20-Cx  
D2191-20-Cx  
D2192-20-Cx

D2190-89-Cx  
D2191-89-Cx  
D2192-89-Cx

€ 3.830 Ø 80cm  
€ 4.850 Ø 90cm  
€ 7.535 Ø 125cm

D2190-00-Lx  
D2191-00-Lx  
D2192-00-Lx

D2190-10-Lx  
D2191-10-Lx  
D2192-10-Lx

D2190-20-Lx  
D2191-20-Lx  
D2192-20-Lx

D2190-89-Lx  
D2191-89-Lx  
D2192-89-Lx



Low dining table  
Table à manger basse  
Lage eettafel

64 / 25.25"



€ 3.030 90x90cm  
€ 3.255 90x90cm  
€ 4.980 90x90cm

D2193-00-T  
D2193-00-Cx  
D2193-00-Lx

D2193-10-T  
D2193-10-Cx  
D2193-10-Lx

D2193-20-T  
D2193-20-Cx  
D2193-20-Lx

D2193-89-T  
D2193-89-Cx  
D2193-89-Lx



Low Dining table  
Table à manger basse  
Lage eettafel

64 / 25.25"



€ 3.495 Elipse - 136 x 80cm  
€ 3.595 Elipse - 136 x 80cm  
€ 5.950 Elipse - 136 x 80cm

D2194-00-T  
D2194-00-Cx  
D2194-00-Lx

D2194-10-T  
D2194-10-Cx  
D2194-10-Lx

D2194-20-T  
D2194-20-Cx  
D2194-20-Lx

D2194-89-T  
D2194-89-Cx  
D2194-89-Lx



\*Low dining table  
\*Table à manger basse  
\*Lage eettafel

64 / 25.25"



€ 6.855 240x98cm  
€ 7.685 298x98cm

D2195-00-T  
D2196-00-T

D2195-10-T  
D2196-10-T

D2195-20-T  
D2196-20-T

D2195-89-T  
D2196-89-T

€ 6.990 240x98cm  
€ 7.950 298x98cm

D2195-00-Cx  
D2196-00-Cx

D2195-10-Cx  
D2196-10-Cx

D2195-20-Cx  
D2196-20-Cx

D2195-89-Cx  
D2196-89-Cx

\* No lavastone top

Note: the height and clearance under the table may differ according to the type of table top. Please consult the product sheet on our website.

Remarque: la hauteur et le dégagement sous la table peuvent différer selon le type de dessus de table. Pour plus de détails, consultez la fiche produit sur notre site internet.

Opmerking: afhankelijk van het type tafelblad kunnen de hoogte en de vrije ruimte onder de tafel verschillen. Details vindt u op de productfiche op onze website.

# T-TABLE COFFEE

## TRIBU STUDIO

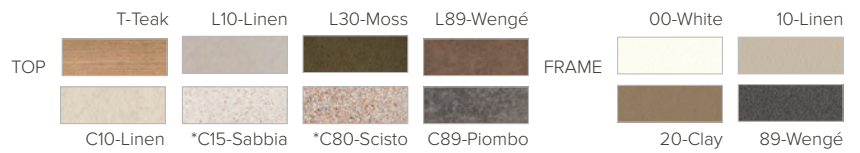

87



35 / 13,75  Powdercoated stainless steel  
Inox laqué par poudrage  
Gepoedercoat inox

Table top: glazed lava stone (L), ceramic (C) or teak (T)  
Dessus de table: pierre de lave émaillée (L), céramique (C) ou teck (T)  
Tafelblad: geglazuurde lavasteen (L), keramiek (C) of teak (T)

\*This colour may possibly show veins.  
\*Des veines peuvent éventuellement figurer sur cette couleur

\*Deze kleur kan mogelijk anders vertonen.

 Coffee table  
Table de salon  
Koffietafel

35 / 13,75



€ 1.790 Ø 80cm  
€ 2.730 Ø 90cm  
€ 3.560 Ø 125cm

D2168-00-T  
D2164-00-T  
D2165-00-T

D2168-10-T  
D2164-10-T  
D2165-10-T

D2168-20-T  
D2164-20-T  
D2165-20-T

D2168-89-T  
D2164-89-T  
D2165-89-T

€ 2.465 Ø 80cm  
€ 3.130 Ø 90cm  
€ 4.850 Ø 125cm

D2168-00-Cx  
D2164-00-Cx  
D2165-00-Cx

D2168-10-Cx  
D2164-10-Cx  
D2165-10-Cx

D2168-20-Cx  
D2164-20-Cx  
D2165-20-Cx

D2168-89-Cx  
D2164-89-Cx  
D2165-89-Cx

€ 3.830 Ø 80cm  
€ 4.850 Ø 90cm  
€ 7.250 Ø 125cm

D2168-00-Lx  
D2164-00-Lx  
D2165-00-Lx

D2168-10-Lx  
D2164-10-Lx  
D2165-10-Lx

D2168-20-Lx  
D2164-20-Lx  
D2165-20-Lx

D2168-89-Lx  
D2164-89-Lx  
D2165-89-Lx

 Coffee table  
Table de salon  
Koffietafel

35 / 13,75



€ 3.030 90x90cm  
€ 3.255 90x90cm  
€ 4.980 90x90cm

D2174-00-T  
D2174-00-Cx  
D2174-00-Lx

D2174-10-T  
D2174-10-Cx  
D2174-10-Lx

D2174-20-T  
D2174-20-Cx  
D2174-20-Lx

D2174-89-T  
D2174-89-Cx  
D2174-89-Lx

 Coffee table  
Table de salon  
Koffietafel

35 / 13,75\*



€ 3.495 Elipse - 136 x 80cm  
€ 3.595 Elipse - 136 x 80cm  
€ 5.950 Elipse - 136 x 80cm

D2185-00-T  
D2185-00-Cx  
D2185-00-Lx

D2185-10-T  
D2185-10-Cx  
D2185-10-Lx

D2185-20-T  
D2185-20-Cx  
D2185-20-Lx

D2185-89-T  
D2185-89-Cx  
D2185-89-Lx

 \*Coffee table  
\*Table de salon  
\*Koffietafel

35 / 13,75



€ 6.855 240x98cm  
€ 7.685 298x98cm

D2179-00-T  
D2180-00-T

D2179-10-T  
D2180-10-T

D2179-20-T  
D2180-20-T

D2179-89-T  
D2180-89-T

€ 6.990 240x98cm  
€ 7.950 298x98cm

D2179-00-Cx  
D2180-00-Cx

D2179-10-Cx  
D2180-10-Cx

D2179-20-Cx  
D2180-20-Cx

D2179-89-Cx  
D2180-89-Cx

\* No lavastone top

Note: the height and clearance under the table may differ according to the type of table top. Please consult the product sheet on our website.

Remarque: la hauteur et le dégagement sous la table peuvent différer selon le type de dessus de table. Pour plus de détails, consultez la fiche produit sur notre site internet.

Opmerking: afhankelijk van het type tafelblad kunnen de hoogte en de vrije ruimte onder de tafel verschillen. Details vindt u op de productfiche op onze website.



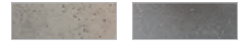

Lightened concrete  
Béton allégé  
Verlicht beton

This material is sensitive to stains  
Ce matériau est sensible aux taches  
Dit materiaal is vlekgevoelig

 Dining Table  
Table à manger  
Eettafel



€ 6.450  
€ 7.750

Ø 160cm  
Ø 180cm

01666-10  
01668-10

01666-89  
01668-89

 Dining Table  
Table à manger  
Eettafel



€ 8.350

Oval

01670-10

01670-89

Weight filling bag included  
Sac de remplissage inclus  
Verzwarende zak voor stabiliteit inclusief

 Coffee Table  
Table de salon  
Koffietafel

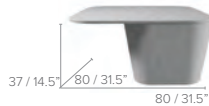

€ 2.495

01682-10

01682-89

Powdercoated stainless steel  
Inox laqué par poudrage  
Gepoedercoat inox

Braiding: foam in a knitted sheath of Tricord® (polyofin) and textile  
Tressage: mousse dans une housse tricotée de Tricord® (polyoléfine) et textile  
Vlechtwerk: schuim in een gebreide hoes van Tricord® (polyolefine) en textiel

Seat support: Batyline  
Support d'assise: Batyline  
Zitvlak: Batyline

Armchair  
Fauteuil repas  
Armstoel

€ 1.460

05318-10



05318-89



**D5318**  
Cover  
Housse  
Hoes  
€ 180

**C05318BW**  
Back cushion  
Coussin dossier  
Rugkussen  
D € 140  
E € 160  
F € 210

**C05318SW**  
Seat cushion  
Coussin d'assise  
Zitkussen  
D € 175  
E € 230  
F € 320



Counter height chair  
Fauteuil à hauteur de comptoir  
Stoel aanrechthoogte

€ 1.690

05315-10



05315-89



**D5315**  
Cover  
Housse  
Hoes  
€ 215

**C05318BW**  
Back cushion  
Coussin dossier  
Rugkussen  
D € 140  
E € 160  
F € 210

**C05315SW**  
Seat cushion  
Coussin d'assise  
Zitkussen  
D € 180  
E € 235  
F € 330





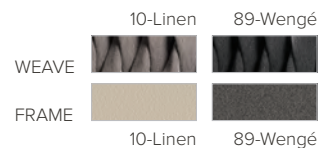

Powdercoated stainless steel  
Inox laqué par poudrage  
Gepoedercoat inox

Braiding: foam in a knitted sheath of Tricord® (polyofin) and textilene  
Tressage: mousse dans une housse tricotée de Tricord® (polyoléfine) et textilène  
Vlechtwerk: schuim in een gebreide hoese van Tricord® (polyolefine) en textileen

Seat support: Batyline  
Support d'assise: Batyline  
Zitvlak: Batyline

Low dining chair  
Fauteuil low dining  
Stoel low dining

05317-10

05317-89

€ 2.490

**D5317**

Cover  
Housse  
Hoes  
€ 240

**C05317BW**

Back cushion D € 270  
Coussin dossier E € 310  
Rugkussen F € 360

**C05317SW**

Seat cushion D € 435  
Coussin d'assise E € 480  
Zitkussen F € 555



Lounge chair  
Fauteuil Lounge  
Lage zetel

05302-10

05302-89

€ 3.540

**D5302**

Cover  
Housse  
Hoes  
€ 230

**C05302BW**

Back cushion D € 295  
Coussin dossier E € 335  
Rugkussen F € 385

**C05302SW**

Seat cushion D € 690  
Coussin d'assise E € 725  
Zitkussen F € 795

**C0013W**

Option lumbar cushion D € 100  
Option coussin lombaire E € 120  
Optie lendenkussen F € 140



Powdercoated stainless steel  
Inox laqué par poudrage  
Gepoedercoat inox

Braiding: foam in a knitted sleeve of Tricord® (polyofin) and textile  
Tressage: mousse dans une housse tricotée de Tricord® (polyoléfine) et textile  
Vlechtwerk: schuim in een gebreide hoes van Tricord® (polyolefine) en textiel

Seat support: Batyline  
Support d'assise: Batyline  
Zitvlak: Batyline

2-Seater sofa  
Canapé 2 places  
Sofa 2-zit

€ 5.095



**D5308**  
Cover  
Housse  
Hoes  
€ 305

**C05308BW**

Back cushion  
Coussin dossier  
Rugkussen

D € 295  
E € 335  
F € 385

(order 2x!)

**C05308SW**

Seat cushion  
Coussin d'assise  
Zitkussen

D € 1.090  
E € 1.165  
F € 1.250



**C0013W**

Option lumbar cushion  
Option coussin lombaire  
Optie lendenkussen

D € 100  
E € 120  
F € 140



3-Seater sofa  
Canapé 3 places  
Sofa 3-zit

€ 6.845



**D5309**  
Cover  
Housse  
Hoes  
€ 375

**C05309BW**

Back cushion  
Coussin dossier  
Rugkussen

D € 295  
E € 335  
F € 385

(order 3x!)

**C05309SW**

Seat cushion  
Coussin d'assise  
Zitkussen

D € 1.475  
E € 1.590  
F € 1.705



**C0013W**

Option lumbar cushion  
Option coussin lombaire  
Optie lendenkussen

D € 100  
E € 120  
F € 140





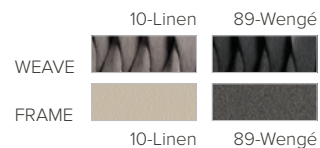

Powdercoated stainless steel  
Inox laqué par poudrage  
Gepoedercoat inox

Braiding: foam in a knitted sleeve of Tricord® (polyofin) and textilene  
Tressage: mousse dans une housse tricotée de Tricord® (polyoléfine) et textilène  
Vlechtwerk: schuim in een gebreide hoos van Tricord® (polyolefine) en textileen

Seat support: Batyline  
Support d'assise: Batyline  
Zitvlak: Batyline

Adjustable lounger  
Chaise longue réglable  
Ligbed, verstelbaar

€ 4.840



**D5340**  
Cover  
Housse  
Hoes  
€ 325

**C05340W**  
Cushion  
Coussin  
Kussen  
D € 885  
E € 940  
F € 1.010



Daybed  
Daybed  
Daybed

€ 10.590



**D5349**  
Cover  
Housse  
Hoes  
€ 385

**C05349BW**  
Back cushion  
Coussin dossier  
Rugkussen  
70x60cm, order 3x!  
D € 260  
E € 305  
F € 345

**C05349SW**  
Seat cushion  
Coussin d'assise  
Zitkussen  
D € 1.840  
E € 2.030  
F € 2.195



For optimal comfort, we recommend completing the Daybed with 3 backs and several deco cushions (p. 115)

Pour une ambiance confortable, nous recommandons de compléter le Daybed avec 3 coussins dossier et plusieurs coussins déco (page 115)

Voor een gezellig gevoel, raden wij aan het Daybed te vullen met 3 rugkussens en verschillende decokussens (pag. 115)

Powdercoated stainless steel  
Inox laqué par poudrage  
Gepoedercoat inox

Table top: ceramic  
Dessus de table: céramique  
Tafelblad: keramiek

\*This colour may possibly show veins  
\*Des veines peuvent éventuellement figurer sur cette couleur  
\*Deze kleur kan mogelijk anders vertonen

Dining table  
Table à manger  
Eettafel



€ 5.780 240cm  
€ 7.175 298cm

05355-10-xx  
05354-10-xx

05355-89-xx  
05354-89-xx

Low Dining table  
Table low dining  
Tafel low dining

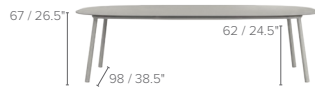

€ 5.660 240cm  
€ 7.055 298cm

05335-10-xx  
05334-10-xx

05335-89-xx  
05334-89-xx

Side table  
Table d'appoint  
Bijzettafel

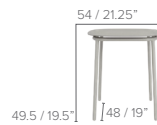

€ 1.480

05381-10-xx

05381-89-xx

Coffee Table  
Table de salon  
Koffietafel

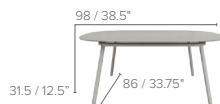

€ 2.485

05386-10-xx

05386-89-xx



Plantation teak from Java  
Teck de plantation de Java  
Plantageteak uit Java

 Armchair  
Fauteuil repas  
Armstoel

€ 1.225



**D7518**  
Cover  
Housse  
Hoes  
€ 200

**C07518W**  
Seat & back cushion D € 375  
Coussin d'assise et de dossier E € 485  
Zit-en rugkussen F € 615

**C07518SW**  
Seat cushion D € 155  
Coussin d'assise E € 215  
Zitkussen F € 285



 Lounge chair  
Fauteuil Lounge  
Lage zetel

€ 1.475



**D7512**  
Cover  
Housse  
Hoes  
€ 220

**C07512BW**  
Back cushion D € 320  
Coussin dossier E € 350  
Rugkussen F € 370

**C07512SW**  
Seat cushion D € 280  
Coussin d'assise E € 355  
Zitkussen F € 450



 Adjustable lounger  
Chaise longue réglable  
Ligbed, verstelbaar

€ 2.240



**D7540**  
Cover  
Housse  
Hoes  
€ 300

**\*C07540W**  
Cushion D € 605  
Coussin E € 865  
Kussen F € 1.165  
\*Head support not included

**C0005W**  
Head support lounger for Ukiyo D € 200  
Repose tête chaise longue pour Ukiyo E € 240  
Hoofdsteun ligbed voor Ukiyo F € 280



Plantation teak from Java  
Teck de plantation de Java  
Plantageteak uit Java

Table top: ceramic  
Dessus de table: céramique  
Tafelblad: keramiek

\*This colour may possibly show veins.  
\*Des veines peuvent éventuellement figurer sur cette couleur  
\*Deze kleur kan mogelijk anders vertonen.

Dining table  
Table à manger  
Eettafel



€ 6.995

07553-xx

Coffee table  
Table de salon  
Koffietafel



€ 2.495

07586-xx

Low table  
Table de salon  
Lage tafel



€ 2.995

07588-xx





Plantation teak from Java  
Teck de plantation de Java  
Plantageteak uit Java

Lounger, adjustable  
Chaise longue, réglable  
Ligbed, verstelbaar

01740  
01740W\*\*\*

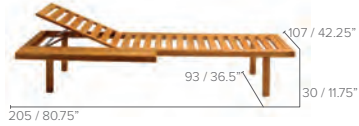

€ 2.605  
€ 345

\*\*\*Set of wheels \*\*\*Set de roues \*\*\*Set wielen

**D6130**

Cover  
Housse  
Hoes  
€ 305

**C01740W**

Cushion D € 1.195  
Coussin E € 1.440  
Kussen F € 1.685

**C01741W**

Project cushion\* D € 835  
Coussin de projet\* E € 1.040  
Projectkussen\* F € 1.205



\* 2 compartment cushion without headrest  
\* Coussin deux compartiments sans repose-tête  
\* 2-delig kussen zonder hoofdsteun

Lounger, adjustable, wheels  
Chaise longue, réglable, roues  
Ligbed, verstelbaar, wielen

01741

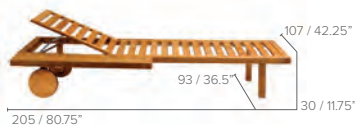

€ 2.890

**D6130**

Cover  
Housse  
Hoes  
€ 305

**C01740W**

Cushion D € 1.195  
Coussin E € 1.440  
Kussen F € 1.685

**C01741W**

Project cushion\* D € 835  
Coussin de projet\* E € 1.040  
Projectkussen\* F € 1.205



\* 2 compartment cushion without headrest  
\* Coussin deux compartiments sans repose-tête  
\* 2-delig kussen zonder hoofdsteun

Dining table  
Table à manger  
Eettafel



€ 2.815 99x99cm  
€ 8.395 300x99cm  
€ 10.725 400x99cm  
€ 13.905 500x99cm\*\*  
€ 16.240 600x99cm\*\*  
€ 18.565 700x99cm\*\*

01773

01753  
01754  
01755  
01756  
01757

\*\* From a length of 5 m or more, a third set of legs is added

\*\* A partir d'une longueur de 5 m ou plus, un troisième set de pattes est ajouté

\*\* Vanaf een lengte van 5 m of meer wordt een derde set poten toegevoegd

Covers for tables see p.124-127  
Des housses pour les tables voir p.124-127  
Hoezen voor tafels zie p.124-127

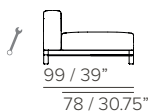

Plantation teak from Java  
Teck de plantation de Java  
Plantageteak uit Java

Brackets for cushions in stainless steel  
Arcs pour les coussins en acier inoxydable  
Beugels voor kussens in inox

Casual back cushions **not included\***  
Coussins dossier Casual **non inclus\***  
Casual rugkussens **niet inbegrepen\***

### Pouf module

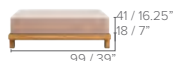

Frame **01792**  
**€ 1.200**

### Extension module single



Frame **01700**  
**€ 1.200**

### Corner module right arm



Frame **01701R**  
**€ 1.200**

### Corner module left arm



Frame **01701L**  
**€ 1.200**

Cushion **C01792W**  
D **€ 1.295**  
E **€ 1.390**  
F **€ 1.600**

Cushion **C01700W**  
D **€ 1.890**  
E **€ 2.030**  
F **€ 2.335**

Cushion **C01701W**  
D **€ 2.535**  
E **€ 2.725**  
F **€ 3.130**

Cushion **C01701W**  
D **€ 2.535**  
E **€ 2.725**  
F **€ 3.130**

Cover **D1792 € 195**

Cover **D1700 € 240**

Cover **D1731R € 285**

Cover **D1731L € 285**

### Center module



Frame **01708**  
**€ 2.090**

### Extension pouf left



Frame **01706L**  
**€ 2.090**

### Extension pouf right



Frame **01706R**  
**€ 2.090**

### Extension module double



Frame **01728**  
**€ 2.090**

Cushion **C01708W**  
D **€ 2.590**  
E **€ 2.780**  
F **€ 3.200**

Cushion **C01706W**  
D **€ 3.185**  
E **€ 3.420**  
F **€ 3.935**

Cushion **C01706W**  
D **€ 3.185**  
E **€ 3.420**  
F **€ 3.935**

Cushion **C01728W**  
D **€ 3.780**  
E **€ 4.060**  
F **€ 4.670**

Cover **D1732 € 330**

Cover **D1730L € 365**

Cover **D1730R € 365**

Cover **D1728 € 365**

### Right arm module



Frame **01738R**  
**€ 2.090**

### Left arm module



Frame **01738L**  
**€ 2.090**

### 2-Seater sofa



Frame **01709**  
**€ 2.090**

Cushion **C01738W**  
D **€ 4.430**  
E **€ 4.755**  
F **€ 5.465**

Cushion **C01738W**  
D **€ 4.430**  
E **€ 4.755**  
F **€ 5.465**

Cushion **C01709W**  
D **€ 5.070**  
E **€ 5.450**  
F **€ 6.260**

Cover **D1738R € 385**

Cover **D1738L € 385**

Cover **D1733 € 385**

### Meridienne right short arm



Frame **01704S**  
**€ 2.090**

### Meridienne left short arm



Frame **01703S**  
**€ 2.090**

### Meridienne right long arm



Frame **01704**  
**€ 2.090**

### Meridienne left long arm



Frame **01703**  
**€ 2.090**

### Daybed module



Frame **01742**  
**€ 2.090**

Cushion **C01704SW**  
D **€ 3.830**  
E **€ 4.115**  
F **€ 4.730**

Cushion **C01703SW**  
D **€ 3.830**  
E **€ 4.115**  
F **€ 4.730**

Cushion **C01704W**  
D **€ 3.830**  
E **€ 4.115**  
F **€ 4.730**

Cushion **C01703W**  
D **€ 3.830**  
E **€ 4.115**  
F **€ 4.730**

Cushion **C01742W**  
D **€ 3.185**  
E **€ 3.420**  
F **€ 3.935**

Cover **D1704S € 385**

Cover **D1703S € 385**

Cover **D1720R € 385**

Cover **D1720L € 385**

Cover **D1742 € 385**





Plantation teak from Java  
Teck de plantation de Java  
Plantageteak uit Java

Casual back cushion  
Coussin dossier Casual  
Casual rugkussen  
63x45x15cm

C0012W



To order separately!  
A commander séparément!  
Apart te bestellen!

€ 345 Cat D  
€ 430 Cat E  
€ 480 Cat F

High backrest cushion\*  
Coussin dossier élevé\*  
Hoog rugkussen\*  
76x60x15cm

C0012BHW



To order separately!  
A commander séparément!  
Apart te bestellen!

\*Support bracket in stainless steel with cover in fabric included  
\*Arc de support en acier inoxydable avec housse en tissu inclus  
\*Steunbeugel in inox met stoffen hoese inbegrepen

€ 695 Cat D  
€ 840 Cat E  
€ 965 Cat F

Coffee table  
Table de salon  
Koffietafel



Cover  
Housse  
Hoes

€ 2.115 99x99cm  
€ 2.700 121x99cm  
€ 3.300 121x121cm  
€ 1.945 159x44cm

01781  
01784  
01786

01732

D1781 € 140  
D1784 € 165  
D1786 € 220  
D1735 € 245

Bench  
Banc  
Bank

01734



€ 1.995 H44cm

C01734W

Cushion D € 545  
Coussin E € 675  
Kussen F € 825

D1734

Cover  
Housse  
Hoes  
€ 245

Options borders H 18cm  
Options modules bord H 18cm  
Optie boorden H 18cm

01700B  
€ 1.950

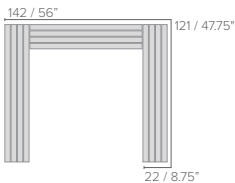

01701B  
€ 1.255

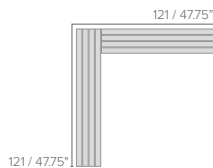

01704B  
€ 1.390

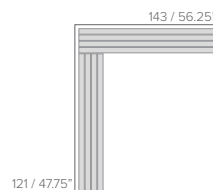

01706B  
€ 1.120



01709B  
€ 2.510

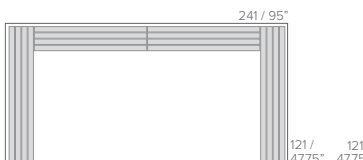

01738B  
€ 1.815

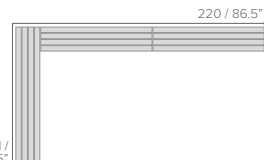

01796B  
€ 560

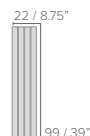

01797B  
€ 695

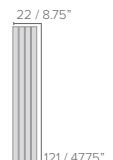

# VIS À VIS SOFA SETS

PIERGIORGIO CAZZANIGA

Custom covers = €165 per single seat and €330 for meridienne and daybed modules  
 Housses sur mesure = €165 par siège simple et €330 pour les modules méridienne et daybed  
 Covers op maat = €165 per enkele zitplaats en €330 voor meridienne en daybed modules

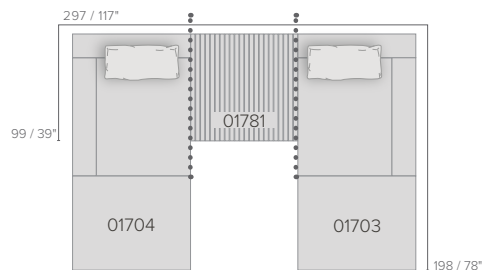

SET 1b  
 frame: 01704 + 01703 + 01781  
 cushions: C01704W + C01703W  
 back cushions: 2x C0012W

total price: Cat. D **€ 14.645 E € 15.385 F € 16.715**  
 price without table: Cat. D **€ 12.530 E € 13.270 F € 14.600**  
 cover: D1720L + D1720R **2x € 385 = 770 €**

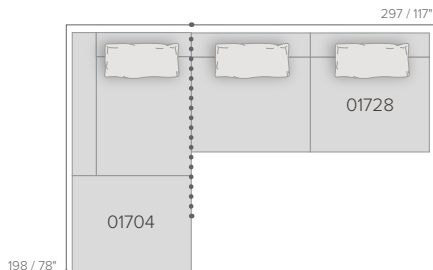

SET 2a  
 frame: 01704 + 01728  
 cushions: C01704W + C01728W  
 back cushions: 3x C0012W

total price: Cat. D **€ 12.825 E € 13.645 F € 15.020**  
 cover: D1905 **€ 655**

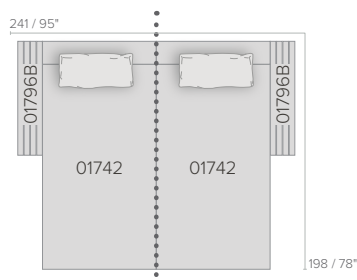

SET 3b  
 frame: 2x 01742 + 2x 01796B  
 cushions: 2x C01742W  
 back cushions: 2x C0012W

total price: Cat. D **€ 12.360 E € 13.000 F € 14.130**  
 price without borders: Cat. D **€ 11.240 E € 11.880 F € 13.010**  
 cover: D1721 **€ 655**

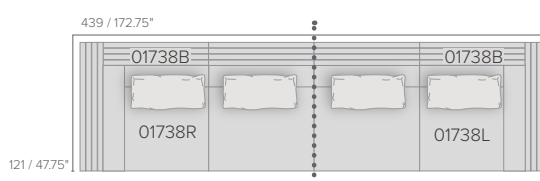

SET 4  
 frame: 01738R + 01738L + 2x 01738B  
 cushions: 2x C01738W  
 back cushions: 4x C0012W

total price: Cat. D **€ 18.050 E € 19.040 F € 20.660**  
 price without borders: Cat. D **€ 14.420 E € 15.410 F € 17.030**  
 cover: D1704 **€ 655**

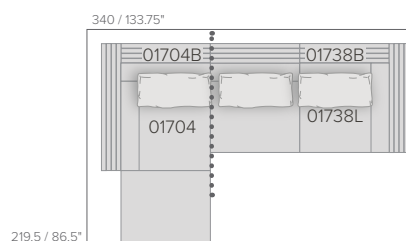

SET 5  
 frame: 01704 + 01738L + 01738B + 01704B  
 cushions: C01704W + C01738W  
 back cushions: 3x C0012W

total price: Cat. D **€ 16.680 E € 17.545 F € 19.020**  
 price without borders: Cat. D **€ 13.475 E € 14.340 F € 15.815**  
 cover: D1705 **€ 655**

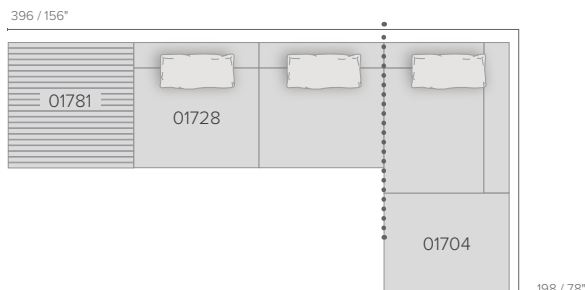

SET 6c  
 frame: 01781 + 01728 + 01704  
 cushions: C01728W + C01704W  
 back cushions: 3x C0012W

total price: Cat. D **€ 14.940 E € 15.760 F € 17.135**  
 price without table: Cat. D **€ 12.825 E € 13.645 F € 15.020**  
 cover: D1906 **€ 655**





Covers cover only the cushions, not the borders or tables. In case you order a high back cushion, please indicate the position on your set.

Les housses couvrent uniquement les coussins, pas les bords ou les tables. Si vous commandez un coussin de dossier élevé, veuillez indiquer sa position sur votre set.

De hoezen bedekken enkel de kussens, niet de boorden of tafels. Indien u een high back kussen bestelt, gelieve de positie ervan aan te duiden op uw set.

439.5 / 173"

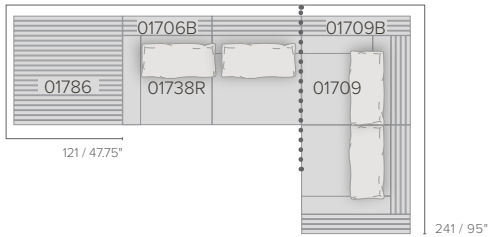

## SET 7

frame: 01738R + 01709 + 01786 + 01706B + 01709B  
 cushions: C01738W + C01709W  
 back cushions: 4x C0012W

total price: Cat. D € 21.990 E € 23.035 F € 24.755  
 price without borders & table: Cat. D € 15.060 E € 16.105 F € 17.825  
 cover: D1707 € 655

495 / 195"

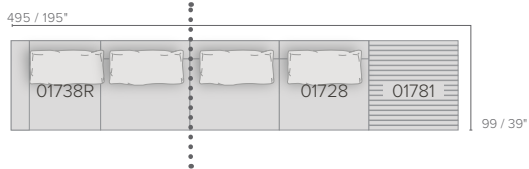

## SET 8

frame: 01738R + 01728 + 01781  
 cushions: C01738W + C01728W  
 back cushions: 4x C0012W

total price: Cat. D € 15.885 E € 16.830 F € 18.350  
 price without table: Cat. D € 13.770 E € 14.715 F € 16.235  
 cover: D1716 € 655

417 / 164.25"

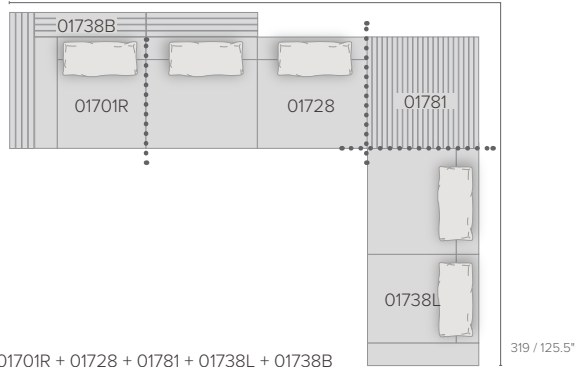

## SET 9a

frame: 01701R + 01728 + 01781 + 01738L + 01738B  
 cushions: C01701W + C01728W + C01738W  
 back cushions: 5x C0012W

total price: Cat. D € 21.780 E € 23.000 F € 24.975  
 price without borders & table: Cat. D € 17.850 E € 19.070 F € 21.045  
 cover: D1907 + D1738L € 495 + € 385 = € 880

516 / 203.25"

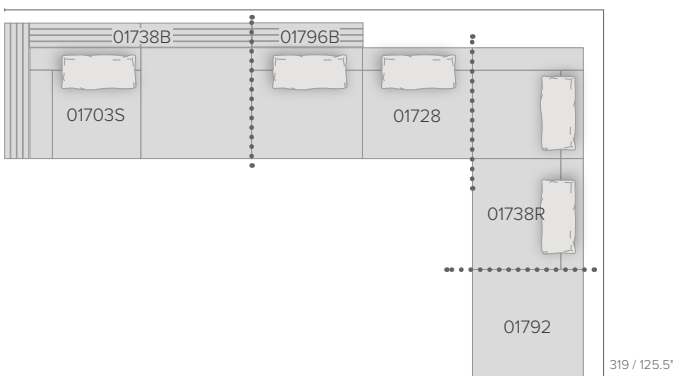

## SET 11a

frame: 01703S + 01728 + 01738R + 01792 + 01738B + 01796B  
 cushions: C01703SW + C01728W + C01738W + C01792W  
 back cushions: 5x C0012W

total price: Cat. D € 24.905 E € 26.315 F € 28.710  
 price without borders & table: Cat. D € 22.530 E € 23.940 F € 26.335  
 cover: D1909 € 1.150

396 / 156"

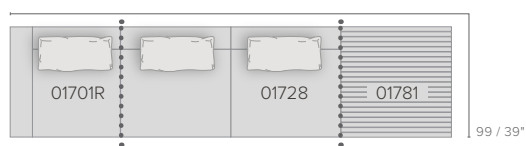

## SET 10a

frame: 01701R + 01728 + 01781  
 cushions: C01701W + C01728W  
 back cushions: 3x C0012W

total price: Cat. D € 12.755 E € 13.480 F € 14.645  
 price without table: Cat. D € 10.640 E € 11.365 F € 12.530  
 cover: D1908 € 495

516 / 203.25"

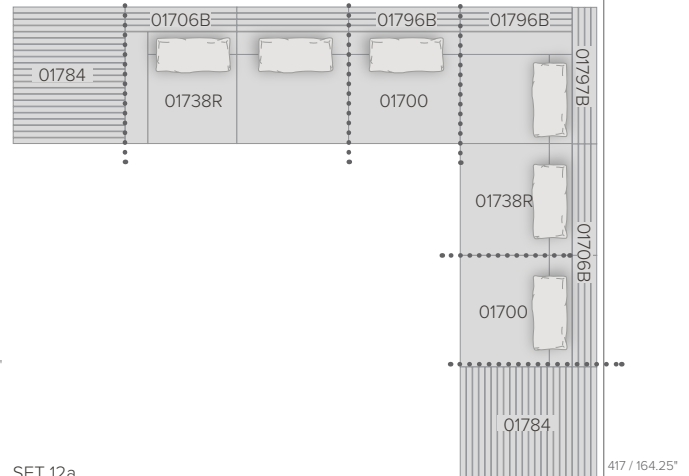

## SET 12a

frame: 2x 01784 + 2x 01738R + 2x 01700 + 2x 01796B + 2x 01706B + 01797B  
 cushions: 2x C01738W + 2x C01700W  
 back cushions: 5x C0012W

total price: Cat. D € 30.745 E € 32.185 F € 34.515  
 price without borders & table: Cat. D € 21.290 E € 22.730 F € 25.060  
 cover: D1910 € 985

# VIS À VIS SOFA SETS

PIERGIORGIO CAZZANIGA

Covers cover only the cushions, not the borders or tables. In case you order a high back cushion, please indicate the position on your set.

Les housses couvrent uniquement les coussins, pas les bords ou les tables. Si vous commandez un coussin de dossier élevé, veuillez indiquer sa position sur votre set.

De hoezen bedekken enkel de kussens, niet de boorden of tafels. Indien u een high back kussen bestelt, gelieve de positie ervan aan te duiden op uw set.

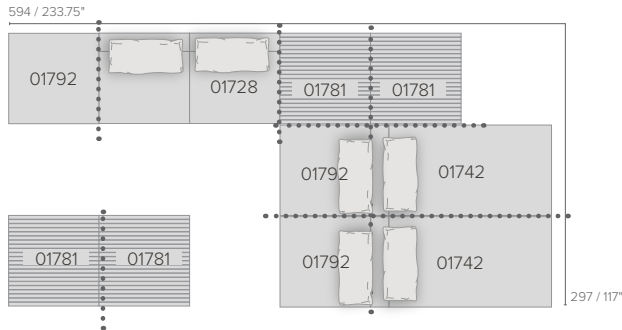

SET 13a

frame: 3x 01792 + 01728 + 2x 01742 + 4x 01781

cushions: 3x C01792W + C01728W + 2x C01742W

back cushions: 6x C0012W

total price: Cat. D € 34.435 E € 35.980 F € 38.550

price without tables: Cat. D € 25.975 E € 27.520 F € 30.090

cover: D1911 € 1.470

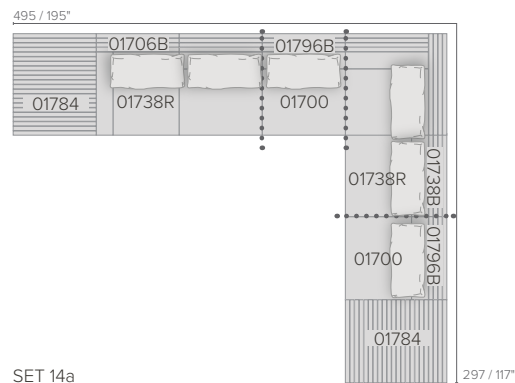

SET 14a

frame: 2x 01784 + 2x 01738R + 2x 01700 + 2x 01796B + 01706B + 01738B

cushions: 2x C01738W + 2x C01700W

back cushions: 6x C0012W

total price: Cat. D € 30.745 E € 32.185 F € 34.515

price without tables: Cat. D € 21.290 E € 22.730 F € 25.060

cover: D1913 € 980

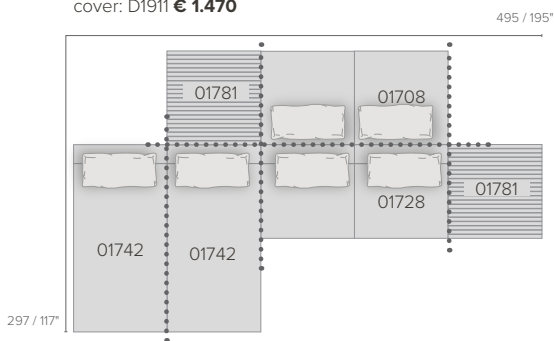

SET 15a

frame: 01708 + 2x 01742 + 01728 + 2x 01781

cushions: C01708W + C01728W + 2x C01742W

back cushions: 6x C0012W

total price: Cat. D € 27.400 E € 28.850 F € 31.210

price without tables: Cat. D € 23.170 E € 24.620 F € 26.980

cover: D1724 € 1.310

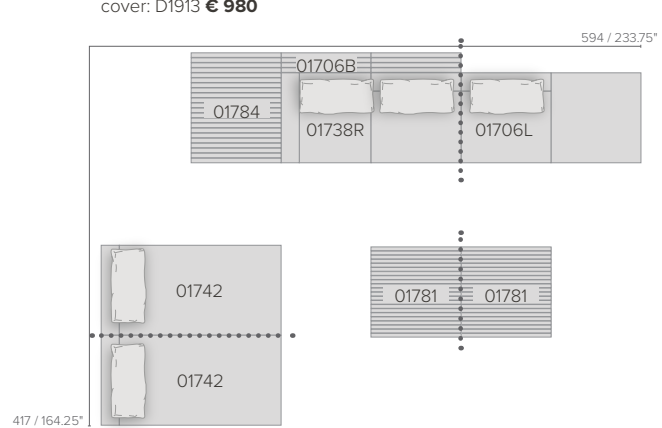

SET 16a

frame: 2x 01742 + 2x 01781 + 01784 + 01738R + 01706L + 01706B

cushions: 2x C01742W + C01738W + C01706W

back cushions: 5x C0012W

total price: Cat. D € 32.120 E € 33.575 F € 36.080

price without tables: Cat. D € 24.070 E € 25.525 F € 28.030

cover: D1914 + D1721 € 655 + € 655 = € 1.310

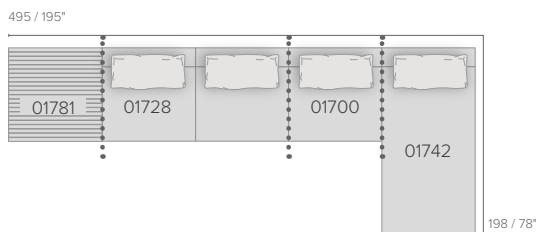

SET 17a

frame: 01781 + 01728 + 01700 + 01742

cushions: C01728W + C01700W + C01742W

back cushions: 4x C0012W

total price: Cat. D € 17.730 E € 18.725 F € 20.355

price without tables: Cat. D € 15.615 E € 16.610 F € 18.240

cover: D1915 € 820

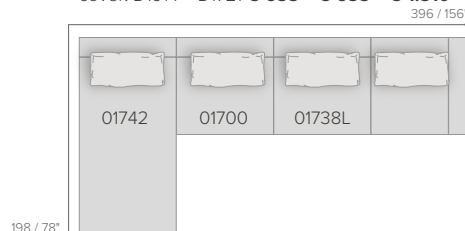

SET 18

frame: 01742 + 01700 + 01738L

cushions: C01742 + C01700W + C01738W

back cushions: 4x C0012W

total price: Cat. D € 16.265 E € 17.305 F € 19.035

cover: D1729 € 820



# UMBRELLAS

## PARASOL

☼ = solution-dyed / teinté dans la masse / in de massa geverfd

Eucalyptus wood  
Bois d'eucalyptus  
Eucalyptushout

Base not included  
Pied non inclus  
Voet niet inbegrepen

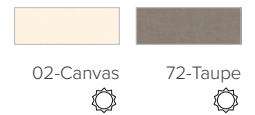

Eclipse (round)  
Eclipse (ronde)  
Eclipse (rond)



Cover  
Housse  
Hoes

€ 2.035 dia 350 cm  
Mast Ø 63 mm

UW315-02

UW315-72

D6003-X

€ 140

Eclipse (square)  
Eclipse (carré)  
Eclipse (vierkant)



Cover  
Housse  
Hoes

€ 2.165 300x300 cm  
€ 2.435 350x350 cm  
Mast Ø 63 mm

UW322-02  
UW323-02

UW322-72  
UW323-72

D6003-X  
D6004-X

€ 140  
€ 160



Granite base  
Base en granite  
Graniet voet

€ 435

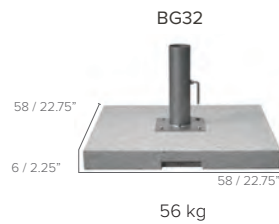

# LOW TABLES ALUMINIUM

TABLES BASSES - BIJZETTAFELS

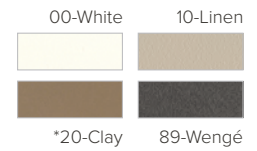

103

Powdercoated aluminium  
Aluminium laqué par poudrage  
Gepoedercoat aluminium

\* Only for Natal Alu X

Drops

D5026-00

40 / 15.75"



D5026-10



D5026-89



€ 500

Dia 40cm

Drops

D5027-00

60 / 23.5"



D5027-10



D5027-89



€ 900

Dia 60cm

Each packaging contains 3 tubes of 30, 40 and 50cm height. One of the 3 can be assembled as table leg, according to your liking.  
Chaque emballage contient 3 tubes d'une hauteur de 30, 40 et 50cm. Au choix un des 3 peut être monté comme pied de table.  
Elke verpakking bevat 3 tubes met een hoogte van 30, 40 en 50cm. Naar keuze kan één van de 3 gemonteerd worden als tafelpoot.

Natal Alu X high round  
Natal Alu X haute ronde  
Natal Alu X hoog rond

€ 575

06176-00



06176-10



06176-20



06176-89



Natal Alu X low 40x40cm  
Natal Alu X basse 40x40cm  
Natal Alu X laag 40x40cm

€ 645

06180-00

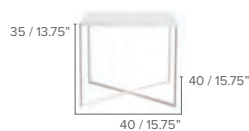

06180-10



06180-20



06180-89



Natal Alu X low 60x60cm  
Natal Alu X basse 60x60cm  
Natal Alu X laag 60x60cm

€ 1.050

06182-00



06182-10



06182-20



06182-89



Covers for tables see p.124-127  
Des housses pour les tables voir p.124-127  
Hoezen voor tafels zie p.124-127



# LOW TABLES MARE

TABLES BASSES - BIJZETTAFELS

NEW

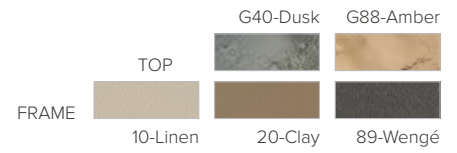

Mare Side Table

04560-10-Gx

32 / 12.5"



26 / 10.25"

04560-20-Gx



04560-89-Gx



€ 750

Dia 32 cm - H40/50cm

Mare Side Table

04580-10-Gx

48 / 19"



39 / 15.25"

04580-20-Gx



04580-89-Gx



€ 1.100

Dia 48 cm - H40/50cm

Each packaging contains 2 tubes of 40 and 50cm height. One of the 2 can be assembled as table leg, according to your liking.  
 Chaque emballage contient 2 tubes d'une hauteur de 40 et 50cm. Au choix un des 2 peut être monté comme pied de table.  
 Elke verpakking bevat 3 tubes met een hoogte van 40 en 50cm. Naar keuze kan één van de 2 gemonteerd worden als tafelpoot.

# LOW TABLES SEREN NEW

TABLES BASSES - BIJZETTAFELS

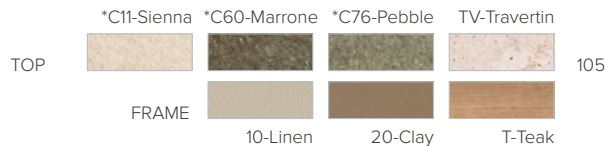

\*This colour may possibly show veins  
 \*Des veines peuvent éventuellement figurer sur cette couleur  
 \*Deze kleur kan mogelijk anders vertonen

Seren Side Table - 58x58 - H39cm

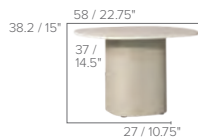

02882-x-Cx



02882-x-TV



02882-T-Cx



02882-T-TV

€ 1.350 Alu - Ceramic  
 € 1.880 Alu - Travertin

€ 1.450 Teak - Ceramic  
 € 1.980 Teak - Travertin

Seren Side Table - 58x58 - H46cm



02884-x-Cx



02884-x-TV



02884-T-Cx



02884-T-TV

€ 1.390 Alu - Ceramic  
 € 1.945 Alu - Travertin

€ 1.490 Teak - Ceramic  
 € 2.045 Teak - Travertin

Seren Coffee Table - 150x100 - H32cm

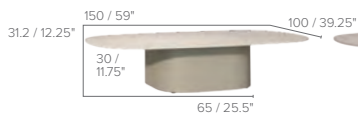

02886-x-Cx



02886-x-TV



02886-T-Cx



02886-T-TV

€ 2.800 Alu - Ceramic  
 € 5.165 Alu - Travertin

€ 2.950 Teak - Ceramic  
 € 5.315 Teak - Travertin



## TABLES BASSES - BIJZETTAFELS

Plantation teak from Java  
Teck de plantation de Java  
Plantageteak uit Java

 Dunes Side table  
Dunes Table d'appoint  
Dunes Bijzettafel



€ 2.275

 Dunes Coffee table  
Dunes Table de salon  
Dunes Koffietafel



€ 2.085

 **NEW** Dunes Side table - small  
Dunes Table d'appoint - petit  
Dunes Bijzettafel - klein



€ 3.000

 **NEW** Dunes Side table - Large  
Dunes Table d'appoint - grand  
Dunes Bijzettafel - groot



€ 4.000

 Dunes Low Dining table  
Dunes Table low dining  
Dunes Tafel low dining

Limited availability



€ 16.900

Roots

€ 1.590



C-table  
Table C  
C-tafel



€ 900

Pure - H48cm - H19"

02685



44 / 17.25"

44 / 17.25"

**NEW**

€ 1.150

Amanu - H50cm - H19.75"

The Dunes and Roots collections are defined by the elegant pattern of the wood grain. Chiseled out of Tribù's plantation-grown teak, every detail, every knot, every crack is proudly on display.

La forme de Dunes and Roots est déterminée par les sinuosités élégantes du grain du bois. Trouvant leur origine dans les plantations de teck de Tribù, chaque détail, chaque nœud, chaque fissure du bois sont superbement mis en valeur.

De Dunes and Roots collecties hebben hun vorm te danken aan de elegante houtnerven. De meubels zijn gemaakt van Tribù's plantage-teak, en dragen elk detail, elke knoop, elke scheur met trots.

# LOW TABLES TEAK

## TABLES BASSES - BIJZETTAFELS

The teak base is not made of solid teak  
La base en teck n'est pas en teck massif  
De basis in teak is niet gemaakt uit massief teak

Tairu

D8103-Lx



Lx-Table top: glazed lava stone  
Lx-Dessus de table: pierre de lave émaillée  
Lx-Tafelblad: geglazuurde lavasteen

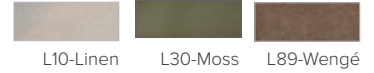

€ 1.240 Lavastone

Hexagon

Coffee Table

Side Table



€ 1.430 Lavastone

D5040-Lx

D5041-Lx

€ 1.340 Lavastone

Otto

Dia 48cm - H32cm

Dia 60cm - H32cm

Dia 90cm - H32cm

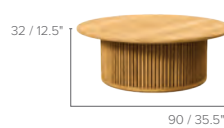

Table top: ceramic, travertine or teak  
Dessus de table: céramique, travertin ou teak  
Tafelblad: keramiek, travertin of teak

€ 1.495 Ceramic  
€ 1.495 Teak  
€ 2.100 Travertine

04281-Cx  
04281-T  
04281-TV

€ 1.695 Ceramic  
€ 1.695 Teak  
€ 2.600 Travertine

04283-Cx  
04283-T  
04283-TV

€ 2.145 Ceramic  
€ 2.145 Teak  
€ 4.600 Travertine

04284-Cx  
04284-T  
04284-TV

\*C15-Sabbia \*C80-Scisto  
\*\*TV-Travertine T-Teak

Dia 48cm - H45cm

Dia 60cm - H45cm



€ 1.595 Ceramic  
€ 1.595 Teak  
€ 2.200 Travertine

04280-Cx  
04280-T  
04280-TV

€ 1.795 Ceramic  
€ 1.795 Teak  
€ 2.600 Travertine

04282-Cx  
04282-T  
04282-TV

\* This colour may possibly show veins - Des veines peuvent éventuellement figurer sur cette couleur - Deze kleur kan mogelijk anders vertonen

\*\* This material is sensitive to stains - Ce matériau est sensible aux taches - Dit materiaal is vlekgevoelig

Covers for tables see p.124-127  
Des housses pour les tables voir p.124-127  
Hoezen voor tafels zie p.124-127



# ACCESSORIES

## ACCESSOIRES

Lanterns  
Lanternes  
Lantaarns

Lantern low

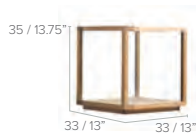

D5015

Lantern high

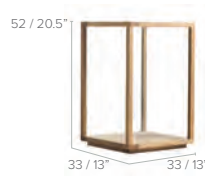

D5016

Lantern support



D5017

Teak frame



Chemically tempered glass  
Verre trempé chimiquement  
Chemisch versterkt glas

€ 390  
€ 450  
€ 460

Luna  
incl adapter



D09010-89

Powdercoated Aluminium  
89-Wengé



Handblown glass  
Verre soufflé à la bouche  
Handgeblazen glas

€ 995

Gobi

Small



D3020-x

Large



D3010-x

Recycled Acrylic  
Acrylique recyclé  
Gerecycleerd Acryl



10-Linen

30-Moss

€ 895  
€ 1.250

Gobi baskets dry very slowly, so we advise you not to leave this product out in the rain. We do not have any covers in our range.  
Comme les paniers Gobi sèchent très lentement, nous vous recommandons de ne pas les laisser sous la pluie. Notre assortiment ne comprend pas de protections.  
Gobi-manden drogen erg traag. We raden je aan om ze niet buiten in de regen te laten staan. We bieden geen covers aan voor dit product.

# LOFT RUGS

TAPIS EXTÉRIEURS - BUITENTAPIJTEN

PVC coated polyester  
Polyester enduit de PVC  
PVC gecoat polyester

\*in stock  
\*en stock  
\*op stock

\*\*on order - production time: 6 weeks  
\*\*sur commande - délai de production: 6 semaines  
\*\*op bestelling - productietijd: 6 weken

Rug Loft  
Tapis Loft  
Tapijt Loft

D2001-x



10-Linen 89-Wengé

€ 2.490	200x200cm**
€ 2.810	200x240cm**
€ 3.315	200x300cm**
€ 3.395	250x250cm**
€ 3.905	250x300cm**
€ 4.420	250x350cm**



# SHINDI RUGS

TAPIS EXTÉRIEURS - BUITENTAPIJTEN

PVC coated polyester  
Polyester enduit de PVC  
PVC gecoat polyester

3D weaving  
Tissage 3D  
3D weaving

Rug Shindi  
Tapis Shindi  
Tapijt Shindi

D2003-x

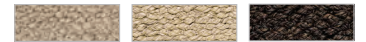

10-Linen 12-Hemp 89-Wengé

€ 2.935	200x200cm**
€ 3.450	200x250cm**
€ 3.955	200x300cm*
€ 5.425	200x350cm**
€ 5.550	200x450cm**
€ 5.550	300x300cm*
€ 7.530	300x400cm*



# CUSTOMISED RUGS

TAPIS SUR MESURE - MAATWERK TAPIJTEN

670 €/M<sup>2</sup> Loft  
790 €/M<sup>2</sup> Shindi

Maximum width 5m, unlimited length  
Largeur maximale 5m, longueur illimitée  
Maximale breedte 5m, lengte is onbeperkt



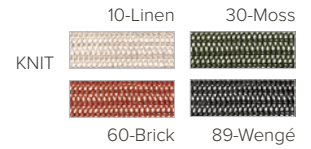

Removable knit in polyolefin rope  
Tricot amovible en corde polyoléfine  
Afnembaar breiwerk in polyolefine

LED lamp  
Lampe LED  
LED lamp

Monsieur Lebonnet



€ 1.040 Hanging 30cm  
€ 1.175 Hanging 40cm  
€ 1.655 Hanging 60cm

D080130H-xx

D080140H-xx

D080160H-xx

Madame Latoque



€ 1.040 Hanging 30cm  
€ 1.175 Hanging 40cm

D080230H-xx

D080240H-xx

Madame Cachet



€ 1.040 Hanging 30cm  
€ 1.175 Hanging 40cm  
€ 1.310 Hanging 50cm

D080330H-xx

D080340H-xx

D080350H-xx

Monsieur Ellipse



€ 1.175 Hanging 40cm

D080440H-xx

Removable knit in polyolefin rope  
Tricot amovible en corde polyoléfine  
Afnembaar breiwerk in polyolefine

€ 445 PR80130-x Knit Monsieur Lebonnet 30cm/11.75"  
€ 505 PR80140-x Knit Monsieur Lebonnet 40cm/15.75"  
€ 700 PR80160-x Knit Monsieur Lebonnet 60cm/23.5"

€ 445 PR80230-x Knit Madame Latoque 30cm/11.75"  
€ 505 PR80240-x Knit Madame Latoque 40cm/15.75"

€ 445 PR80330-x Knit Madame Cachet 30cm/11.75"  
€ 505 PR80340-x Knit Madame Cachet 40cm/15.75"  
€ 570 PR80350-x Knit Madame Cachet 50cm/19.75"

€ 445 PR80440-x Knit Monsieur Ellipse 40cm/15.75"

# MONSIEUR TRICOT STANDING

ONTWERPSTUDIO MAISON TRICOT



111

Removable knit in polyolefin rope  
Tricot amovible en corde polyoléfine  
Afnembaar breiwerk in polyolefine

LED lamp  
Lampe LED  
LED lamp

On/Off switch  
Bouton On/Off  
Aan/Uit schakelaar

Rechargeable battery with USB slot  
Batterie rechargeable avec port USB  
Oplaadbare batterij met USB poort

Ceiling hook included  
Crochet de plafond inclus  
Plafonddaak inbegrepen

Monsieur Lebonnet  
incl adapter



€ 1.040 Standing 30cm\*  
€ 1.175 Standing 40cm\*  
€ 1.655 Standing 60cm\*

D080130S-xx

D080140S-xx

D080160S-xx

Madame Latoque  
incl adapter



€ 1.040 Standing 30cm\*  
€ 1.175 Standing 40cm\*

D080230S-xx

D080240S-xx

Madame Cachet  
incl adapter



€ 1.040 Standing 30cm\*  
€ 1.175 Standing 40cm\*  
€ 1.310 Standing 50cm\*

D080330S-xx

D080340S-xx

D080350S-xx

Removable knit in polyolefin rope  
Tricot amovible en corde polyoléfine  
Afnembaar breiwerk in polyolefine

€ 445 PR80130-x Knit Monsieur Lebonnet 30cm/11.75"  
€ 505 PR80140-x Knit Monsieur Lebonnet 40cm/15.75"  
€ 700 PR80160-x Knit Monsieur Lebonnet 60cm/23.5"

€ 445 PR80230-x Knit Madame Latoque 30cm/11.75"  
€ 505 PR80240-x Knit Madame Latoque 40cm/15.75"

€ 445 PR80330-x Knit Madame Cachet 30cm/11.75"  
€ 505 PR80340-x Knit Madame Cachet 40cm/15.75"  
€ 570 PR80350-x Knit Madame Cachet 50cm/19.75"

€ 445 PR80440-x Knit Monsieur Ellipse 40cm/15.75"



# MONSIEUR TRICOT STANDING WIRED

ONTWERPSTUDIO MAISON TRICOT

NEW

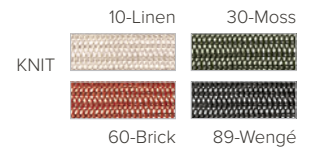

Removable knit in polyolefin rope  
Tricot amovible en corde polyoléfine  
Afneembaar breiwerk in polyolefine

LED lamp  
Lampe LED  
LED lamp

On/Off switch  
Bouton On/Off  
Aan/Uit schakelaar

## Monsieur Lebonnet



€ 990 Standing 30cm\*  
€ 1.125 Standing 40cm\*  
€ 1.605 Standing 60cm\*

D081130SW-xx

D081140SW-xx

D081160SW-xx

## Madame Latoque



€ 990 Standing 30cm\*  
€ 1.125 Standing 40cm\*

D081230SW-xx

D081240SW-xx

## Madame Cachet



€ 990 Standing 30cm\*  
€ 1.125 Standing 40cm\*  
€ 1.260 Standing 50cm\*

D081330SW-xx

D081340SW-xx

D081350SW-xx

Removable knit in polyolefin rope  
Tricot amovible en corde polyoléfine  
Afneembaar breiwerk in polyolefine

€ 445 PR80130-x Knit Monsieur Lebonnet 30cm/11.75"  
€ 505 PR80140-x Knit Monsieur Lebonnet 40cm/15.75"  
€ 700 PR80160-x Knit Monsieur Lebonnet 60cm/23.5"

€ 445 PR80230-x Knit Madame Latoque 30cm/11.75"  
€ 505 PR80240-x Knit Madame Latoque 40cm/15.75"

€ 445 PR80330-x Knit Madame Cachet 30cm/11.75"  
€ 505 PR80340-x Knit Madame Cachet 40cm/15.75"  
€ 570 PR80350-x Knit Madame Cachet 50cm/19.75"

€ 445 PR80440-x Knit Monsieur Ellipse 40cm/15.75"





# POUFS

Production time: 3 weeks  
 Délai de production: 3 semaines  
 Productietermijn: 3 weken



D € 550  
 E € 655  
 F € 775

Cover **D6021**  
 Housse € 165  
 Hoes



D € 675  
 E € 775  
 F € 895

Cover **D6022**  
 Housse € 185  
 Hoes

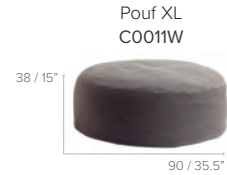

D € 910  
 E € 1.015  
 F € 1.140

Cover **D6023**  
 Housse € 290  
 Hoes

# NOMAD POUFS

Production time: 3 weeks  
 Délai de production: 3 semaines  
 Productietermijn: 3 weken



D € 1.040  
 E € 1.130  
 F € 1.300

Cover **D5032**  
 Housse € 185  
 Hoes



D € 1.530  
 E € 1.630  
 F € 1.875

Cover **D5033**  
 Housse € 290  
 Hoes



D € 2.485  
 E € 2.600  
 F € 2.990

Cover **D5034**  
 Housse € 355  
 Hoes

# MAI POUFS



12-Hemp



€ 2.795

Cover **D5582**  
 Housse € 290  
 Hoes



€ 1.945

Cover **D5584**  
 Housse € 210  
 Hoes

# DECO CUSHIONS

COUSSINS DE DÉCORATION - DECOKUSSENS



Scatter cushions  
Coussins de décoration  
Decokussen



Scatter cushions with piping  
Coussins de décoration avec passepoil  
Decokussen met bies



Box cushions  
Coussins plate-bande  
Decokussen met boord

	ART. NR.	DIMENSIONS	COLLECTION	cat D	cat E	cat F
SCATTER CUSHIONS	C0001-x	40x40cm		€ 120	€ 150	€ 180
	C0002-x	50x50cm		€ 155	€ 185	€ 210
	C0003-x	60x60cm		€ 190	€ 215	€ 240
	C0013-x	50x30cm	Tosca	€ 100	€ 120	€ 140
	C0016-x	75x75cm		€ 255	€ 305	€ 375
	C01712B-x	49x30cm	Vis à Vis lounge chair	€ 115	€ 130	€ 140
	C01713B-x	42,5x31,5cm	Vis à Vis rocking chair	€ 115	€ 130	€ 140
	C01718B-x	56x43cm	Vis à Vis armchair	€ 115	€ 130	€ 140
DECO + PIPING	C0001P-x-y	40x40cm		€ 155	€ 185	€ 210
	C0002P-x-y	50x50cm		€ 185	€ 220	€ 255
	C0003P-x-y	60x60cm		€ 220	€ 265	€ 315
	C0013P-x-y	50x30cm	Tosca	€ 140	€ 155	€ 185
	C01712BP-x-y	49x30cm	Vis à Vis lounge chair	€ 145	€ 170	€ 200
	C01713BP-x-y	42,5x31,5cm	Vis à Vis rocking chair	€ 140	€ 165	€ 195
	C01718BP-x-y	56x43cm	Vis à Vis armchair	€ 140	€ 165	€ 200
BOX CUSHIONS	C0004-x	55x35x8cm		€ 160	€ 185	€ 205
	C0012-x	63x45x15cm	Vis à Vis sofa	€ 345	€ 430	€ 480
	C06218B-x	40x25x13cm	Mood lumbar	€ 95	€ 115	€ 135
	C06218BH-x	38x38x13cm	Mood high back	€ 135	€ 170	€ 190
	C02300-x	68x45x15cm	Senja casual back	€ 350	€ 430	€ 480

x = Color of the fabric, determines the price category  
Couleur du tissu, détermine la catégorie de prix  
Kleur van de stof, bepaalt de prijscategorie

y = Piping color, only available in the following colors:  
Couleur de la passepoile, seulement disponible dans les couleurs suivantes:  
Kleur van de piping, enkel beschikbaar in volgende kleuren:

## y - Piping - Passepoil - Bies

01 Natté White	<b>NEW</b>	47 Natté Ochre	E103 Linen Mushroom	<b>NEW</b>
05 Natté Poivre	<b>NEW</b>	76 Granite	E107 Linen Dark Blue	<b>NEW</b>
42 Leaf		E81 Linen	E108 Linen Frost Blue	<b>NEW</b>
45 Natté Mist		E82 Linen White Sand	E111 Linen Verdant Grey	<b>NEW</b>

Head support lounger  
Repose tête chaise longue  
Hoofdsteun ligbed

**C0006W**



€ 245 cat D  
€ 265 cat E  
€ 295 cat F

Head support lounger round  
Repose tête chaise longue ronde  
Hoofdsteun ligbed rond

**C0005W**



€ 200 cat D  
€ 240 cat E  
€ 280 cat F

C0005 can be combined with Nodi, Kos, Forum and Ukiyo loungers.  
C0005 peut être combiné avec les chaises longues Nodi, Kos, Forum et Ukiyo.  
C0005 kan gecombineerd worden met de Nodi, Kos, Forum en Ukiyo ligbedden.

# FABRIC

TISSU - STOF

130 €/m cat D  
250 €/m cat E  
310 €/m cat F

Fabric per running meter only as part of an existing order and limited to a maximum of 5 meters  
Tissu par mètre linéaire uniquement dans le cadre d'une commande existante et limité à un maximum de 5 mètres  
Stof per meter enkel als onderdeel van een bestaande bestelling en beperkt tot een maximum van 5 meter



Maintenance products teak  
 Produits d'entretien teck  
 Onderhoudsproducten teak

Teak Super Cleaner  
 500 ml

€ 25

D9914



Teak Protector Grey Colour  
 500 ml

€ 30

D9912



Teak Sealer Natural  
 1000 ml

€ 160

D9959



Maintenance products stainless steel  
 Produits d'entretien inox  
 Onderhoudsproducten Inox

Stainless Steel Super Cleaner  
 (CB & EP)  
 250 ml

€ 40

D9918



Maintenance products aluminium & powdercoated stainless steel  
 Produits d'entretien aluminium & inox laqué par poudrage  
 Onderhoudsproducten aluminium & gepoederlakt aluminium

Coated aluminium & stainless steel Cleaner  
 500 ml

€ 35

D9952



Coated aluminium &  
 stainless steel Protector  
 500ml

€ 45

D9931



Coated aluminium & stainless steel Protector  
 500ml

€ 45

D9931



Maintenance products granite  
 Produits d'entretien granit  
 Onderhoudsproducten graniet

Granite Cleaner/Protector  
 500 ml

€ 80

D9961



Maintenance products fabrics + CTR, Elio, Mood, Regista & Tosca  
 Produits d'entretien tissus + CTR, Elio, Mood, Regista & Tosca  
 Onderhoudsproducten stoffen + CTR, Elio, Mood, Regista & Tosca

Textile Protector  
 500 ml

€ 45

D9924



Maintenance products synthetic material  
 Produits d'entretien matière synthétique  
 Onderhoudsproducten synthetisch materiaal  
 (Batyline®, Canax®, Sunscape, CTR, Elio, Mood, Nodi & Tosca weave)

Synthetics Super Cleaner D9922  
 500 ml

€ 35



Synthetics Protector D9921  
 500 ml

€ 30



Maintenance products ceramic and glazed lava stone  
 Produits d'entretien céramique et pierre de lave émaillée  
 Onderhoudsproducten keramiek en geglazuurde lavasteen

Ceramic, Lava Stone & Glass Cleaner D9938  
 500 ml

€ 35



Ceramic, Lava Stone & Glass Protector D9955  
 100 ml

€ 35



Maintenance products travertine

Travertine Conditioner D9967  
 250ml

€ 55

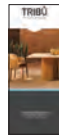

Maintenance products lightened concrete  
 Produits d'entretien béton allégé  
 Onderhoudsproducten verlicht beton

Lightened Concrete Conditioner D9962  
 500 ml

€ 90



Oil, Wax & Grease remover D9963  
 250 ml

€ 90



Sanding Disc HT013

€ 10



Lightened Concrete Care Set D9964  
 Kit soins pour béton allégé  
 Verlicht Beton Care set

€ 195

D9962 + D9963 + HT013 + Brush/Brosse/Borstel + Microfiber cloth/Chiffon en microfibre/Microvezeldoek

Correctors  
 Correcteurs  
 Correctors

D9933P	Paint pen aluminium white	8 ml	€ 30
D9943P	Paint pen aluminium wengé	8 ml	€ 30
D9955P	Paint pen aluminium linen	8 ml	€ 30
D9968P	Paint pen aluminium clay	8 ml	€ 30
D9956-xx	Aluminium corrector (00-white, 10-linen, 20-clay, 89-wengé)	12ml	€ 35

Microfiber cloth  
 Chiffon en microfibre  
 Microvezeldoek

D9935



€ 6

40x40cm









# LOW TABLES OVERVIEW

TABLES BASSES - LAGE TAFELS









## ROUND TABLES

Tables basses rondes – Lage ronde tafels

			Ø 32 Ø 12.5"	Ø 35 Ø 13.75"	Ø 40 Ø 15.75"	Ø 48 Ø 19"	Ø 50 Ø 19.75"	Ø 60 Ø 23.5"	Ø 80 Ø 31.5"	Ø 85 Ø 33.5"	Ø 90 Ø 35.5"	Ø 125 Ø 49.25"
AMANU		H28 - H11"									02684L	02686L
		H35 - H13.75"									02684M	02686M
		H42 - H16.5"									02684H	02686H
DROPS		H30 - H11.75"			D5026			D5027				
		H40 - H15.75"										
		H50 - H19.75"										
DUNES		H50 - H19.75"				D8300						
		H40 - H15.75"						D8302				
MARE		H40 - H15.75"	04560			04580						
		H50 - H19.75"										
NATAL ALU X		H45 - H17.75"		06176								
OTTO		H45 - H17.75"				04280		04282				
		H32 - H12.5"				04281		04283			04284	
T-TABLE		H35 - H13.75"							D2168		D2164	D2165

## SQUARE TABLES

Tables basses carrées – Lage vierkante tafels







			40x40 15.75x15.75"	42x45 16.5x17.75"	48x54 19x21.25"	58x58 22.75x22.75"	60x60 23.5x23.5"	66x66 26x26"	80x80 31.5"x31.5"	90x90 35.5"x35.5"	99x99 39x39"	102x102 40.25"	121x121 47.75x47.75"
KOS		H25 H9.75"		04090									
MOOD		H28 H11"						06282					
NATAL ALU X		H35 H13.75"	06180				06182						
SEREN		H39 H15.25"				02882							
		H46 H18"				02884							
TAO		H37 H14.5"							01682				
T-TABLE		H35 H13.75"								D2173			
TOSCA		H49,5 H19.5"			05381								
UKIYO		H36 14.25"										07586	
VIS A VIS		H18 H7"									01781		01786

# LOW TABLES OVERVIEW

## TABLES BASSES - LAGE TAFELS

### RECTANGULAR TABLES

Tables basses rectangulaires – Lage rechthoekige tafels

			120x66 47,25x26"	98x86 38.5x33.75"	121x99 47.75x39"	150x100 59x39.25"	159x44 62,5x17,25	160x70 63x27.5"	240x98 94.5x38.5"	298x98 117.25x38.5"
MOOD		H28 H11"	06284							
SEREN		H32 H12.5"				02886				
T-TABLE		H35 H13.75"							D2178	D2179
TOSCA		H31,5 H12.5"		05386						
UKIYO		H36 14.25"						07588		
VIS A VIS		H18 H7"			01784		01732			

### MISCELLANEOUS

Divers – Varia

			105x81cm 41.25x32"	140x107 55x42.25"	30x30 11.75x11.75"	35x40 13.75x15.75"	Ø 44 Ø 17.25"	Ø 50 Ø 19,75"	Ø 69 Ø 27.25"
AMANU C-TABLE TEAK		H50 H19.75"					02685		
PURE C-TABLE TEAK		H48 H19"				01285			
DUNES		H32 H12.5"	D8305	D8306					
ROOTS		H40 H15.75"			D8102				
TAIRU		H40 H15.75"			D8103				
HEXAGON		H31 H12.25"							D5040
		H49 H19.25"						D5041	











# DINING TABLES - OVERVIEW BY SIZE

TABLES À MANGER - EETTAfels







## BISTRO / BALCONY TABLES

Tables bistro/balcon - Bistro/Balcon tafels

		 2 SEATS	 2+2 SEATS
BRANCH		<b>07671</b> 80x80 31.5x31.5"	<b>07670</b> 90x90 35.5x35.5"
ILLUM			<b>06573</b> 100x100 39.5x39.5"
ILLUM TEAK			<b>06573-T</b> 100x100 39.5x39.5"
KOS			<b>04073</b> 98x98 38.5x38.5"
T-TABLE			<b>D2170</b> 90x90 35.5x35.5"
T-TABLE LOW DINING			<b>D2172</b> 90x90 35.5x35.5"
VIS A VIS			<b>01773</b> 99x99 39x39"

## ROUND TABLES

Tables rondes - Ronde tafels

		 3 SEATS	 4 SEATS	 6 SEATS	 7 SEATS
BRANCH		<b>07660</b> Ø80 Ø31.5"	<b>07662</b> Ø 125 cm Ø 49.25"		
OTTO DINING + LOW DINING				<b>04266</b> Ø 148 cm Ø58,25" <b>04267</b> Ø 148 cm Ø58,25"	
T-TABLE		<b>D2166</b> Ø80 Ø31.5"	<b>D2160</b> Ø90 Ø35.5" <b>D2162</b> Ø 125 cm Ø 49.25"		
T-TABLE LOW DINING		<b>D2167</b> Ø80 Ø31.5"	<b>D2161</b> Ø90 Ø35.5" <b>D2163</b> Ø 125 cm Ø 49.25"		
TAO				<b>01666</b> Ø 160 cm Ø 63"	<b>01668</b> Ø 180 cm Ø 71"

\* This guide is based on an average chair width of 55cm/21.75".

\* Ce guide est basé sur une largeur de chaise moyenne de 55cm/21.75".























\* Deze gids is gebaseerd op een gemiddelde stoelbreedte van 55cm/21.75".

# DINING TABLES - OVERVIEW BY SIZE

TABLES À MANGER - EETTAfels

## RECTANGULAR TABLES

Tables rectangulaires - Rechthoekige tafels

		 4 SEATS	 4+2 SEATS	 6+2 SEATS	 8+2 SEATS	 10+2 SEATS	 12+2 SEATS	 14+2 SEATS	 16+2 SEATS
AMANU					<b>02652</b> 290x98 114.25x38.5"	<b>02654</b> 350x98 137.75x38.5"			
BRANCH				<b>07652</b> 210x98 82.75x38.5"	<b>07654</b> 300x110 118x43.25"				
ILLUM			<b>06550</b> 152x100 60x39.5"	<b>06552xs</b> 212x71 83.5x28" <b>06552</b> 212x100 83.5x39.5"	<b>06554xs</b> 267x71 105x28" <b>06554</b> 267x100 105x39.5"				
ILLUM TEAK			<b>06550-T</b> 152x100 60x39.5"	<b>06552xs-T</b> 212x73 83.5x28.75" <b>06552-T</b> 212x100 83.5x39.5"	<b>06554-T</b> 267x100 105x39.5"				
KOS				<b>04052</b> 224x100 88x39.5"	<b>04053</b> 266x100 104.75x39.5" <b>04054</b> 308x110 121.25x39.5"				
LUCCA				<b>03252</b> 240x110 94.5x43.25"	<b>03254</b> 320x125 126x49.25"				
NOX					<b>02252</b> 264x99 104x39" <b>02254</b> 352x99 138.5x39"				
OTTO					<b>04254</b> 320x110 126x43.25" <b>04253</b> 290x110 114.25x43.25"				
SURO				<b>02752</b> 210x110 82.75x43.25"	<b>02753</b> 280x110 110.25x42.25"	<b>02754</b> 420x110 165.35x42.25"	<b>02755</b> 490x110 192.91x42.25"	<b>02756</b> 560x110 220.47x42.25"	<b>02757</b> 630x110 248.03x42.25"
T-TABLE		<b>D2183</b> 136x80 53.54x31.5"			<b>D2175</b> 240x98 94.5x38.5"	<b>D2176</b> 298x98 117.25x38.5"			
T-TABLE LOW DINING		<b>D2184</b> 136x80 53.54x31.5"			<b>D2177</b> 240x98 94.5x38.5"	<b>D2178</b> 298x98 117.25x38.5"			
TAO				<b>01670</b> 120x240cm 47.25x94.5"					
TOSCA				<b>05355</b> 240x98 94.5x38.5"	<b>05354</b> 298x98 117.25x38.5"				
UKIYO					<b>07553</b> 271x104 106.75x41"				
VIS A VIS					<b>01753</b> 300x99 118x39"	<b>01754</b> 400x99 157.5x39"	<b>01755</b> 500x99 197x39"	<b>01756</b> 600x99 236.25x39"	<b>01757</b> 700x99 275.5x39"









# DINING TABLES - OVERVIEW BY MATERIALS

TABLES À MANGER - EETTAfels

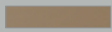
## CHOOSE YOUR FRAME







Choisissez votre cadre - Kies uw frame

	POWDERCOATED METAL MÉTAL LAQUÉ PAR POWDRAGE GEPOEDERLAKT METAAL				TEAK TECK TEAK	CONCRETE BÉTON BETON	
	00-White	10-Linen	20-Clay	89-Wengé		10-Linen	89-Wengé
							
AMANU					X		
BRANCH	X	X		X			
ILLUM	X	X		X	X		
KOS					X		
LUCCA		X	X	X			
NOX	X	X		X			
OTTO					X		
SURO			X		X		
TAO						X	X
TOSCA		X		X			
T-TABLE	X	X	X	X			
UKIYO					X		
VIS-À-VIS					X		

## CHOOSE YOUR TABLETOP

Choisissez votre dessus de table – Kies uw tafelblad

	ALUMINIUM			TEAK TECK TEAK	CERAMIC CÉRAMIQUE KERAMIEK						
	00-White	10-Linen	89-Wengé		10-Linen	11-Cienna	15-Sabbia	76-Pebble	80-Scisto	86-Pompei	89-Piombo
											
AMANU							X		X		
BRANCH	X	X	X	X							
ILLUM				X	X		X				X
ILLUM TEAK				X	X		X				X
KOS				X							
LUCCA						X		X		X	
NOX							X		X		
OTTO							X		X		
SURO				X							
TOSCA					X		X		X		X
T-TABLE				X	X		X		X		X
UKIYO				X	X		X		X		X
VIS-à-VIS				X							

	GLAZED LAVA STONE PIERRE DE LAVE ÉMAILLÉ GEËMAILLEERDE LAVASTEEN				CONCRETE BÉTON BETON		TRAVERTINE TRAVERTIN
	L10-Linen	L30-Moss	L70-Ocean	L89-Wengé	10-Linen	89-Wengé	TV-Travertine
							
NOX	X	X	X				
OTTO							X
T-TABLE	X	X		X			
TAO					X	X	

# COVERS FOR SOFA'S

Custom covers = 165€ per single seat and 330€ for meridienne and daybed modules. You will receive 1 cover, that is made exactly to the size of your modular sofa.

Housses sur mesure = 165€ par siège simple et 330€ pour les modules méridienne et daybed. Vous recevrez 1 housse, qui est faite exactement à la taille de votre canapé modulaire.

Covers op maat = 165€ per enkele zitplaats en 330€ voor meridienne en daybed modules. U ontvangt 1 hoes, die precies op maat van uw modulaire Sofa wordt gemaakt.

## NATAL ALU SOFA

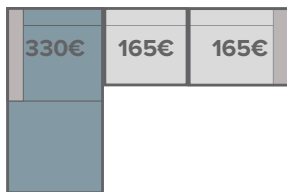

## NODI SOFA

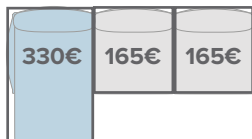

## PURE SOFA



## SENJA SOFA



## VIS À VIS SOFA

Covers cover only the cushions, not the borders or tables. In case you order a high back cushion, please indicate the position on your set.

Les housses couvrent uniquement les coussins, pas les bords ou les tables. Si vous commandez un coussin de dossier élevé, veuillez indiquer sa position sur votre set.

De hozen bedekken enkel de kussens, niet de boorden of tafels. Indien u een high back kussen bestelt, gelieve de positie ervan aan te duiden op uw set.





## HOUSES POUR TABLES À MANGER - HOEZEN VOOR EETTAFELS

Covers in PU-breathable material. Colour grey.  
Housses de protection en PU respirant. Couleur gris.  
Beschermhoezen in ademend PU. Kleur grijs.

Protection against dirt, not 100% waterproof  
Protection contre les saletés, n'est pas 100% imperméable à l'eau  
Vuilwerend, niet 100% waterdicht

COLLECTIONS	ART. NR.	TABLE DIMENSIONS	A	B	C
AMANU	D7290-100-A/B/C D7350-100-A/B/C	290 x 98cm   114.25 x 38.5" 350 x 98cm   137.75 x 38.5"	€ 585 € 645	€ 690 € 765	€ 830 € 915
BRANCH	D7080-A/C	Dia80cm   Dia31.5"	€ 315		€ 430
	D7125-A/C	Dia125cm   Dia49.25"	€ 405		€ 520
	D7080-80-A/B/C	80 x 80cm   31.5 x 31.5"	€ 315	€ 375	€ 480
	D7090-90-A/B/C	90 x 90cm   35.5 x 35.5"	€ 340	€ 410	€ 490
	D7210-98-A/B/C	210 x 98cm   82.75 x 38.5"	€ 475	€ 570	€ 760
	D7300-110-A/B/C	300 x 110cm   118 x 43.25"	€ 655	€ 785	€ 875
ILLUM	D7210-71-A/B/C	212 x 71cm   83.5 x 28"	€ 450	€ 545	€ 760
	D7210-73-A/B/C	212 x 73cm   83.5 x 28.75"	€ 450	€ 545	€ 760
	D7265-71-A/B/C	267 x 71cm   105 x 28"	€ 610	€ 725	€ 850
	D7100-100-A/B/C	100 x 100cm   39.5 x 39.5"	€ 375	€ 450	€ 495
	D7152-100-A/B/C	152 x 100cm   60 x 39.5"	€ 385	€ 465	€ 580
	D7210-98-A/B/C D7265-98-A/B/C	212 x 100cm   83.5 x 39.5" 267 x 100cm   105 x 39.5"	€ 475 € 630	€ 570 € 760	€ 760 € 850
ILLUM COUNTERHEIGHT	D6560-100-A/B/C	152 x 100cm   60 x 39.5"	€ 480	€ 565	€ 705
	D6564-71-A/B/C	212 x 71cm   83.5 x 28"	€ 480	€ 565	€ 705
KOS	D7100-100-A/B/C	98 x 98cm   38.5 x 38.5"	€ 375	€ 450	€ 495
	D7223-100-A/B/C	224 x 100cm   88 x 39.5"	€ 485	€ 590	€ 785
	D7265-100-A/B/C	266 x 100cm   104.75 x 39.5"	€ 630	€ 760	€ 860
	D7300-110-A/B/C	308 x 110cm   121.25 x 43.25"	€ 655	€ 785	€ 875
LUCCA	D7240-110-A/B/C	240 x 110cm   94.5 x 43.25"	€ 500	€ 600	€ 790
	D7320-125-A/B/C	320 x 125cm   126 x 49.25"	€ 660	€ 790	€ 880
NOX	D7265-100-A/B/C	264 x 99cm   104 x 39"	€ 630	€ 760	€ 860
	D7360-100-A/B/C	352 x 99cm   138.5 x 39"	€ 725	€ 875	€ 1.100
OTTO DINING	D7148-A/C	Dia 148cm   58.25"	€ 395		€ 500
	D7290-110-A/B/C	290 x 110cm   114.25 x 43.25"	€ 585	€ 690	€ 830
	D7320-110-A/B/C	320 x 110cm   126 x 43.25"	€ 675	€ 805	€ 895
SURO	D7210-110-A/B/C	210 x 110cm   82.75 x 43.25"	€ 475	€ 570	€ 760
	D7280-110-A/B/C	280 x 110cm   110.25 x 43.25"	€ 650	€ 755	€ 855
	D7420-110-A/B/C	420 x 110cm   165.25 x 43.25"	€ 730	€ 880	€ 1.105
	D7490-110-A/B/C	490 x 110cm   193 x 43.25"	€ 915	€ 1.100	€ 1.465
	D7560-110-A/B/C	560 x 110cm   220.5 x 43.25"	€ 1.200	€ 1.445	€ 1.740
	D7630-110-A/B/C	630 x 110cm   248 x 43.25"	€ 1.320	€ 1.465	€ 1.860
T-TABLE	D7080-75-A/C	Dia80cm   Dia31.5"	€ 315		€ 430
	D7090-75-A/C	Dia90cm   Dia35.5"	€ 340		€ 360
	D7125-75-A/C	Dia125cm   Dia49.25"	€ 355		€ 465
	D7090-90-A/B/C	90 x 90cm   35.5 x 35.5"	€ 340	€ 410	€ 490
	D7240-98-A/B/C	240 x 98cm   94.5 x 38.5"	€ 500	€ 600	€ 796
	D7298-98-A/B/C	298 x 98cm   117.25 x 38.5"	€ 655	€ 785	€ 875
	D7136-80-A/B/C	136 x 80cm   53.54 x 31.5"	€ 390	€ 400	€ 480
TAO	D1666-75-A/C	Dia160cm   Dia63"	€ 545		€ 565
	D1668-75-A/C	Dia180cm   Dia71"	€ 565		€ 595
	D1670-75-A/B/C	120x240cm   47.25x-94.5"	€ 500	€ 600	€ 796
TOSCA	D7240-98-A/B/C	240 x 98cm   94.5 x 38.5"	€ 500	€ 600	€ 796
	D7300-98-A/B/C	298 x 98cm   117.25 x 38.5"	€ 655	€ 785	€ 875
UKIYO	D7271-104-A/B/C	271 x 104cm   106.69 x 40.94"	€ 535	€ 635	€ 760
VIS-À-VIS	D7099-99-A/B/C	99 x 99cm   39 x 39"	€ 350	€ 415	€ 480
	D7300-99-A/B/C	300 x 99cm   118 x 39"	€ 655	€ 785	€ 875
	D7400-99-A/B/C	400 x 99cm   157.5 x 39"	€ 725	€ 875	€ 1.100
	D7500-99-A/B/C	500 x 99cm   197 x 39"	€ 915	€ 1.100	€ 1.465
	D7600-99-A/B/C	600 x 99cm   236.25 x 39"	€ 1.220	€ 1.465	€ 1.760
	D7700-99-A/B/C	700 x 99cm   275.5 x 39"	€ 1.470	€ 1.760	€ 1.890

**A**

**A:** Cover for table only.  
Housse pour la table uniquement.  
Hoes voor enkel tafel.

**B:** Cover for table with chairs. Please specify the type of chairs when ordering.  
Housse pour table avec chaises. Veuillez spécifier quelles chaises lorsque vous passez à la commande.  
**B:** Hoes voor tafel met stoelen. Gelieve het type stoel te vermelden bij uw order.

# COVERS FOR LOW DINING TABLES

HOUSES POUR TABLES À MANGER BASSES - HOEZEN VOOR LAGE EETTAfels

COLLECTIONS	ART. NR.	TABLE DIMENSIONS	A	B	C
OTTO LOW DINING - H64cm	D7148-64-A/C	Dia 148cm   H64cm	€ 395		€ 500
T-TABLE LOW DINING - H64cm	D7080-64-A/C	Dia80cm   Dia31.5"	€ 315		€ 380
	D7090-64-A/C	Dia90cm   Dia35.5"	€ 340		€ 410
	D7125-64-A/C	Dia125cm   Dia49.25"	€ 315		€ 480
	D7090-90-64-A/B/C	90 x 90cm   35.5 x 35.5"	€ 340	€ 410	€ 490
	D7240-98-64-A/B/C	240 x 98cm   94.5 x 38.5"	€ 500	€ 600	€ 796
	D7298-98-64-A/B/C	298 x 98cm   117.25 x 38.5"	€ 655	€ 785	€ 875
T-TABLE LOW DINING - H67cm	D7136-80-64-A/B/C	136x80cm   53.54 x 31.5"	€ 390	€ 400	€ 480
	D7080-67-A/C	Dia80cm   Dia31.5"	€ 315		€ 430
	D7090-67-A/C	Dia90cm   Dia35.5"	€ 340		€ 450
	D7125-67-A/C	Dia125cm   Dia49.25"	€ 345		€ 465
	D7090-90-67-A/B/C	90 x 90cm   35.5 x 35.5"	€ 340	€ 410	€ 490
	D7240-98-67-A/B/C	240 x 98cm   94.5 x 38.5"	€ 500	€ 600	€ 796
TOSCA LOW DINING - H67cm	D7298-98-67-A/B/C	298 x 98cm   117.25 x 38.5"	€ 655	€ 785	€ 875
	D7240-98-67-A/B/C	240x98x67cm   94.5 x 38.5"	€ 500	€ 600	€ 796



**C:** Cover for table with chairs at the side and head of the table. Please specify the type of chairs when ordering.

**C:** Housse pour table avec chaises sur les côtés et à la tête de la table. Veuillez spécifier quelles chaises lorsque vous passez à la commande.

**C:** Hoes voor tafel met stoelen aan de zijkant en op de koppen. Gelieve het type stoel te vermelden bij uw order.





# COVERS FOR LOW TABLES

## HOUSSES POUR TABLES BASSES - HOEZEN VOOR LAGE TAFELS

Covers in PU-breathable material. Colour grey.

Housses de protection en PU respirant. Couleur gris.

Beschermhoezen in ademend PU. Kleur grijs.

Protection against dirt, not 100% waterproof

Protection contre les saletés, n'est pas 100% imperméable à l'eau

Vuilwerend, niet 100% waterdicht

COLLECTIONS	ART. NR.	ART. NR. COVER	TABLE DIMENSIONS	A
AMANU	02684L	D2684L	Dia 90 x H28cm   Dia 35.5 x 11"	€ 220
	02684M	D2684M	Dia 90 x H35cm   Dia 35.5 x 13.75"	€ 250
	02684H	D2684H	Dia 90 x H42cm   Dia 35.5 x 16.5"	€ 275
	02686L	D2686L	Dia 125 x H28cm   Dia 49.25 x 11"	€ 290
	02686M	D2686M	Dia 125 x H35cm   Dia 49.25 x 13.75"	€ 330
	02686H	D2686H	Dia 125 x H42cm   Dia 49.25 x 16.5"	€ 355
	02688L	D2688L	155 x 58 x H28cm   61 x 22.75 x 11"	€ 230
	02688M	D2688M	155 x 58 x H35cm   61 x 22.75 x 13.75"	€ 245
	02688H	D2688H	155 x 58 x H42cm   61 x 22.75 x 16.5"	€ 260
	02685	D2685	Dia 44 x H50cm   Dia 17.25 x H19.75"	€ 155
DROPS	D5026	D5030	Dia40 x H 30cm   Dia15.75 x H12.25"	€ 160
	D5027	D5031	Dia60 x H 30cm   Dia23.5 x H12.25"	€ 175
DUNES	D8300	D8301	Dia48 x H50cm   Dia19 x H19.75"	€ 155
	D8302	D8303	Dia60 x H40cm   Dia23,5 x H15.75"	€ 145
HEXAGON	D5040	D5042	Dia69xH31cm   Dia27.25 x H12.25"	€ 160
	D5041	D5043	Dia50xH49cm   Dia19.75 x H19.25"	€ 160
KOS	04090	D6095	42 x 45 x H25cm   16.5 x 17.75 x H10"	€ 115
MARE	04560 - H40	D4560	Dia 32 x H40cm   12.5 x H15.75"	€ 160
	04560 - H50	D4561	Dia 32 x H50cm   12.5 x H19.75"	€ 170
	04580 - H40	D4580	Dia 48 x H40cm   19 x H15.75"	€ 175
	04580 - H50	D4581	Dia 48 x H50cm   19 x H19.75"	€ 185
MOOD	06282	D6096	66 x 66 x H28cm   26x26xH11"	€ 125
	06284	D6108	120 x 66 x H28cm   47.25x26xH11"	€ 185
NATAL ALU	06176	D6176	Dia35 x H45cm   Dia13.75 x H17.75"	€ 145
	06180	D6180	40 x 40 x H35cm   15.75 x 15.75 x H13.75"	€ 165
	06182	D6182	60 x 60 x H35cm   23.5 x 23.5 x H13.75"	€ 180
OTTO	04280	D4280	Dia 48cm x H45cm   Dia 19 x H17.75"	€ 155
	04281	D4281	Dia 48cm x H32cm   Dia 19 x H12.6"	€ 150
	04282	D4282	Dia 60cm x H45cm   Dia 23.5 x 17.75"	€ 165
	04283	D4283	Dia 60cm x H32cm   Dia 12.5 x 12.6"	€ 160
	04284	D4284	Dia 90cm x H32cm   Dia 35.5 x 12.6"	€ 255
PURE	01285	D6123	42 x 37 x H48cm   16.53 x 14.56 x 18.89"	€ 125
ROOTS	D8102	D8101S - Standing D8101L - Lying	30 x 30 x H40cm   11.75 x 11.75 x H15.75"	€ 125 € 125
SEREN	02882	D2882	58 x 58 x H39cm   22.75 x 22.75 x H15.25"	€ 190
	02884	D2884	58 x 58 x H46cm   22.75 x 22.75 x H18"	€ 210
	02886	D2886	150 x 100 x H32cm   59 x 39.25 x H12.5"	€ 380
TAIRU	D8103	D8101S	30 x 30 x H40cm   11.75 x 11.75 x H15.75"	€ 125
T-TABLE	D2168	D7080	Dia80 x H35cm   Dia31.5 x H13.75"	€ 225
	D2164	D7090	Dia90 x H35cm   Dia35.5 x H13.75"	€ 250
	D2165	D7125	Dia125 x H35cm   Dia49.25 x H13.75"	€ 330
	D2174	D7090-90-35	90 x 90 x H35cm   35.5 x 35.5 x H13.75"	€ 255
	D2179	D7240-98-35	240 x 98 x H35cm   94.5 x 38.5 x H13.75"	€ 425
	D2180	D7298-98-35	298 x 98 x H35cm   117.25 x 38.5 x H13.75"	€ 560
	D2185	D7136-80-35	136 x 80 x H35cm   53.54 x H31.5 x H13.75"	€ 360
TAO	01682	D1682	Dia80 x H37cm   Dia31.5 x H14.5"	€ 355
TOSCA	05381	D5381	54 x 48 x H49,5cm   21.25 x 19 x H19,5"	€ 140
	05386	D5386	98 x 86 x H31,5cm   38.5 x 33.75 x H12,5"	€ 230
UKIYO	07586	D7586	102 x 102 x 36cm   40.16 x 40.16 x H14.17"	€ 345
	07588	D7588	160 x 70 x 36 cm   63 x 27.56 x H14.17"	€ 245
VIS-À-VIS	01781	D1781	99 x 99 x H18cm   39 x 39 x H7"	€ 140
	01784	D1784	121 x 99 x H18cm   47.75 x 39 x H7"	€ 165
	01786	D1786	121 x 121 x H18cm   47.75 x 47.75 x H7"	€ 220









# TECHNICAL STANDARDS

## NORMES TECHNIQUES - TECHNISCHE NORMEN

A perfect quality is the cornerstone of Tribù's company philosophy. This is guaranteed by a careful selection of the most durable materials, a long term cooperation with industrial partners, each an expert in their field, and a rigorous testing of our models in compliance to both EU and USA standards.

### BIFMA X5- RANGE

BIFMA (Business and Institutional Furniture Manufacturers Association) is an American standard that sets the acceptance levels and test parameters for evaluating the safety, durability and structural adequacy of contract furniture.

### EN 581-1:2006

A EU standard that specifies the general safety requirements for seating and tables.

### EN 1728:2012

A EU standard that specifies the mechanical requirements (strength and stability) and test methods for furniture seating.

### EN 1022:2005 6

A EU standard that measures the stability of domestic furniture.

### CPSD-HL-01012-MTHD

Measures the effect of extreme temperature change (24hrs at -17°C/0 °F and 48°C/120°F).

### CPSD-HL-01063-MTHD

Measures the moisture content of wood, which should be between 8 and 12%.

### CPSD-HL-01010-MTHD/ASTM B117-11

Measures the resistance to corrosion of metal parts.

### AATCC 16

Measures the colourfastness to light.

### AATCC106

Measures the colourfastness to sea water.

### AATCC162

Measures the colourfastness to chlorinated pool water.

### ASTM B117-11

Tests the corrosion resistance of coated metals in a controlled atmosphere.

La philosophie de l'entreprise Tribù repose sur une qualité parfaite que nous garantissons en sélectionnant soigneusement les matériaux les plus résistants et en collaborant avec des partenaires industriels fixes, chacun expert dans son domaine. En outre, nous soumettons nos modèles à des tests rigoureux en conformité aux normes de l'UE et USA.

### BIFMA X5- RANGE

BIFMA (Business and Institutional Furniture Manufacturers Association) est une norme américaine qui fixe les niveaux d'acceptation et les paramètres d'essai test pour évaluer la sécurité, la durabilité et l'adéquation structurelle de meubles pour le secteur du contrat.

### EN 581-1:2006

Une norme européenne qui spécifie les exigences générales de sécurité des sièges et des tables.

### EN 1728:2012

Une norme européenne qui spécifie les exigences mécaniques (résistance et stabilité) et méthodes d'essai pour les sièges.

### EN 1022:2005 6

Une norme européenne qui mesure la stabilité du mobilier domestique .

### CPSD-HL-01012-MTHD

Mesure l'effet des températures extrêmes (24hrs à -17°C et 48°C).

### CPSD-HL-01063-MTHD

Mesure la teneur en humidité du bois. Ceci devrait être compris entre 8 et 12 %.

### CPSD-HL-01010-MTHD/ASTM B117-11

Mesure la résistance à la corrosion des pièces métalliques.

### AATCC 16

Mesure la solidité des couleurs à la lumière.

### AATCC106

Mesure la solidité des couleurs à l'eau de mer.

### AATCC162

Mesure la solidité des couleurs à l'eau de piscine chlorée.

### ASTM B117-11

Teste la résistance à la corrosion des métaux laqués dans une atmosphère contrôlée.

Een perfecte kwaliteit is de hoeksteen van Tribù's bedrijfsfilosofie. Deze kwaliteit wordt gegarandeerd door een zorgvuldige selectie van de meest duurzame materialen, een lange termijn samenwerking met industriële partners, elk expert in hun gebied, en het uitgebreid testen van onze modellen om te voldoen aan zowel EU als VS-normen.

### BIFMA X5- RANGE

BIFMA (Business and Institutional Furniture Manufacturers Association) is een Amerikaanse norm die de aanvaardingniveaus en testparameters vastlegt voor het evalueren van de veiligheid, duurzaamheid en structurele adequaatheid van projectmeubilair.

### EN 581-1:2006

Een EU norm die de algemene veiligheidsvereisten vastlegt voor zitmeubelen en tafels.

### EN 1728:2012

Een EU norm die de mechanische vereisten (sterkte en stabiliteit) en

testmethodes vastlegt voor zitmeubelen.

### EN 1022:2005 6

Een EU norm die de stabiliteit meet van meubelen voor huishoudelijk gebruik.

### CPSD-HL-01012-MTHD

Meet het effect van extreme temperaturen (24u aan -17°C en 48°C).

### CPSD-HL-01063-MTHD

Meet het vochtgehalte van hout dat tussen de 8 en 12% moet zijn.

### CPSD-HL-01010-MTHD/ASTM B117-11

Meet de corrosiebestendigheid van metalen onderdelen.

### AATCC 16

Meet de kleurvastheid bij blootstelling aan licht.

### AATCC106

Meet de kleurvastheid bij blootstelling aan zeewater.

### AATCC162

Meet de kleurvastheid bij blootstelling aan zwembadwater met chloor.

### ASTM B117-11

Test de corrosie van gecoate metalen in een gecontroleerde atmosfeer.

# TECHNICAL STANDARDS CHAIRS

NORMES TECHNIQUES - TECHNISCHE NORMEN

---

AMANU (p. 8)  
loung chair

ANSI/BIFMA X5.1-2017



BRANCH (p. 12)  
side chair, armchair

ANSI/BIFMA X5.1-2011

EN1022:2005 6  
EN581-1:2006 5  
EN 1728:2012

ASTM B117-11 (Mod.)

CPSD-HL-01010-MTHD  
CPSD-HL-01012-MTHD



CTR (p. 16)  
armchair

ANSI/BIFMA X5.1-2011

EN1022:2005 6  
EN581-1:2006 5  
EN 1728:2012

ASTM B117-11 (Mod.)

CPSD-HL-01010-MTHD  
CPSD-HL-01012-MTHD



ILLUM (p. 28)  
armchair

ANSI/BIFMA X5.1-2011

EN1022:2005 6  
EN581-1:2006 5  
EN 1728:2012

ASTM B117-11 (Mod.)

CPSD-HL-01010-MTHD  
CPSD-HL-01012-MTHD



KOS (p. 32)  
armchair, lounge chair

ANSI/BIFMA X5.1-2011

EN1022:2005 6  
EN581-1:2006 5  
EN 1728:2012

CPSD-HL-01063-MTHD  
CPSD-HL-01012-MTHD



MOOD (p. 36-37)  
armchair, lounge chair, bar chair

ANSI/BIFMA X5.1-2011

EN1022:2005 6  
EN581-1:2006 5  
EN 1728:2012

ASTM B117-11 (Mod.)

CPSD-HL-01010-MTHD  
CPSD-HL-01012-MTHD  
CPSD-HL-01063-MTHD

AATCC 16  
AATCC 106  
AATCC 162





NODI (p. 49)  
armchair, lounge chair

ANSI/BIFMA X5.1-2011

EN1022:2005 6  
EN581-1:2006 5  
EN 1728:2012

ASTM B117-11 (Mod.)

CPSD-HL-01010-MTHD  
CPSD-HL-01012-MTHD



NOMAD (p. 58)  
armchair, lounge chair

BIFMA X5.1-2017

EN581-1:2017  
EN581-2:2015/AC2016

ANSI/BIFMA X5.1-2017



SENJA WITH ALU LEGS (p. 70)  
armchair, lounge chair

BIFMA X5.4-2020



TOSCA (p. 89)  
armchair

ANSI/BIFMA X5.1-2011

EN1022:2005 6  
EN581-1:2006 5  
EN 1728:2012

ASTM B117-11 (Mod.)

CPSD-HL-01010-MTHD  
CPSD-HL-01012-MTHD

AATCC 16  
AATCC 106  
AATCC 162



BRANCH (p. 12)  
lounger

ANSI/BIFMA X5.4 - 2012    ASTM B117-11 (Mod.)

CPSD-HL-01010-MTHD  
CPSD-HL-01012-MTHD



FORUM (p. 27)  
lounger

ANSI/BIFMA X5.4 - 2012

EN 581-1:2006 5.1  
EN 581-1:2006 5.2  
EN 581-1:2006 5.3.1  
EN 581-1:2006 5.3.3  
EN 581-1:2006 6.2.1  
  
EN581-2:2009 Annex A  
EN581-2:2009 B.2.1.3  
EN581-2:2009 B.2.1.7  
EN581-2:2009 B.3.1.1  
EN581-2:2009 B.3.1.2

EN1728:2000 6.2.1  
EN1728:2000 6.2.2  
EN1728:2000 6.3  
EN1728:2000 6.7  
EN1728:2000 6.9  
EN1728:2000 6.12  
EN1728:2000 6.13  
EN1728:2000 6.15  
  
EN1022:2005 6.2  
EN1022:2005 6.4  
EN1022:2005 6.6  
EN1022:2005 7.5



KOS (p. 33)  
lounger

ANSI/BIFMA X5.4 - 2012

CPSD-HL-01063-MTHD  
CPSD-HL-01012-MTHD



SENJA (p. 71)  
lounger

ANSI/BIFMA X5.4 - 2012



TOSCA (p. 92)  
lounger

ANSI/BIFMA X5.4 - 2012    ASTM B117-11 (Mod.)

CPSD-HL-01010-MTHD  
CPSD-HL-01012-MTHD

AATCC 16  
AATCC 106  
AATCC 162











# PRICING CUSHIONS

TARIFICATION DES COUSSINS - PRIJZENSYSTEEM KUSSENS

## CATEGORIES

The price of the cushions depends on the type of fabric.

All of our cushions are made to order and can therefore not be cancelled after 24 h. The delivery time is 4 weeks.

	CATEGORY D	CATEGORY E	CATEGORY F
FABRIC	Sunbrella®	Basc Duas Knit Linen Natural Nesso Rustic Weave Yuttu	Naram Siva Sujàn

## CATÉGORIES

Le prix des coussins dépend du type de tissu.

Tous nos coussins sont fabriqués sur commande et ne peuvent plus être annulés après 24h. Le délai de livraison est de 4 semaines.

	CATÉGORIE D	CATÉGORIE E	CATÉGORIE F
TISSU	Sunbrella®	Basc Duas Knit Linen Natural Nesso Rustic Weave Yuttu	Naram Siva Sujàn

## CATEGORIEËN

De prijzen van de kussens worden bepaald door het type stof.

Al onze kussens worden op bestelling gemaakt en kunnen hierdoor na 24u niet meer geannuleerd worden. Als levertermijn moet u 4 weken voorzien.

	CATEGORIE D	CATEGORIE E	CATEGORIE F
STOF	Sunbrella®	Basc Duas Knit Linen Natural Nesso Rustic Weave Yuttu	Naram Siva Sujàn

# FIRE RETARDANT CUSHIONS

DES COUSSINS FEU RETARDANT - BRANDVERTRAGENDE KUSSENS

---

For projects, Tribù is able to offer fire retardant cushions (foam and fabric).

We are happy to work with you on your project and find the best solution.  
Please do not hesitate to contact our contract department ([teamcontract@tribu.com](mailto:teamcontract@tribu.com)) for a tailored solution.

---

Pour les projets, Tribù est capable d'offrir des coussins (mousse et tissu) feu retardant.

Nous sommes heureux de travailler avec vous sur votre projet et de rechercher la meilleure solution.  
Contactez notre Service Contractuel ([teamcontract@tribu.com](mailto:teamcontract@tribu.com)) pour une solution sur mesure.

---

Voor projecten kan Tribù brandvertragend kussens (schuim en stof) aanbieden.

Wij werken graag samen met u aan uw project en zoeken naar de beste oplossing.  
Contacteer onze contractafdeling ([teamcontract@tribu.com](mailto:teamcontract@tribu.com)) voor een oplossing op maat.



SUNBRELLA®



01 - Natté White



03 - Oyster



NEW

04 - Natté Sandstone



NEW

05 - Natté Poivre



06 - Natté Dune



07 - Papyrus\*

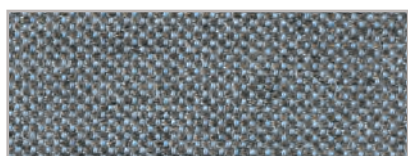

08 - Natté Carbon Sky

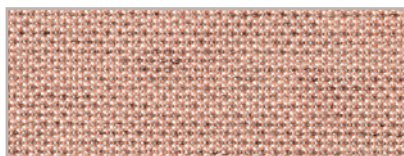

11 - Blush

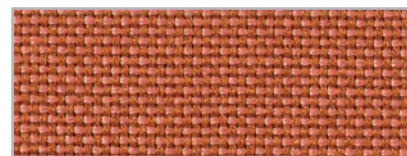

13 - Indian Summer

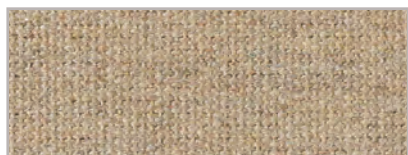

15 - Ashe\*



NEW

29 - Moss



NEW

31 - Copper



NEW

32 - Mahogany

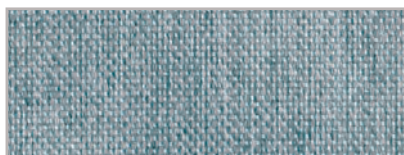

34 - Natté Frost Chiné



40 - Natté Olive

\*This fabric is made with recycled fabric. Due to its specific character, it may show irregularities.

\*Ce tissu est fabriqué avec des tissus recyclés. Des irrégularités peuvent se reproduire ce qui fait partie du caractère spécifique de ce tissu.

\*Deze stof is gemaakt met gerecycleerde stoffen. Hierdoor kunnen onregelmatigheden voorkomen die deel uitmaken van het specifieke karakter van deze stof.

Smooth fabrics are less prone to looping.

Les tissus lisses ont moins tendance à produire des boucles.

Gladde stoffen zijn minder vatbaar voor lusvorming.

# COLORS - COULEURS - KLEUREN

CAT. D

---

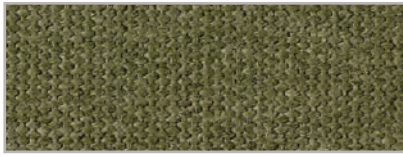

42 - Leaf\*

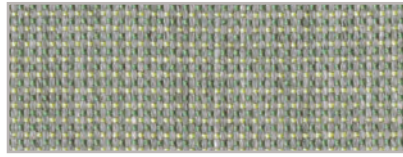

44 - Natté Anis



45 - Natté Mist



46 - Natté Stardust



47 - Natté Ochre

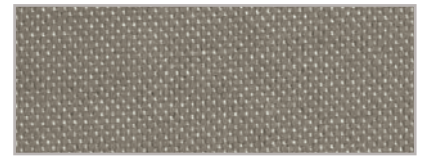

64 - Natté Nature grey



65 - Natté Basalt



69 - Natté Silvergrey



75 - Natté Charcoal



76 - Granite\*



89 - Natté Wengé

The reproduction of colors may differ from reality.  
La représentation des couleurs peut varier de la réalité.  
De weergave van kleuren kan verschillen met de werkelijkheid.



**BASC**



NEW

E51 - Seasalt



NEW

E54 - Flax



NEW

E55 - Alabaster



NEW

E56 - Mellow Ochre

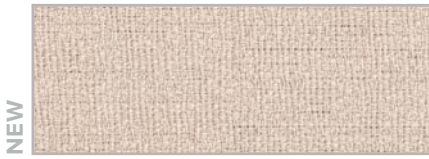

NEW

E57 - Papyrus

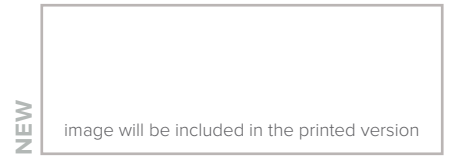

NEW

E91 - Artic

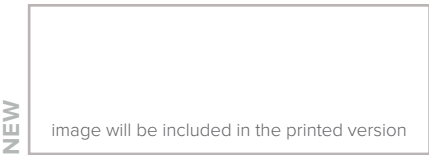

NEW

E93 - Mushroom

\*This fabric is made with recycled fabric. Due to its specific character, it may show irregularities.

\*Ce tissu est fabriqué avec des tissus recyclés. Des irrégularités peuvent se reproduire ce qui fait partie du caractère spécifique de ce tissu.

\*Deze stof is gemaakt met gerecycleerde stoffen. Hierdoor kunnen onregelmatigheden voorkomen die deel uitmaken van het specifieke karakter van deze stof.

Smooth fabrics are less prone to looping.

Les tissus lisses ont moins tendance à produire des boucles.

Gladder stoffen zijn minder vatbaar voor lusvorming.

# COLORS - COULEURS - KLEUREN

CAT. E

---

## YUTTU



E61 - Seasalt



E64 - Flax



E65 - Alabaster

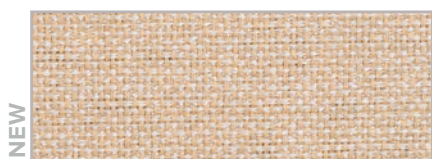

E66 - Mellow Ochre



E67 - Papyrus

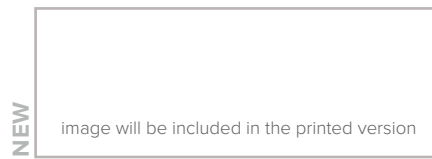

E95 - Artic

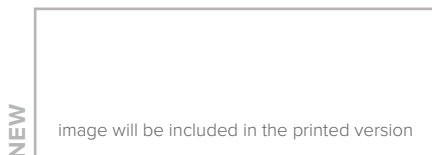

E97 - Mushroom



KNIT



E32 - Morning Dew



E34 - Silverstone



E35 - Dunes



E39 - Wengé

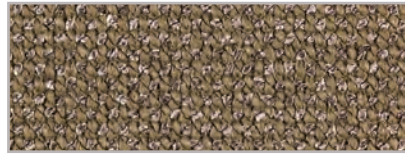

E43 - Rosemary



E44 - Licorice

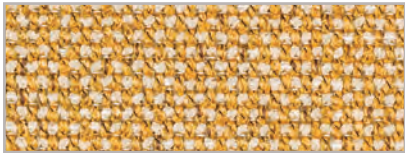

E45 - Mellow Ochre

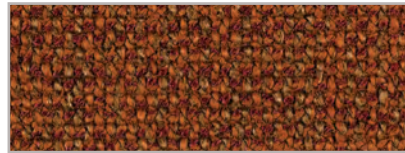

E48 - Dark Copper

Smooth fabrics are less prone to looping.  
Les tissus lisses ont moins tendance à produire des boucles.  
Gladdes stoffen zijn minder vatbaar voor lusvorming.

# COLORS - COULEURS - KLEUREN

CAT. E

---

## NESSO



E70 - Almond

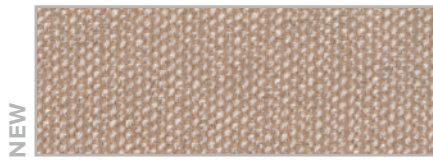

E71 - Ochre Mist



E72 - Carbon Sky



E73 - Sky Mist

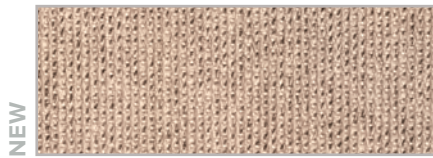

E74 - Ice Blue



E75 - Leaf

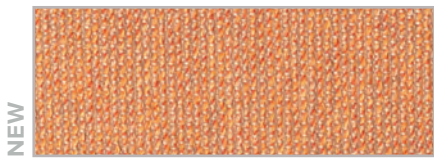

E76 - Sunset



CAT. E

**LINEN**

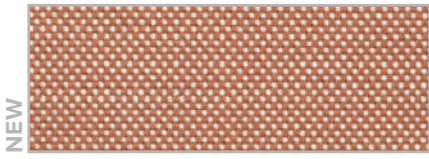

NEW

E79 - Venice



NEW

E80 - Sandstone



NEW

E81 - Linen\*\*



NEW

E82 - White Sand



NEW

E83 - Washed Linen\*\*



NEW

E84 - Chalk\*\*

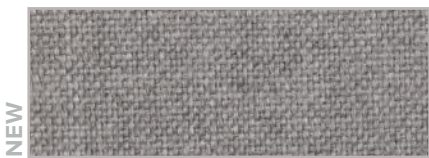

NEW

E85 - Granite

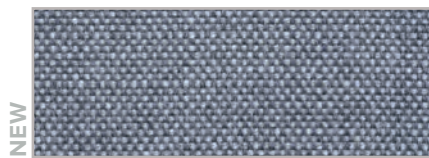

NEW

E86 - Oxford Blue



NEW

E100 - Burgundy



NEW

E101 - Sunset



NEW

E102 - Ruby

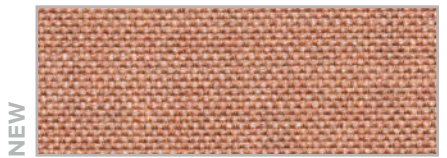

NEW

E103 - Mushroom

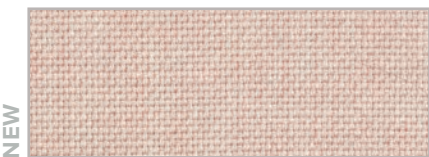

NEW

E104 - Dusty Rose



NEW

E105 - White Quartz

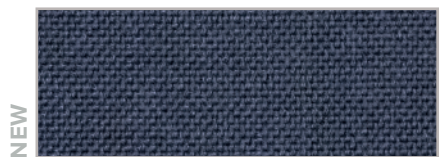

NEW

E107 - Dark Blue



NEW

E108 - Frost Blue



NEW

E109 - Moss



NEW

E111 - Verdant Grey

\*\* For repeat or replacement orders please use the 2024 code numbers, as they differ from the 2025 versions.

Smooth fabrics are less prone to looping.  
 Les tissus lisses ont moins tendance à produire des boucles.  
 Gladde stoffen zijn minder vatbaar voor lusvorming.

CAT. E

---

## RUSTIC WEAVE



B140 - Rustic Weave Dark Grey



B143 - Rustic Weave Oyster



B144 - Rustic Weave Cord



B146 - Rustic Weave Ice Grey



B147 - Rustic Weave Black

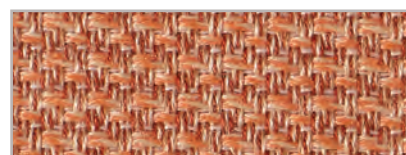

B150 - Rustic Weave Abricot



B151 - Rustic Weave Brown



B152 - Rustic Weave Fresco

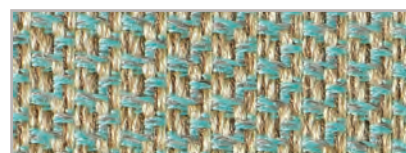

B153 - Rustic Weave Lagoon

## NATURAL



B154 - Natural Seashell



B155 - Natural Cloudy Sky



B156 - Natural Aged Ivory

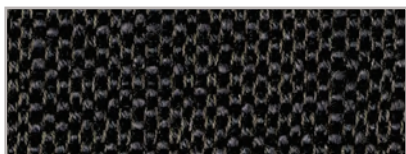

B157 - Natural Umbra



B193 - Natural Off-White

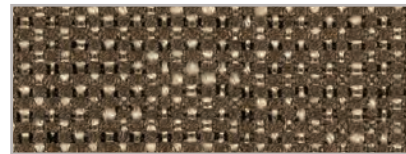

B194 - Natural Dark Brown

The reproduction of colors may differ from reality.  
La représentation des couleurs peut varier de la réalité.  
De weergave van kleuren kan verschillen met de werkelijkheid.



CAT. E

## DUAS

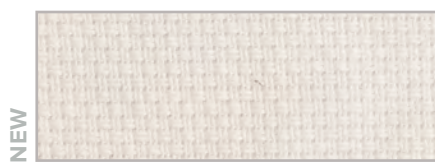

NEW

E120 - Cotton White

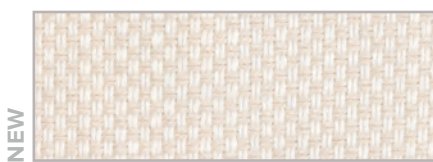

NEW

E121 - Cream White



NEW

E122 - Almond



NEW

E123 - Linen



NEW

E124 - Carbon Sky



NEW

E125 - Wengé

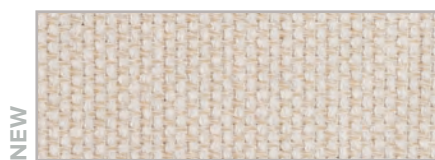

NEW

E130 - Ivory

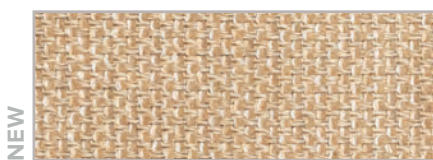

NEW

E131 - Dunes



NEW

E132 - Rustic Brown

Smooth fabrics are less prone to looping.  
Les tissus lisses ont moins tendance à produire des boucles.  
Gladde stoffen zijn minder vatbaar voor lusvorming.

# COLORS - COULEURS - KLEUREN

CAT. F

---

## SUJÀN



F01 - Hemp

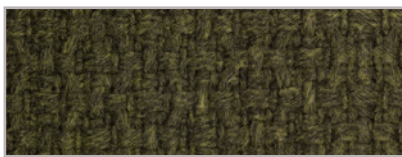

F02 - Moss



F04 - Ochre



NEW

F17 - Nature Grey

## SIVA



NEW

F50 - Cotton White



**NARAM**



F19 - Pearl



F20 - Almond



F21 - Warm Cotton



F80 - Oyster



F81 - Herb



F82 - Rosemary



F84 - Denim



F85 - Frost

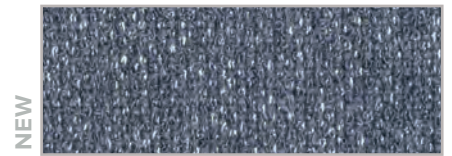

F86 - Indigo



F87 - Moss

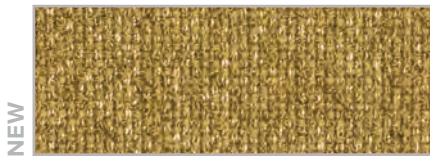

F88 - Verdant



F89 - Ochre



F90 - Copper

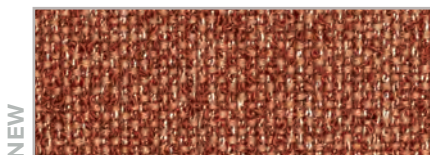

F91 - Merlot

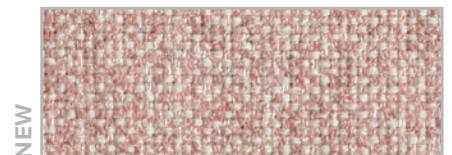

F92 - Cerise

Smooth fabrics are less prone to looping.  
Les tissus lisses ont moins tendance à produire des boucles.  
Gladdes stoffen zijn minder vatbaar voor lusvorming.

# COLORS - COULEURS - KLEUREN

PAVILION & PURE CABANA

---

## SUNSCAPE



S54 - Sunscape Oyster

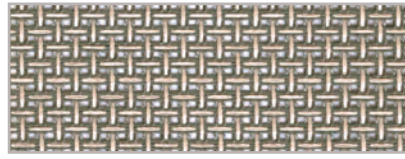

S64 - Sunscape Nature Grey

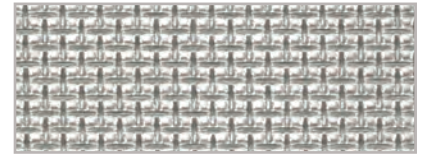

S70 - Sunscape Stone

## VELUM



V54 - Velum Oyster



V64 - Velum Nature Grey



V70 - Velum Stone





# FILLINGS

## REMBOURRAGES - VULLINGEN

### OUTDOOR FILLING

All our cushions are weatherproof, which means you can leave them outside, even during short periods of rain. To preserve the beautiful appearance of the cushions, it is best to keep them indoors during autumn and winter. Depending on the design of the cushions, there are 2 different systems:

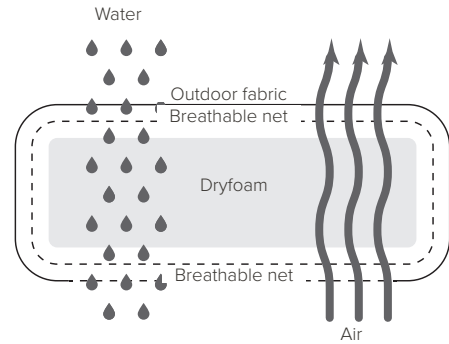
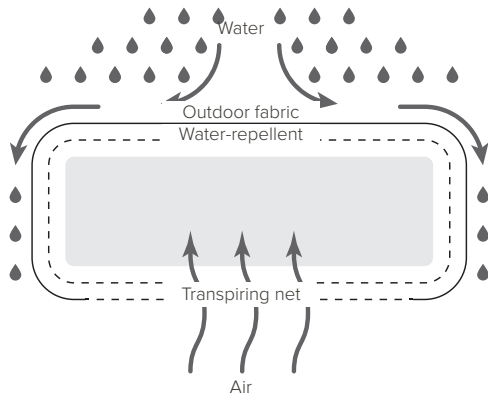

**water-repellent fillings** have a cover in a laminated, water-repellent polypropylene material which prevents water from penetrating. The thread used to stitch the seams swells when getting wet, preventing water from penetrating through the seams. On top of that, the seams are protected on the inside with an extra covering. If nevertheless water should penetrate, the material is breathable, letting moisture out to prevent moulding.

(AMANU, CTR BACK CUSHIONS, ELIO, MOOD SOFA, NATAL ALU SOFA, NODI SOFA, NOMAD, PURE, SENJA, SURO, TOSCA & VIS À VIS SOFA)

**water-permeable fillings (dryfoam)** have an open cell structure so air can circulate freely. Water passes through the filling but dries quickly thanks to the large open pores, substantially inhibiting fungal growth.

(CTR SEAT CUSHIONS, NODI, PAVILION DAYBED, KOS & UKIYO)

### INCOMPARABLE COMFORT

In addition to the water-repellent properties mentioned above, the cushions of our Nodi sofa, Pure sofa and Elio sofa are filled with an innovative, new generation material with a remarkable softness, outstanding shape-retention and excellent breathability.

This new, natural and recyclable polyester fibre is set to change the world of synthetic foams and fibres used for cushion fillings. As a result of its unique molecular structure, it maintains its bounce even after repeated compressions and

quickly recovers its airy volume. Thanks to its high durability, its unique texture is retained for a long time.

The back cushions consist of compartments fully filled with this new fibre, combined with recycled memory-foam particles. This provides excellent support and form stability.

The seat cushions are filled with high quality PU foam with a padding in non-carded microfibre that has been developed for its softness, fluffiness and comfort, creating a seat cushion with the same performance as feathers and down.

(NODI SOFA, PURE SOFA & ELIO SOFA)



Outstanding softness

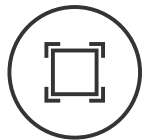

Excellent shape retention



Comfortable stretch



Highly ecological



Superior rebound



## REMBOURRAGE POUR L'EXTÉRIEUR

Tous nos coussins sont résistants aux intempéries. Ils peuvent donc rester dehors, même pendant de courtes périodes de pluie. Afin de conserver au mieux la beauté de vos coussins, nous vous recommandons de les rentrer à l'intérieur en automne et en hiver. Dépendant du design des coussins, il existe deux types de rembourrages différents :

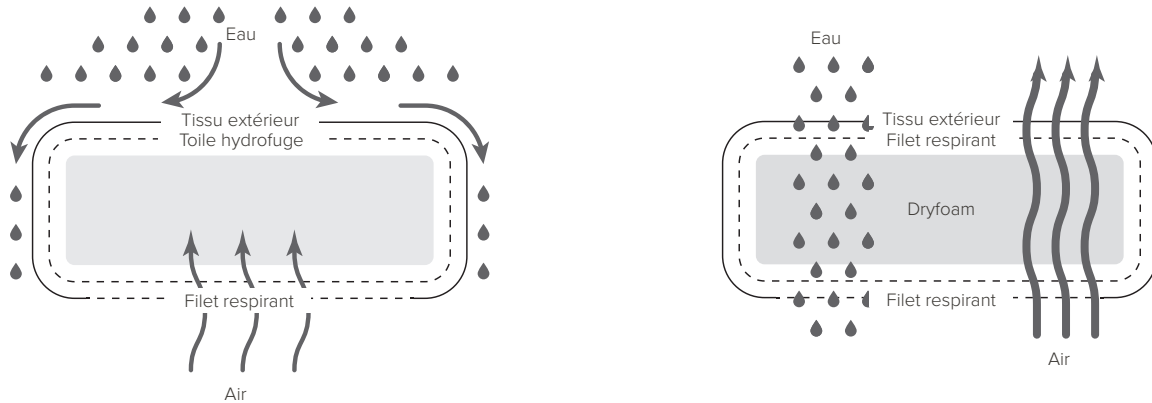

les rembourrages imperméables à l'eau disposent d'une toile en polypropylène laminé hydrofuge, ce qui empêche l'eau d'y pénétrer. Le fil utilisé pour coudre les coutures, gonfle quand il est mouillé, empêchant l'eau de pénétrer à travers les coutures. En plus, les coutures sont protégées à l'intérieur avec une couverture supplémentaire. Si néanmoins de l'eau rentre, le matériau est respirant : il permet à l'humidité de s'évacuer afin d'éviter le risque de moisissure.

(AMANU, CTR COUSSINS DOSSIER, ELIO, MOOD SOFA, NATAL ALU SOFA, NODI SOFA, NOMAD, PURE, SENJA, SURO, TOSCA & VIS À VIS SOFA)

les rembourrages perméables à l'eau (dryfoam) disposent d'une structure à cellules ouvertes ce qui permet à l'air de circuler librement. L'eau passe à travers le rembourrage, mais sèche très rapidement grâce aux larges pores, ce qui limite le risque de moisissure.

(CTR COUSSINS D'ASSISE, NODI, PAVILION DAYBED, KOS & UKIYO)

## UN CONFORT INCOMPARABLE.

En plus des propriétés hydrofuges mentionnées ci-dessus, les coussins de notre canapé Nodi sofa, Pure sofa et Elio sofa sont rembourrés d'un matériau innovant de dernière génération qui offre une douceur remarquable, une excellente mémoire de forme et une respirabilité hors du commun.

Ce nouveau fibre de polyester naturel recyclable va révolutionner le monde de la fibre et de la mousse synthétiques utilisées jusqu'à présent pour le rembourrage des coussins. Grâce à sa structure moléculaire unique, elle retrouve rapidement sa forme et son volume aéré, même après des compressions répétées. Grâce à sa haute résistance, elle

conservera longtemps sa texture unique.

Les coussins de dossier du canapé sont constitués de compartiments entièrement remplis de cette nouvelle fibre, combinée à des particules de mousse à mémoire de forme recyclée. La garantie d'un soutien et d'une stabilité de forme remarquables.

Les coussins de siège sont remplis de mousse PU de haute qualité avec une couche supérieure en microfibre non cardée avec une douceur et un confort comparables à ceux des plumes et du duvet.

(NODI SOFA, PURE SOFA & ELIO SOFA)



Douceur  
exceptionnelle

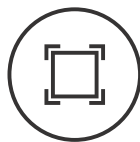

Maintient sa forme



Élasticité confortable

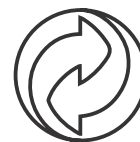

Hautement  
écologique



Excellente  
mémoire de forme

### BUITENVULLING

Al onze kussens zijn weerbestendig waardoor u ze gewoon buiten kan laten liggen, ook tijdens korte periodes van regen. Om uw kussens langer mooi te houden, haalt u ze tijdens de herfst- en winterperiode best binnen. Afhankelijk van het design van de kussens, gebruiken we 2 verschillende systemen:

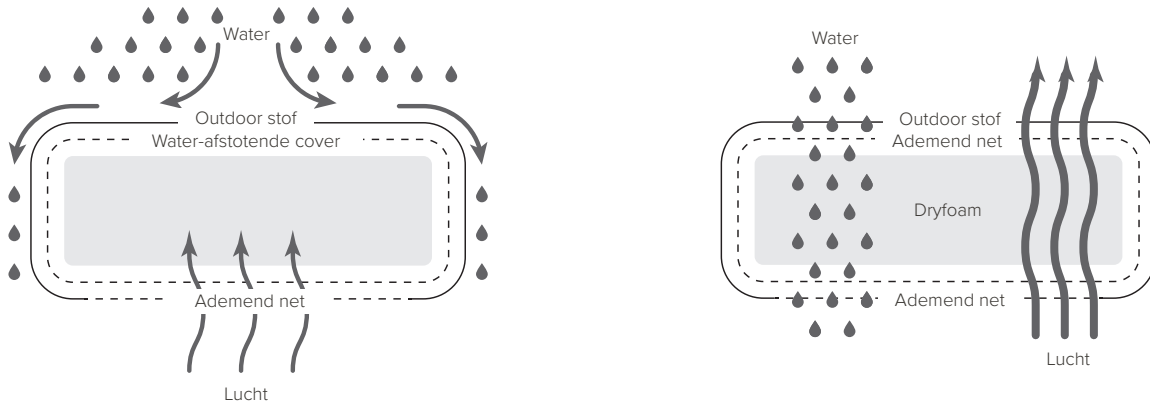

**Waterafstotende kussens** hebben een hoes rond de vulling in gelamineerd, waterafstotend polypropyleen waardoor water niet in de vulling kan binnendringen. De draad die gebruikt wordt om de naden te stikken, zwelt op als hij vochtig wordt, waardoor water ook niet langs de naden kan binnenkomen. Bovendien worden de naden aan de binnenzijde ook nog beschermd met een extra hoesje. Indien water toch nog zou binnensijpelen, kan het vocht eruit omdat de vulling ventilerend is.

(AMANU, CTR RUGKUSSENS, ELIO, MOOD SOFA, NATAL ALU SOFA, NODI SOFA, NOMAD, PURE, SENJA, SURO, TOSCA & VIS À VIS SOFA)

**Waterdoorlaatbare kussens (dryfoam)** hebben een open celstructuur waardoor lucht vrij kan circuleren. Water penetreert door de vulling maar droogt snel dankzij de grote, open poriën waardoor schimmel weinig kans krijgt.

(CTR ZITKUSSENS, NODI, PAVILION DAYBED, KOS & UKIYO)

### EEN ONVERGELIJKBAAR COMFORT.

Bovenop de waterafstotende eigenschappen zoals hierboven vermeld, zijn de kussens van onze Nodi sofa, Pure sofa en Elio sofa gevuld met een innovatief materiaal van de nieuwste generatie met een opmerkelijke zachtheid, perfecte vormvastheid en een uitstekend ademend vermogen. Deze nieuwe, natuurlijke, recycleerbare polyestervezels zullen de wereld van synthetische vezels en schuimvullingen voorgoed veranderen. Dankzij hun unieke moleculaire structuur nemen ze snel terug hun vorm en luchtig volume aan, zelfs na herhaaldelijk samendrukken. Dankzij de hoge duurzaamheid

behouden ze hun unieke textuur voor lange tijd. De rugkussens van de sofa bestaan uit compartimenten die volledig gevuld zijn met deze nieuwe vezels gecombineerd met gerecycleerde memory foam deeltjes. Dit zorgt voor een uitstekende ondersteuning en vormstabiliteit. De zitkussens zijn gevuld met hoogwaardig PU-schuim met een toplaag in niet-gekaarde microvezel met een zachtheid en comfort vergelijkbaar met veren en dons.

(NODI SOFA, PURE SOFA & ELIO SOFA)



Voortreffelijke zachtheid

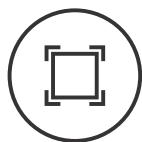

Excellente vormvastheid



Comfortabele stretch



Zeer milieuvriendelijk



Superieure terugvering



# FABRIC TYPES

## TYPES DE TISSUS - STOF TYPES

### INFORMATION

Tribù offers a selection of 124 different outdoor fabrics, all carefully chosen to match our discreet luxury character. Each fabric is engineered with high performance characteristics that provide resistance to fading from sunlight and offer a long life. Durable, yet very tactile. Within our range, we work with 3 different fabric types, see overview beneath. You can find more info on these fabric types on the following pages.

### INFORMATION

Tribù propose une gamme de 124 tissus pour l'extérieur, tous soigneusement choisis afin de correspondre à notre image de luxe discret. Chaque tissu est conçu avec des caractéristiques de haute performance qui offrent une résistance à la décoloration due à la lumière du soleil et une longue durée de vie. Durable, mais aussi très agréable au toucher. Au sein de notre gamme, nous travaillons avec 3 types de tissus différents, voir le tableau ci-dessous. Vous pouvez trouver plus d'informations sur ces types de tissu dans les pages suivantes.

### INFORMATIE

Tribù beschikt over een gamma van 124 verschillende buitenstoffen, allemaal zorgvuldig gekozen om te matchen bij ons discrete luxe karakter. Elke stof is geproduceerd met high-performance kenmerken die weerstaan aan de invloed van de zon en een lange levensduur garanderen. Duurzaam, maar toch zeer tactiel. In ons gamma werken we met 3 verschillend types stof, zie tabel hier beneden. U vindt meer info over deze types stof op de volgende bladzijden.

	SOLUTION DYED ACRYLIC	SOLUTION DYED POLYOLEFIN	PVC COATED POLYESTER
Basc	x		
Duas	x		
Knit		x	
Linen	x		
Naram	x		
Natural	x		
Nesso	x		
Rustic Weave	x		
Siva	x		
Sujàn	x		
Sunbrella®	x		
Sunscape	x		x
Velum	x		
Yuttu	x		

Smooth fabrics are less prone to looping.  
Les tissus lisses ont moins tendance à produire des boucles.  
Gladde stoffen zijn minder vatbaar voor lusvorming.

# SOLUTION DYED ACRYLICS

DES TEXTILES EN ACRYLIQUE TEINTÉS DANS LA MASSE - IN DE MASSA GEVERFD ACRYL

---

BASC, DUAS, LINEN, NARAM, NATURAL, NESSO, RUSTIC WEAVE, SIVA, SUJÀN, SUNBRELLA® & YUTTU

---



## INFORMATION

Acrylic fabrics are durable, high-performance synthetic fabrics made from acrylic fibers. They have a number of advantages including mildew-resistant properties and a minimal absorbency of liquids. The acrylics Tribù uses are solution-dyed which means that they are dyed before the yarn is created. A liquid acrylic solution is mixed with the dye and is then formed into a fiber so it already has color before it is spun into a yarn. This process guarantees an optimal colour fastness. Their ability to breathe prevents mold from building up on the surfaces of the fabric. The open weave provides air flow helping to reduce heat and humidity. In addition to the technical performance, acrylic fabrics have a very soft look and feel, creating the perfect ambiance for your outdoor furniture. Our solution dyed fabrics are treated with a special Teflon® coating to make them water repellent and resistant to stains, grease, fluids and salt or chlorine water.

## MAINTENANCE

The covers of all our cushions can be removed and cleaned. All solution dyed acrylics can be washed at 30° C. After washing we recommend to apply Textile Protector (p. 209) which provides the fabric with an invisible, water- and stain repellent film.

---

## INFORMATION

Les tissus en acrylique sont des textiles synthétiques résistants, de très grande qualité, fabriqués à partir de fibres en acrylique. Ils ont de très nombreux avantages, parmi lesquels des propriétés antifongiques et un degré d'absorption des liquides très faible. Les tissus en acrylique utilisés par Tribù sont teintés dans la masse ce qui signifie qu'ils sont teintés avant même la création du fil de tissage. On mélange une solution liquide acrylique avec le colorant qui est ensuite transformé en fibre. Celle-ci est donc déjà teintée avant d'être filée. Ce processus garantit une tenue optimale des couleurs. Leurs propriétés respirantes ne laissent aucune chance aux moisissures. Par ailleurs, le tissage aéré permet une meilleure circulation de l'air, de sorte que les tissus ne deviennent jamais ni chauds, ni humides. Outre leurs caractéristiques techniques exceptionnelles, les textiles en acrylique présentent un aspect très doux visuellement, mais également au toucher, ce qui permet de recréer en extérieur une atmosphère confortable et agréable. Tous nos tissus subissent un traitement au Teflon®, ce qui les rend hydrofuges, antitaches et résistants à l'eau saline et chlorée.

## ENTRETIEN

Toutes les housses de nos coussins peuvent être retirées afin d'être nettoyées. Tous les tissus en acrylique peuvent être lavés à 30 °C. Après lavage, il est recommandé de vaporiser dessus Textile Protector (p. 209), qui va le protéger d'un film invisible hydrofuge et antitache.

---

## INFORMATIE

Acryl stoffen zijn duurzame, hoogwaardige synthetische stoffen gemaakt van acrylvezels. Ze hebben een aantal voordelen, zoals een weerstand tegen schimmel en een minimale absorptie van vloeistoffen. De acryl die Tribù gebruikt, is in de massa geverfd wat betekent dat de vezels zijn geverfd voordat het garen wordt gemaakt. Een vloeibare acryloplossing wordt gemengd met de kleurstof en vervolgens tot een vezel gevormd, zodat het al kleur heeft voordat het tot garen gesponnen wordt. Dit proces garandeert een optimale kleurvastheid. Hun ademende eigenschappen geven schimmel weinig kans. De open weving zorgt eveneens voor luchtcirculatie waardoor de stoffen niet heet of plakkerig worden. Naast hun bijzondere technische eigenschappen, hebben acryl stoffen ook een zeer zachte look & feel, waardoor ze de perfecte sfeer op uw terras kunnen creëren. Al onze stoffen hebben een Teflon® behandeling gekregen waardoor ze water, vlek- en vetafstotend zijn en bestand tegen zout en chloorwater.

## ONDERHOUD

Alle hoezen van onze kussens kunnen verwijderd worden en gereinigd. Alle acryl stoffen kunnen gewassen worden op 30° C. Na het wassen is het raadzaam om de stof in te spuiten met Textile Protector (p. 209) die een onzichtbare, water- en vlekafstotende film aanbrengt.



# SOLUTION DYED POLYOLEFIN

DES TEXTILES EN POLYOLÉFINE TEINTÉS DANS LA MASSE - IN DE MASSA GEVERFD POLYOLEFIN

KNIT



## INFORMATION

Solution dyed polyolefin fabrics are the perfect combination of ecology (100% recyclable), durability and performance, being twice as strong as acrylics. Polyolefin fabrics are resistant to water, mildew and stains. Combined with their high abrasion and pilling resistance, it makes them the perfect fabrics for your outdoor furniture. Their UV-resistance is dependent on the colour and might be lower than solution dyed acrylic fabrics (test results can be found on the back of your sample swatch and on p. 160). In case of lower results, slight fading of the colour might occur after 2 years.

## MAINTENANCE

The cover of all our cushions can be removed and cleaned. All solution-dyed polyolefin fabrics can be washed at 30° C. After washing we recommend to apply Textile Protector (p. 209) which provides the fabric with an invisible, water- and stain repellent film.

## INFORMATION

Les tissus en polyoléfine teintés dans la masse constituent l'alliance parfaite entre écologie (100 % recyclables), caractère inusable et haute qualité, étant deux fois plus résistants que les tissus en acrylique. Ils sont imperméables, hydrofuges et antitaches. Le fait qu'ils soient également anti-abrasifs et anti-peluches, en font des tissus parfaits pour habiller vos meubles d'extérieur. Leur résistance aux UV est variable selon la couleur et peut être moins efficace que pour des tissus en acrylique teintés dans la masse (vous pourrez consulter les résultats des tests au dos de chaque coupon de tissu ou p. 160). En cas de moins bons résultats, on observe en général un début de décoloration au bout de 2 ans.

## ENTRETIEN

Toutes les housses de nos coussins peuvent être retirées et nettoyées. Tous les tissus en polyoléfine peuvent être lavés à 30 °C. Après lavage, il est recommandé de vaporiser dessus Textile Protector (p. 209), qui va le protéger d'un film invisible hydrofuge et antitache.

## INFORMATIE

In de massa geleverde polyolefin stoffen, zijn de perfecte combinatie van milieuvriendelijkheid (100% recycleerbaar), duurzaamheid en prestatie. Ze zijn dubbel zo sterk als acrylstoffen. Polyolefin stoffen zijn water-, schimmel- en vlekbestendig. In combinatie met hun hoge weerstand tegen wrijving en pluizen, zijn dit de perfecte stoffen voor uw buitenmeubelen. Hun UV-weerstand is afhankelijk van de kleur en zou lager kunnen zijn dan in de massa geleverd acryl (testresultaten vindt u aan de achterkant van uw stofstalenbundel of op p. 160). In het geval van lagere resultaten, kan lichte vervaging van de kleur optreden na 2 jaar.

## ONDERHOUD

Alle hoezen van onze kussens kunnen verwijderd worden en gereinigd. Alle polyolefin stoffen kunnen gewassen worden op 30° C. Na het wassen is het raadzaam om de stof in te spuiten met Textile Protector (p. 209) die een onzichtbare, water- en vlekafstotende film aanbrengt.

# PVC COATED POLYESTER

POLYESTER ENDUIT DE PVC - PVC GECOAT POLYESTER

---

SUNSCAPE

---



## INFORMATION

These fabrics are composed of polyester that is coated with PVC. The polyester provides strength and dimensional stability, while the PVC coating makes the material waterproof and resistant to dirt, mildew, oil, salt, chemicals and UV rays. It also gives the material added strength and durability.

## MAINTENANCE

PVC coated fabrics are very maintenance friendly and can easily be cleaned with clear water, a pH- neutral soap and a soft brush. Rinse with clear water. Stubborn stains can be removed with Synthetics Super Cleaner (p. 208).

---

## INFORMATION

Ces tissus sont composés de polyester, recouvert de PVC. Le polyester assure solidité et stabilité dimensionnelle, tandis que l'enduit de PVC rend le matériau imperméable et résistant à la saleté, la moisissure, huile, sel, produits chimiques et aux rayons UV. En plus, il augmente encore la solidité et durabilité.

## ENTRETIEN

Le polyester enduit de PVC est très facile à entretenir et se nettoie aisément avec de l'eau pure, un savon à pH neutre et une brosse douce. Rincez ensuite à l'eau propre. Les taches récalcitrantes peuvent être éliminées avec le Synthetics Super Cleaner (p. 208).

---

## INFORMATIE

Deze stoffen zijn samengesteld uit polyester dat gecoat wordt met PVC. De polyester biedt sterkte en dimensionale stabiliteit, terwijl de PVC-coating het materiaal waterdicht maakt en bestand tegen vuil, schimmel, olie, zout, chemicaliën en UV-stralen. Het voegt ook extra sterkte en duurzaamheid toe.

## ONDERHOUD

Deze stoffen zijn zeer onderhoudsvriendelijk en kunnen gemakkelijk gereinigd worden met zuiver water, een pH-neutrale zeep en een zachte borstel. Naspoelen met zuiver water. Hardnekkige vlekken kunnen verwijderd worden met de Synthetics Super Cleaner (p. 208).



# FABRIC PROPERTIES

PROPRIÉTÉS DES TISSUS - STOFFEIGENSCHAPPEN

	Code	Category	Composition	Weight (g/m <sup>2</sup> )
<b>SUNBRELLA®</b>				
Natté White	01	Cat. D	Sunbrella® Solution dyed acrylic	290
Oyster	03	Cat. D	Sunbrella® Solution dyed acrylic	280
Natté Sandstone <b>NEW</b>	04	Cat. D	Sunbrella® Solution dyed acrylic	290
Natté Poivre <b>NEW</b>	05	Cat. D	Sunbrella® Solution dyed acrylic	290
Natté Dune	06	Cat. D	Sunbrella® Solution dyed acrylic	290
Papyrus*	07	Cat. D	Sunbrella® 50% recycled acrylic - 47% acrylic - 3% PE	340
Natté Carbon Sky	08	Cat. D	Sunbrella® Solution dyed acrylic	290
Blush	11	Cat. D	Sunbrella® Solution dyed acrylic	260
Indian Summer	13	Cat. D	Solution dyed acrylic	275
Ashe*	15	Cat. D	Sunbrella® 50% recycled acrylic - 47% acrylic - 3% PE	340
Moss	29	Cat. D	Sunbrella® 50% recycled acrylic - 47% acrylic - 3% PE	365
Copper	31	Cat. D	Sunbrella® 50% recycled acrylic - 47% acrylic - 3% PE	335
Mahogany	32	Cat. D	Sunbrella® 50% recycled acrylic - 47% acrylic - 3% PE	335
Natté Frost Chiné	34	Cat. D	Sunbrella® Solution dyed acrylic	290
Natté Olive	40	Cat. D	Sunbrella® Solution dyed acrylic	290
Leaf*	42	Cat. D	Sunbrella® 50% recycled acrylic - 47% acrylic - 3% PE	340
Natté Anis	44	Cat. D	Sunbrella® Solution dyed acrylic	290
Natté Mist	45	Cat. D	Sunbrella® Solution dyed acrylic	290
Natté Stardust	46	Cat. D	Sunbrella® Solution dyed acrylic	290
Natté Ochre	47	Cat. D	Sunbrella® solution dyed acrylic	290
Natté Nature Grey	64	Cat. D	Sunbrella® Solution dyed acrylic	290
Natté Basalt	65	Cat. D	Sunbrella® Solution dyed acrylic	290
Natté Silvergrey	69	Cat. D	Sunbrella® Solution dyed acrylic	290
Natté Charcoal	75	Cat. D	Sunbrella® Solution dyed acrylic	290
Granite*	76	Cat. D	Sunbrella® 50% recycled acrylic - 47% acrylic - 3% PE	340
Natté Wengé	89	Cat. D	Sunbrella® Solution dyed acrylic	290

<b>BASC &amp; YUTTU</b>				
Seasalt <b>NEW</b>	E51   E61	Cat. D	Solution dyed acrylic	501
Flax <b>NEW</b>	E54   E64	Cat. D	Solution dyed acrylic	501
Alabaster <b>NEW</b>	E55   E65	Cat. D	Solution dyed acrylic	501
Mellow Ochre <b>NEW</b>	E56   E66	Cat. D	Solution dyed acrylic	501
Papyrus <b>NEW</b>	E57   E67	Cat. D	Solution dyed acrylic	501
Artic <b>NEW</b>	E91   E95	Cat. D	Solution dyed acrylic	501
Mushroom <b>NEW</b>	E93   E97	Cat. D	Solution dyed acrylic	501

<b>DUAS</b>				
Cotton White <b>NEW</b>	E120	Cat. D	Solution dyed acrylic	640
Cream White <b>NEW</b>	E121	Cat. D	Solution dyed acrylic	640
Almond <b>NEW</b>	E122	Cat. D	Solution dyed acrylic	640
Linen <b>NEW</b>	E123	Cat. D	Solution dyed acrylic	640
Carbon Sky <b>NEW</b>	E124	Cat. D	Solution dyed acrylic	640
Wengé <b>NEW</b>	E125	Cat. D	Solution dyed acrylic	640
Ivory <b>NEW</b>	E130	Cat. D	Solution dyed acrylic	480
Dunes <b>NEW</b>	E131	Cat. D	Solution dyed acrylic	480
Rustic Brown <b>NEW</b>	E132	Cat. D	Solution dyed acrylic	480

\*This fabric is made with recycled fabric. Due to its specific character, it may show irregularities.

\*Ce tissu est fabriqué avec des tissus recyclés. Des irrégularités peuvent se reproduire ce qui fait partie du caractère spécifique de ce tissu.

\*Deze stof is gemaakt met gerecycleerde stoffen. Hierdoor kunnen onregelmatigheden voorkomen die deel uitmaken van het specifieke karakter van deze stof.

	Code	Abrasion Resistance Martindale	Colour fastness to UV scale of 1-5	Pilling scale of 1-5
<b>SUNBRELLA®</b>				
Natté White	01	25.000	3-4	5
Oyster	03	20.000	5	4-5
Natté Sandstone <b>NEW</b>	04	>40.000	3-4	4-5
Natté Poivre <b>NEW</b>	05	>40.000	3-4	4-5
Natté Dune	06	25.000	3-4	5
Papyrus*	07	25.000	3-4	5
Natté Carbon Sky	08	25.000	4	5
Blush	11	25.000	4	5
Indian Summer	13	12.000	4	3
Ashe*	15	25.000	4-5	5
Moss	29	>40.000	4	4-5
Copper	31	>40.000	4-5	4-5
Mahogany	32	>40.000	4-5	4-5
Natté Frost Chiné	34	25.000	4-5	5
Natté Olive	40	25.000	4	5
Leaf*	42	25.000	4-5	5
Natté Anis	44	25.000	4-5	5
Natté Mist	45	25.000	4-5	5
Natté Stardust	46	25.000	4	5
Natté Ochre	47	25.000	4-5	5
Natté Nature Grey	64	25.000	4-5	5
Natté Basalt	65	25.000	4-5	5
Natté Silvergrey	69	25.000	3-4	5
Natté Charcoal	75	25.000	4-5	5
Granite*	76	25.000	4-5	5
Natté Wengé	89	25.000	4-5	5

<b>BASC &amp; YUTTU</b>				
Seasalt <b>NEW</b>	E51   E61	20.000	4	4
Flax <b>NEW</b>	E54   E64	20.000	4	4
Alabaster <b>NEW</b>	E55   E65	20.000	4	4
Mellow Ochre <b>NEW</b>	E56   E66	20.000	4	4
Papyrus <b>NEW</b>	E57   E67	20.000	4	4
Artic <b>NEW</b>	E91   E95	20.000	4	4
Mushroom <b>NEW</b>	E93   E97	20.000	4	4

<b>DUAS</b>				
Cotton White <b>NEW</b>	E120	30.000	3-4	4
Cream White <b>NEW</b>	E121	30.000	3-4	4
Almond <b>NEW</b>	E122	30.000	3-4	4
Linen <b>NEW</b>	E123	30.000	3-4	4
Carbon Sky <b>NEW</b>	E124	30.000	3-4	4
Wengé <b>NEW</b>	E125	30.000	3-4	4
Ivory <b>NEW</b>	E130	20.000	3-4	4
Dunes <b>NEW</b>	E131	20.000	3-4	4
Rustic Brown <b>NEW</b>	E132	20.000	3-4	4



# FABRIC PROPERTIES

PROPRIÉTÉS DES TISSUS - STOFFEIGENSCHAPPEN

	Code	Category	Composition	Weight (g/m <sup>2</sup> )
<b>KNIT</b>				
Morning Dew	E32	Cat. E	100% solution dyed polyolefin	710
Silverstone	E34	Cat. E	100% solution dyed polyolefin	710
Dunes <b>NEW</b>	E35	Cat. E	100% solution dyed polyolefin	995
Wengé	E39	Cat. E	100% solution dyed polyolefin	710
Rosemary	E43	Cat. E	100% solution dyed polyolefin	710
Licorice	E44	Cat. E	100% solution dyed polyolefin	710
Mellow Ochre	E45	Cat. E	100% solution dyed polyolefin	710
Dark Copper	E48	Cat. E	100% solution dyed polyolefin	710

<b>LINEN</b>				
Venice <b>NEW</b>	E79	Cat. E	Solution dyed acrylic	592
Sandstone <b>NEW</b>	E80	Cat. E	Solution dyed acrylic	530
Linen <b>NEW</b>	E81	Cat. E	Solution dyed acrylic	530
White sand <b>NEW</b>	E82	Cat. E	Solution dyed acrylic	530
Washed linen <b>NEW</b>	E83	Cat. E	Solution dyed acrylic	530
Chalk <b>NEW</b>	E84	Cat. E	Solution dyed acrylic	530
Granite <b>NEW</b>	E85	Cat. E	Solution dyed acrylic	540
Oxford Blue <b>NEW</b>	E86	Cat. E	Solution dyed acrylic	592
Burgundy <b>NEW</b>	E100	Cat. E	Solution dyed acrylic	592
Sunset <b>NEW</b>	E101	Cat. E	Solution dyed acrylic	592
Ruby <b>NEW</b>	E102	Cat. E	Solution dyed acrylic	592
Mushroom <b>NEW</b>	E103	Cat. E	Solution dyed acrylic	592
Dusty Rose <b>NEW</b>	E104	Cat. E	Solution dyed acrylic	592
White Quartz <b>NEW</b>	E105	Cat. E	Solution dyed acrylic	530
Dark Blue <b>NEW</b>	E107	Cat. E	Solution dyed acrylic	592
Frost Blue <b>NEW</b>	E108	Cat. E	Solution dyed acrylic	540
Moss <b>NEW</b>	E109	Cat. E	Solution dyed acrylic	592
Verdant Grey <b>NEW</b>	E111	Cat. E	Solution dyed acrylic	592

<b>NATURAL</b>				
Seashell	B154	Cat. E	Solution dyed acrylic	365
Cloudy Sky	B155	Cat. E	Solution dyed acrylic	365
Aged Ivory	B156	Cat. E	Solution dyed acrylic	365
Umbra	B157	Cat. E	Solution dyed acrylic	365
Off-White	B193	Cat. E	Solution dyed acrylic	365
Dark Brown	B194	Cat. E	Solution dyed acrylic	365

<b>NESSO</b>				
Almond <b>NEW</b>	E70	Cat. E	Solution dyed acrylic	450
Ochre Mist <b>NEW</b>	E71	Cat. E	Solution dyed acrylic	450
Carbon Sky <b>NEW</b>	E72	Cat. E	Solution dyed acrylic	450
Sky Mist <b>NEW</b>	E73	Cat. E	Solution dyed acrylic	450
Ice Blue <b>NEW</b>	E74	Cat. E	Solution dyed acrylic	450
Leaf <b>NEW</b>	E75	Cat. E	Solution dyed acrylic	450
Sunset <b>NEW</b>	E76	Cat. E	Solution dyed acrylic	450

Code	Abrasion Resistance Martindale	Colour fastness to UV scale of 1-5	Pilling scale of 1-5
------	-----------------------------------	---------------------------------------	-------------------------

KNIT				
Morning Dew	E32	40.000	3-4	4.5
Silverstone	E34	40.000	3-4	4.5
Dunes <b>NEW</b>	E35	40.000	3	4-5
Wengé	E39	40.000	3-4	4.5
Rosemary	E43	40.000	3-4	4.5
Licorice	E44	40.000	3	4.5
Mellow Ochre	E45	40.000	3	4.5
Dark Copper	E48	40.000	2	4.5

LINEN				
Venice <b>NEW</b>	E79	15.000	4	4
Sandstone <b>NEW</b>	E80	15.000	4	4
Linen <b>NEW</b>	E81	20.000	3	4
White sand <b>NEW</b>	E82	20.000	3	4
Washed linen <b>NEW</b>	E83	20.000	3	4
Chalk <b>NEW</b>	E84	20.000	3	4
Granite <b>NEW</b>	E85	20.000	3	4
Oxford Blue <b>NEW</b>	E86	20.000	3	4
Burgundy <b>NEW</b>	E100	40.000	3	4-5
Sunset <b>NEW</b>	E101	40.000	3	4-5
Ruby <b>NEW</b>	E102	40.000	3	4-5
Mushroom <b>NEW</b>	E103	40.000	3	4-5
Dusty Rose <b>NEW</b>	E104	40.000	3	4-5
White Quartz <b>NEW</b>	E105	40.000	3	4-5
Dark Blue <b>NEW</b>	E107	40.000	3	4-5
Frost Blue <b>NEW</b>	E108	40.000	3	4-5
Moss <b>NEW</b>	E109	40.000	3	4-5
Verdant Grey <b>NEW</b>	E111	40.000	3	4-5

NATURAL				
Seashell	B154	25.000	4	4
Cloudy Sky	B155	25.000	4-5	4
Aged Ivory	B156	25.000	4	4
Umbra	B157	25.000	4-5	4
Off-White	B193	25.000	5	4
Dark Brown	B194	25.000	5	4

NESSO				
Almond <b>NEW</b>	E70	12.000	3	4-5
Ochre Mist <b>NEW</b>	E71	12.000	3	4-5
Carbon Sky <b>NEW</b>	E72	15.000	3	4-5
Sky Mist <b>NEW</b>	E73	15.000	3	4-5
Ice Blue <b>NEW</b>	E74	15.000	3	4-5
Leaf <b>NEW</b>	E75	15.000	3	4-5
Sunset <b>NEW</b>	E76	15.000	3	4-5



# FABRIC PROPERTIES

PROPRIÉTÉS DES TISSUS - STOFFEIGENSCHAPPEN

	Code	Category	Composition	Weight (g/m <sup>2</sup> )
<b>RUSTIC WEAVE</b>				
Dark Grey	B140	Cat. E	Solution dyed acrylic	400
Oyster	B143	Cat. E	Solution dyed acrylic	400
Cord	B144	Cat. E	Solution dyed acrylic	470
Ice Grey	B146	Cat. E	Solution dyed acrylic	470
Black	B147	Cat. E	Solution dyed acrylic	400
Abricot	B150	Cat. E	Solution dyed acrylic	400
Brown	B151	Cat. E	Solution dyed acrylic	400
Fresco	B152	Cat. E	Solution dyed acrylic	400
Lagoon	B153	Cat. E	Solution dyed acrylic	400
<b>NARAM</b>				
Pearl	<b>NEW</b> F19	Cat. F	Solution dyed acrylic	1.360
Almond	<b>NEW</b> F20	Cat. F	Solution dyed acrylic	1.360
Warm Cotton	<b>NEW</b> F21	Cat. F	Solution dyed acrylic	1.360
Oyster	<b>NEW</b> F80	Cat. F	Solution dyed acrylic	971
Herb	<b>NEW</b> F81	Cat. F	Solution dyed acrylic	971
Rosemary	<b>NEW</b> F82	Cat. F	Solution dyed acrylic	971
Frost	<b>NEW</b> F84	Cat. F	Solution dyed acrylic	971
Denim	<b>NEW</b> F85	Cat. F	Solution dyed acrylic	971
Indigo	<b>NEW</b> F86	Cat. F	Solution dyed acrylic	971
Moss	<b>NEW</b> F87	Cat. F	Solution dyed acrylic	971
Verdant	<b>NEW</b> F88	Cat. F	Solution dyed acrylic	971
Ochre	<b>NEW</b> F89	Cat. F	Solution dyed acrylic	971
Copper	<b>NEW</b> F90	Cat. F	Solution dyed acrylic	971
Merlot	<b>NEW</b> F91	Cat. F	Solution dyed acrylic	971
Cerise	<b>NEW</b> F92	Cat. F	Solution dyed acrylic	971
<b>SIVA</b>				
Cotton White	<b>NEW</b> F50	Cat. F	Solution dyed acrylic	700
<b>SUJÀN</b>				
Hemp	F01	Cat. F	Solution dyed acrylic	1.000
Moss	F02	Cat. F	Solution dyed acrylic	1.000
Ochre	F04	Cat. F	Solution dyed acrylic	1.000
Nature Grey	<b>NEW</b> F17	Cat. F	Solution dyed acrylic	971
<b>BATYLINE</b>				
White	00		Batylite®	
Silkgrey	71		Batylite® Canatex	
Wengé	89		Batylite®	
<b>PAVILION &amp; PURE CABANA</b>				
Sunscape Oyster	S54		98% Polyester 2% hemp	600
Sunscape Nature Grey	S64		98% Polyester 2% hemp	600
Sunscape Stone	S70		98% Polyester 2% hemp	600
<b>Velum</b>				
Velum Oyster	V54		Sunbrella® Solution dyed acrylic	165
Velum Nature Grey	V64		Sunbrella® Solution dyed acrylic	165
Velum Stone	V70		Sunbrella® Solution dyed acrylic	165

Code	Abrasion Resistance Martindale	Colour fastness to UV scale of 1-5	Pilling scale of 1-5	
<b>RUSTIC WEAVE</b>				
Dark Grey	B140	12.000	4	3-4
Oyster	B143	12.000	4	3-4
Cord	B144	21.000	4	3-4
Ice Grey	B146	21.000	4	3-4
Black	B147	12.000	4-5	3-4
Abricot	B150	12.000	3-4	3-4
Brown	B151	12.000	4-5	3-4
Fresco	B152	12.000	3-4	3-4
Lagoon	B153	12.000	4	3-4
<b>NARAM</b>				
Pearl	<b>NEW</b> F19	25.000	4-5	4
Almond	<b>NEW</b> F20	25.000	4-5	4
Warm Cotton	<b>NEW</b> F21	25.000	4-5	4
Oyster	<b>NEW</b> F80	30.000	3	4
Herb	<b>NEW</b> F81	30.000	3	4
Rosemary	<b>NEW</b> F82	30.000	3	4
Frost	<b>NEW</b> F84	30.000	3	4
Denim	<b>NEW</b> F85	30.000	3	4
Indigo	<b>NEW</b> F86	30.000	3	4
Moss	<b>NEW</b> F87	30.000	3	4
Verdant	<b>NEW</b> F88	30.000	3	4
Ochre	<b>NEW</b> F89	30.000	3	4
Copper	<b>NEW</b> F90	30.000	3	4
Merlot	<b>NEW</b> F91	30.000	3	4
Cerise	<b>NEW</b> F92	30.000	3	4
<b>SIVO</b>				
Siva Cotton White	<b>NEW</b> F50	25.000	3-4	4
<b>SUJÀN</b>				
Hemp	F01	5.000	4	3-4
Moss	F02	5.000	4	3-4
Ochre	F04	5.000	4	3-4
Nature Grey	<b>NEW</b> F17	5.000	4	3-4
<b>BATYLINE</b>				
White	00	120.000	4	-
Silkgrey	71	120.000	4	-
Wengé	89	120.000	4	-
<b>PAVILION &amp; PURE CABANA</b>				
Sunscape Oyster	S54	>40.000	4	-
Sunscape Nature Grey	S64	>40.000	4	-
Sunscape Stone	S70	>40.000	4	-
Velum Oyster	V54	40.000	4-5	-
Velum Nature Grey	V64	40.000	4-5	-
Velum Stone	V70	40.000	4-5	-





# LEGEND FABRIC PROPERTIES

## LÉGENDE PROPRIÉTÉS DES TISSUS - LEGENDE STOFFEIGENSCHAPPEN

---

**Abrasion resistance:** fabric's ability to withstand surface wear from rubbing.

**Martindale test**

Fabric is mounted flat and rubbed in a figure eight-like motion using an abrasive surface. The number of cycles endured before the fabric shows an objectionable change in appearance is counted and determines the fabric's abrasion rating.  
20.000 = general contract upholstery  
40.000 = heavy duty upholstery

**Colour fastness**

The fabrics are tested for UV resistance with an aging accelerator in compliance with ISO standard 4892-2 for 5.000 hours and outdoors in Florida, Indonesia and Belgium. Based on these tests the fabrics are awarded a maximum score of 5.

**Pilling**

The fabric's propensity to pilling. Maximum score is 5 (= least inclined).

---

**Résistance à l'abrasion:** la résistance à l'usure induite par le frottement de textiles.

**Test Martindale**

Le tissu est monté à plat et frotté dans un mouvement en forme huit en utilisant un abrasif. Le nombre de cycles endurés avant que le tissu ne montre un changement d'aspect sensible est compté et détermine le taux d'abrasion du tissu.  
20.000 = tissu à usage général dans le secteur contrat  
40.000 = tissu à usage intensif

**Solidité à la lumière aux intempéries**

Tous les tissus sont testés aussi par nous-mêmes pendant 5.000 heures avec un accélérateur de vieillissement en conformité avec la norme ISO 4892-2 et à l'extérieur en Floride, Indonésie et la Belgique. Le score maximal attribué est 5.

**Pilling**

La propension du tissu au boulochage. Le score maximal est 5 (= le moins incliné).

---

**Slijtvastheid:** geeft de weerstand van de stof aan tegen slijtage door wrijving.

**Martindale test**

Over de strak getrokken stof wordt met behulp van een schuuroppervlak gewreven in een achtvorm. Het aantal cycli dat de stof ondergaat voordat er merkbare slijtage optreedt wordt geteld en bepaalt de slijtvastheid.  
20.000 = algemene contract stoffering  
40.000 = stoffering voor intensief gebruik

**Kleurvastheid bij ververing**

We testen de stoffen zelf ook nog op UV-bestendigheid met een verouderingsversneller gedurende 5.000 uren volgens de ISO standaard 4892-2 en op buitenlandse locaties in Florida, Indonesië en België.  
Op basis hiervan geven we een score van maximaal 5.

**Pilling**

De neiging van de stof tot pillen. De maximum score is 5 (= minste neiging).









**INFORMATION**

Aluminium is a non-ferrous metal, which combines great mechanical rigidity with light weight. This makes it especially suitable for furniture. If treated correctly, it has a good resistance to corrosion. By powdercoating aluminium, this corrosion resistance can even be enhanced. After a chemical pre-treatment, an epoxy powder is applied statically and baked. Tribù always uses European, ultra-durable and scratch-resistant polyester powdercoatings that guarantee a UV-resistance of 15 years. For certain collections (Branch & Illum) parts of the frame are die-cast under high pressure which results in a seamless and extremely solid frame. Additionally, an extra epoxy primer coat is applied for these collections.

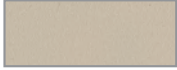
**MAINTENANCE**

Powder coated aluminium is easy to clean with clear water and a pH-neutral fluid detergent. Stubborn stains can be removed with Coated aluminium & stainless steel Cleaner (p. 206). If necessary, use a soft brush to remove the dirt from the pores. To protect the frame against the adhesion of dirt, Coated aluminium & stainless steel Protector (p. 206) can be used which applies an invisible protective film.

**INFORMATION**

L'aluminium est un métal non ferreux qui combine une grande rigidité mécanique à un faible poids. Il convient ainsi idéalement pour la fabrication de mobilier. Moyennant un traitement correct, l'aluminium présente une résistance élevée à la corrosion. Cette résistance à la corrosion peut encore être optimisée en appliquant un laquage en poudre à l'aluminium. Après un prétraitement chimique, une poudre époxy est appliquée par voie statique, puis cuite.

Tribù utilise toujours des laques polyester en poudre européennes ultra durables, avec une résistance aux UV de 15 ans. Dans certaines collections (Branch & Illum), les pièces en aluminium sont moulées sous haute pression, ce qui crée un cadre sans soudures et très robuste. Pour ces collections, on utilise en plus une couche additionnelle de primer époxy.

**ENTRETIEN**

L'aluminium est facile à entretenir avec de l'eau pure et un détergent liquide à pH neutre. Vous pouvez éliminer les taches récalcitrantes avec de l'Coated aluminium & stainless steel Cleaner (p. 206). Si nécessaire, employez une brosse douce pour éliminer les saletés dans les pores. Pour protéger le cadre contre l'incrustation de saletés, on peut employer Coated aluminium & stainless steel Protector (p. 206), qui applique une couche de protection invisible.

**INFORMATIE**

Aluminium is een non-ferro metaal dat een hoge mechanische stijfheid combineert met een licht gewicht. Dit maakt het bijzonder geschikt voor meubilair. Indien correct behandeld, heeft aluminium een grote weerstand tegen corrosie. Door aluminium te poederlakken kan deze corrosiebestendigheid nog verder opgedreven worden. Na een chemische voorbehandeling wordt een epoxy poeder statisch toegepast en gebakken. Tribù gebruikt steeds Europese, ultra-durable en krasbestendige polyesterpoederlakken met een UV-bestendigheid van 15 jaar. Bij bepaalde collecties (Branch & Illum) worden delen van het aluminium onder hoge druk spuitgegoten waardoor een naadloos en zeer sterk frame ontstaat. Bij deze collecties wordt bovendien een extra laag epoxy primer toegepast.

**ONDERHOUD**

Aluminium is makkelijk te onderhouden met zuiver water en een pH-neutraal, vloeibaar detergent. Hardnekkige vlekken kan u verwijderen met Coated aluminium & stainless steel Cleaner (pag. 206). Gebruik indien nodig een zachte borstel om vuil uit de poriën te verwijderen. Om het frame te beschermen tegen vasthechten van vuil, kan Coated aluminium & stainless steel Protector (p. 206) gebruikt worden dat een onzichtbare beschermlaag aanbrengt.

BRANCH, FORUM, ILLUM, NATAL ALU, PAVILION, SENJA & TOSCA



## INFORMATION

Batyline® is a polyester fibre which is coated with solution dyed PVC and then woven. The fibres are then melted together to create an extremely stretch and tear-resistant fabric that keeps its shape perfectly. Apart from its exceptional mechanical strength, it has a high chemical resistance. The synthetic coating guarantees an extremely high weather and UV-resistance. The fact that no moisture is absorbed, results in rapid drying, maximum stain and mould-resistance and simple cleaning. The most important feature is its pliancy and optimal seating comfort.

Canatex® is the marriage between Batyline® and a natural fibre, hemp. The combination of the two leads to more subtle colours and a natural touch, leaving all the technological advantages of the product untouched.

## MAINTENANCE

Batyline® is easy to clean with clear water and a pH-neutral soap. Stubborn stains can be removed with Synthetics Super Cleaner (p. 208). If necessary, use a soft brush to remove dirt from the pores. Do not use acid, alkaline or chlorinated products that can harm the hardware of your furniture.

For extra protection we recommend Synthetics Protector (p. 208) which applies an invisible film and reduces the adhesion of dirt.

## INFORMATION

Batyline® est une fibre polyester qui est recouverte d'une couche de PVC, puis tissée. Ces fibres sont ensuite fondues ensemble pour créer une toile extrêmement résistante à la déchirure, qui conserve parfaitement sa forme. En plus de ses résistances mécaniques exceptionnelles, Batyline® possède aussi une résistance chimique élevée. La couche synthétique de PVC garantit une résistance extrême aux intempéries et UV. Comme Batyline® n'absorbe aucune humidité, il sèche très rapidement et est insensible aux taches et aux moisissures. En outre, il est très flexible, ce qui assure un grand confort d'assise.

Canatex® est une variante spéciale qui combine le Batyline® ordinaire avec la fibre naturelle de chanvre. Cette combinaison produit des coloris plus subtils et un aspect visuel et tactile naturel, mais n'affecte en rien les avantages technologiques du produit.

## ENTRETIEN

Batyline® est très facile à entretenir et peut être nettoyé simplement avec de l'eau pure et un détergent liquide à pH neutre. Les taches récalcitrantes peuvent être éliminées avec le Synthetics Super Cleaner (p. 208). Si nécessaire, employez une brosse douce pour éliminer les saletés dans les pores. N'utilisez pas de produits acides, alcalins ou contenant du chlore, qui risquent d'attaquer la carcasse de votre meuble.

Pour une protection supplémentaire, nous recommandons du Synthetics Protector (p. 208) qui applique un film invisible réduisant l'incrustation de saletés.

## INFORMATIE

Batyline® is een polyestervezel die gecoat wordt met een laag PVC en daarna geweven. De vezels worden daarna samengesmolten om een extreem scheurbestendige doek te creëren die zijn vorm perfect behoudt. Naast zijn buitengewoon mechanische sterktes, heeft Batyline® ook een hoge chemische weerstand. De synthetische pvc laag garandeert een extreem hoge weer- en UV-bestendigheid. Omdat Batyline® geen vocht absorbeert, droogt het erg snel en is het vlek- en schimmelbestendig. Bovendien is het ook erg flexibel waardoor het zitcomfort erg aangenaam is.

Canatex® is een speciale variant die gewone Batyline® combineert met de natuurlijke hennepvezel. Deze combinatie geeft meer subtiele kleuren en een natuurlijke look & feel, waarbij alle technologische voordelen van het product behouden blijven.

## ONDERHOUD

Batyline® is zeer onderhoudsvriendelijk en kan makkelijk gereinigd worden met zuiver water en een pH-neutraal, vloeibaar detergent. Hardnekkige vlekken kunnen verwijderd worden met Synthetics Super Cleaner (p. 208). Gebruik indien nodig een zachte borstel om vuil uit de poriën te verwijderen. Gebruik geen zure, basische of chloorhoudende producten die de hardware van uw meubel kunnen aantasten.

Voor extra bescherming raden we Synthetics Protector (p. 208) aan die een onzichtbare film aanbrengt die de aanhechting van vuil vermindert.





### INFORMATION

In the world of metals, brass is a distinctive element that has enriched our lives for centuries. Being an alloy of copper and zinc, it is highly malleable and therefore remarkably versatile. Its frequent use in the marine industry also underlines its sustainable quality.

But one of its captivating charms is its capacity to transform over time. When encountering the elements of its surroundings like air, moisture and various environmental factors, a chemical reaction leads to the formation of a thin outer layer, known as patina.

The intrinsic qualities and warm aesthetics of the brass make it the ideal material for our beautifully crafted hardware, detailing the table top and discreetly conjoining multiple SURO dining tables.

### MAINTENANCE

Brass is easy to clean with clear, fresh water and a pH-neutral liquid detergent. Always use a soft, clean cloth. Over time, brass will develop a sophisticated patina, ranging from greens and blues to a warm brown.

Substances, especially salty and acidic ones like juice, coffee, red wine, balsamic vinegar, bird droppings and leaves, leave no stains but do influence the nuances of the brass' surface. For minimal impact, immediately wipe off all substances.

When cleaning, please avoid intense rubbing to maintain the corroded, matte appearance. Once the brass acquires a shiny glow, the only way to recover its elegantly aged appearance, is to be patient.

### INFORMATION

Dans le monde des métaux, le laiton est un élément distinctif qui embellit notre vie depuis des siècles.

Alliage de cuivre et de zinc, il est très malléable et donc hautement polyvalent. Son utilisation fréquente dans l'industrie maritime souligne en outre ses qualités durables.

Toutefois, l'un de ses charmes les plus captivants est sa capacité à se transformer au fil du temps. Au contact des éléments de son environnement, tels que l'air, l'humidité et divers facteurs environnementaux, une réaction chimique conduit à la formation d'une fine couche extérieure, appelée patine.

Les qualités intrinsèques et l'esthétique chaleureuse du laiton se prêtent parfaitement à la réalisation de notre raccord, détaillant le plateau de la table et joignant harmonieusement plusieurs tables à manger SURO.

### ENTRETIEN

Le laiton est facile à nettoyer avec de l'eau claire et un détergent liquide au pH neutre. Utilisez toujours un chiffon doux et propre.

Avec le temps, le laiton acquiert une patine sophistiquée, allant des verts et des bleus à un brun chaud. Les substances, notamment salées et acides comme le jus, le café, le vin rouge, le vinaigre balsamique, les fientes d'oiseaux et les feuilles, ne laissent pas de taches, mais altèrent les nuances de la surface du laiton. Pour limiter les effets, essuyez immédiatement toutes les substances.

Pendant le nettoyage, évitez de frotter de manière trop vigoureuse afin de conserver l'aspect corrodé et mat. Une fois que le laiton a acquis un éclat brillant, la seule façon de retrouver son aspect patiné élégant est de s'armer de patience.

### INFORMATIE

In de wereld van metalen is messing een karakteristiek element dat onze levens al eeuwenlang verrijkt. Als legering van koper en zink is het materiaal zeer vormbaar en dus opmerkelijk veelzijdig. Het frequente gebruik in de maritieme industrie onderstreept de duurzame kwaliteit ervan.

Maar zijn fascinerende charme ligt ook in het vermogen om in de loop van de tijd te transformeren. Bij contact met natuurlijke omgevingselementen zoals lucht, vocht en diverse weersomstandigheden ontstaat een chemische reactie die een dunne buitenlaag vormt, bekend als patina.

De intrinsieke kwaliteiten en warme esthetiek maken van messing het ideale materiaal voor het prachtig ontworpen beslag en discrete koppelingselement van onze SURO tafels.

### ONDERHOUD

Messing is gemakkelijk proper te maken met helder kraanwater en een vloeibaar pH-neutraal reinigingsmiddel. Gebruik altijd een zachte, zuivere doek.

Met de tijd ontwikkelt het messing een gesofisticeerd patina, gaande van groene en blauwe tinten tot een warm bruin. Substanties zoals zoute en zure sappen (koffie, rode wijn, balsamico azijn), vogeluitwerpselen en bladeren maken geen permanente vlekken, maar hebben wel een invloed op de nuances van het oppervlak. Veeg voor een minimale impact alle substanties onmiddellijk weg.

Vermijd bij reiniging intensief wrijven om het gecorrodeerde, matte uiterlijk te behouden. Zodra het messing een glans vertoont, is geduld de enige manier om het elegant verouderde patina terug te krijgen.



#### INFORMATION

Canax® is a unique combination of natural hemp and synthetic fibres. Unbreakable polyester fibres give strength and stability. PVC makes the Canax® stain repellent and resistant to outside influences, fungi, frost and UV radiation. The hemp finally, gives the material a surprisingly matte look and a natural touch, almost like leather. Canax® is also a CO2 positive product. As hemp is a natural product, differences in colour and structure may appear, giving the furniture - together with the hand weaving - a unique craft appearance, which cannot be regarded as a fault.

#### MAINTENANCE

Canax® requires hardly any maintenance and is easy to clean with clear water and a PH neutral soap. Stubborn stains and persistent green deposit can be removed with Synthetics Super Cleaner (p. 208). Use a soft brush to clean between the weave.

For extra protection we recommend Synthetics Protector (p. 208) which applies an invisible film and reduces the adhesion of dirt.

#### INFORMATION

Canax® est une combinaison unique de chanvre naturel et de fibres synthétiques. Les fibres polyester incassables garantissent la résistance et la stabilité. Le PVC rend le matériau grand-teint, résistant aux moisissures, au gel et aux taches. Enfin, le chanvre crée un aspect mat surprenant et une sensation naturelle presque comparable à celle du cuir. En outre, le Canax® est un produit CO2 positif. Comme le chanvre est un produit naturel, de légères différences de couleur et de structure peuvent apparaître. Avec le tissage manuel, elles confèrent au meuble un aspect artisanal unique, qui ne peut pas être considéré comme un défaut.

#### ENTRETIEN

Canax® est très facile à entretenir et peut être nettoyé simplement avec de l'eau pure et un détergent liquide à pH neutre. Les taches récalcitrantes peuvent être éliminées avec le Synthetics Super Cleaner (p. 208). Utilisez une brosse douce pour éliminer les saletés entre le tissage.

Pour une protection supplémentaire, nous recommandons du Synthetics Protector (p. 208) qui applique un film invisible réduisant l'incrustation de saletés.

#### INFORMATIE

Canax® is een unieke combinatie van natuurlijke hennep en kunstofvezels. Onbreekbare polystervezels zorgen voor sterkte en stabiliteit. PVC maakt het materiaal kleurvast, schimmel-, vorst- en vlekbestendig. De hennep ten slotte, zorgt voor een verrassend mat uitzicht en een natuurlijk gevoel, bijna vergelijkbaar met leder. Canax® is bovendien een CO2 positief product. Aangezien hennep een natuurlijk product is, kan er een licht verschil in kleur en structuur ontstaan. Samen met het handweven, geeft dit een uniek, artisanaal uitzicht aan het meubel dat niet aanzien kan worden als een fout.

#### ONDERHOUD

Canax® is zeer onderhoudsvriendelijk en kan makkelijk gereinigd worden met zuiver water en een pH-neutraal, vloeibaar detergent. Hardnekkige vlekken kunnen verwijderd worden met Synthetics Super Cleaner (p. 208). Gebruik een zachte borstel om vuil tussen de weving te verwijderen.

Voor extra bescherming raden we Synthetics Protector (p. 208) aan die een onzichtbare film aanbrengt die de aanhechting van vuil vermindert.





AMANU, ILLUM, NOX, OTTO, T-TABLE, TOSCA & UKIYO

---



### INFORMATION

Ceramic has been used for centuries for all kinds of purposes. With its unique characteristics it is the ideal material for outdoor table tops. Ceramic is UV-resistant, frost proof, extremely scratchproof and completely stain-repellent. The ceramic used by Tribù is coloured in the mass and guarantee years of carefree pleasure. The raw materials are selected very carefully by suppliers from Western and Southern Europe only. Every top is unique. For example, the Scisto colour may show subtle veins, but this is not the case for every top. The ceramic table tops are slightly bended so water can flow off.

### MAINTENANCE

Ceramic is very easy to maintain with clear water and a pH-neutral soap. Stubborn stains can be removed with Ceramic, Lava Stone & Glass Cleaner (p. 207). To protect the ceramic, Ceramic, Lava Stone & Glass Protector (p. 207) can be used. This applies a highly water and soiling repellent coating, which also makes the surface brighter, smoother and easier to clean.

---

### INFORMATION

La céramique est utilisée depuis des siècles dans les applications les plus diverses et constitue le matériau idéal pour les plateaux de table destinés à l'extérieur. Elle est extrêmement résistante aux taches, acides, griffes, au feu, au gel et aux rayons UV. La céramique employée par Tribù est complètement teintée dans la masse et vous garantit des années de plaisir sans le moindre souci. Les matières premières sont sélectionnées très soigneusement par des fournisseurs d'Europe Occidentale et du Sud. Chaque plateau est unique. Par exemple, sur la variante Scisto des fines veines peuvent figurer, mais ce n'est pas le cas pour chaque dessus de table. Les plateaux de table en céramique sont légèrement convexes de sorte que l'eau puisse s'en écouler.

### ENTRETIEN

La céramique est facile à entretenir avec de l'eau pure et un détergent liquide à pH neutre. Les taches récalcitrantes peuvent être éliminées avec le Ceramic, Lava Stone & Glass Cleaner (p. 207). Le Ceramic, Lava Stone & Glass Protector (p. 207) applique une couche protectrice invisible qui est hydrofuge et antitaches, et rend la surface plus claire, plus lisse et plus facile à nettoyer.

---

### INFORMATIE

Keramiek wordt al eeuwenlang gebruikt voor allerlei doeleinden en is het ideale materiaal voor tafelbladen voor buitengebruik. Het is uiterst bestand tegen vlekken, zuren, krassen, vuur, vorst en UV-stralen. De keramiek die Tribù gebruikt, is volledig in de massa gekleurd en garandeert u jarenlang plezier zonder zorgen. De selectie van de grondstoffen gebeurt uiterst zorgvuldig door enkel West- en Zuideuropese leveranciers waarbij elk blad uniek is. De Scisto variant kan bijvoorbeeld subtiele aders vertonen, maar dit is niet voor elk blad het geval. Onze keramische tafelbladen zijn lichtjes gebogen zodat het water eraf kan vloeien.

### ONDERHOUD

Keramiek is eenvoudig te onderhouden met zuiver water en een pH-neturaal, vloeibaar detergent. Hardnekkige vlekken kunnen verwijderd worden met Ceramic, Lava Stone & Glass Cleaner (p. 207). Ceramic, Lava Stone & Glass Protector (p. 207) brengt een onzichtbare bescherm laag aan die waterafstotend en vlekwerend werkt en het oppervlak helderder, gladder en makkelijker om te reinigen maakt.



**INFORMATION**

The durability and strength of tempered glass make it an excellent choice for any outdoor application. Being coloured throughout, the glass's hue remains vibrant and consistent, even with prolonged outdoor exposure. Each panel features polished edges, providing a refined finish that is also child-friendly. The unique texture of the surface diffuses and scatters light in a playful manner, resulting in an elegant visual effect.

**MAINTENANCE**

Glass surfaces are easy to clean with pure water or a glass cleaner and a microfibre cloth, preferably when the glass has cooled. On the textured surface, deposits and dirt may remain. Wipe these away with a microfibre cloth as quickly as possible, ensuring you cover the entire surface and edges. For stubborn stains, use our Glass, Ceramic & Lava Stone Cleaner (p. 207). Abrasive cleaners are strongly discouraged. Glass is not impervious and may develop micro-scratches over time due to ageing.

The Glass, Ceramic & Lava Stone Protector (p. 207) protects the glass surface against water rings and the adherence of stubborn dirt, slows the natural ageing of the material, and facilitates effortless cleaning.

Do not place pottery or cement-based vases or pots on the glass, as they may damage the surface upon contact with water. Always use a coaster for ceramic or porcelain plates, pots, and cutlery. Avoid placing hot pots and candles directly on the glass or use an insulating coaster.

**INFORMATION**

La durabilité et la solidité du verre trempé en font un excellent choix pour toute application extérieure. Grâce à la coloration dans la masse, le verre reste vif et d'une couleur constante lors d'une utilisation prolongée à l'extérieur. Chaque panneau est doté de bords polis, une finition esthétiquement attrayante qui est également conviviale pour les enfants. La texture unique de la surface diffuse et réfracte la lumière de manière ludique, produisant un effet visuel élégant.

**ENTRETIEN**

Les panneaux en verre sont faciles à nettoyer avec de l'eau pure ou un nettoyant pour vitres et un chiffon en microfibre, de préférence lorsque le verre a refroidi. Sur la surface texturée, des dépôts et de la saleté peuvent rester – essuyez-les dès que possible avec un chiffon en microfibre jusqu'au bord complet. Pour les taches tenaces, utilisez notre Nettoyant pour Verre, Céramique et Pierre de Lave (p. 207). Les abrasifs sont fortement déconseillés. Le verre n'est pas invulnérable et peut montrer des micro-dommages avec le temps.

Le Protecteur pour Verre, Céramique et Pierre de Lave (p. 207) protège la surface en verre contre les anneaux d'eau et l'adhérence des saletés tenaces, ralentit le vieillissement naturel du matériau et facilite le nettoyage.

Ne placez pas de vases ou de pots en terre cuite ou en ciment sur le verre, car ils peuvent endommager la surface au contact de l'eau. Utilisez toujours un dessous-de-plat pour les assiettes, pots et couverts en céramique ou en porcelaine. Évitez les pots chauds et les bougies ou utilisez un dessous isolant.

**INFORMATIE**

De duurzaamheid en sterkte van gehard glas maken het een uitstekende keuze voor elke buitentoepassing. Door de kleuring in de massa blijft het glas levendig en consistent van kleur bij langdurig gebruik buiten. Elk blad is voorzien van gepolijste randen, een esthetisch aantrekkelijke afwerking die ook kindvriendelijk is. De unieke textuur van het oppervlak breekt en verspreidt het licht op een speelse manier, met een elegant visueel effect als resultaat.

**ONDERHOUD**

Glazen bladen zijn eenvoudig te reinigen met zuiver water of een ruitenreiniger en een microvezeldoek, bij voorkeur wanneer het glas is afgekoeld. Op het gestructureerde oppervlak kunnen neerslag en vervuiling achterblijven – neem deze zo snel mogelijk af met een microvezeldoek tot over de volledige rand. Gebruik voor hardnekkige vlekken onze Glass, Ceramic & Lava Stone Cleaner (p. 207). Schuurmiddelen zijn sterk afgeraden. Glas is niet onaantastbaar en kan door veroudering microbeschadigingen vertonen.

De Glass, Ceramic & Lava Stone Protector (p. 207) beschermt het glazen blad tegen wateringen en de aanhechting van hardnekkig vuil, vertraagt de natuurlijke veroudering van het materiaal en vergemakkelijkt eenvoudig reinigen.

Plaats geen aardewerk of cementgebonden vazen of potten op het glas, omdat deze schade aan het oppervlak kunnen veroorzaken bij contact met water. Gebruik altijd een onderlegger bij keramische of porseleinen borden, potten en bestek. Vermijd hete potten en kaarsen of gebruik een isolerende onderzetter.

# GLAZED LAVA STONE

PIERRE DE LAVE ÉMAILLÉE - GEGLAZUURDE LAVASTEEN

---

HEXAGON, NOX, SENJA, TAIRU & T-TABLE

---

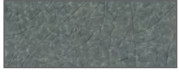

## INFORMATION

Glazed lava is a unique and handcrafted material that expresses the natural aspect of lava stone. It offers the inherent strength of the volcanic stone combined with all the surface qualities associated with enamels. The density of the lava rock stone allows it to be used in one large piece. Once molten lava, the stone can withstand the very high temperatures used in the glazing process. Glazing makes sure the finished product is UV stable, impervious to water and resistant to heat, frost, chemicals and stains. It is very easy to maintain. Tribù chose for a subtle craquelé effect. As it is a natural product, you will find "aesthetic imperfections" that are just peculiar characteristic of both natural stone and handcrafted finishing. No table top in glazed lava stone will therefore be the same, making it so unique and attractive.

## MAINTENANCE

Glazed lava stone is easy to maintain with clean water and a pH neutral liquid detergent. Possible stains can be removed with Ceramic, Lava Stone & Glass Cleaner (p. 207). To protect the surface we recommend Ceramic, Lava Stone & Glass Protector (p. 207) which fills the micro pores so dirt particles won't attach to the surface and will be rain-washed.

---

## INFORMATION

La pierre de lave émaillée est un matériau unique et artisanal qui souligne de superbe manière l'aspect naturel de la pierre de lave. Elle allie la robustesse de la pierre de lave et les avantages de l'émail.

Grâce à la haute densité de la pierre de lave, elle peut être utilisée en grands morceaux. Originellement de la lave en fusion, la pierre est donc parfaitement adaptée pour supporter les températures élevées du processus d'émaillage. La couche d'émail permet au matériau de résister à l'eau, au gel, à la chaleur, aux taches et aux rayons UV. Par ailleurs, elle offre une résistance élevée aux produits chimiques et ne nécessite presque aucun entretien.

Tribù a opté pour un subtil effet craquelé. Comme il s'agit d'un matériau naturel, il peut présenter quelques « imperfections esthétiques ». Dès lors, il n'existe pas deux tablettes en pierre de lave émaillée qui soient totalement identiques. Et tout ce qui est unique attire.

## ENTRETIEN

La pierre de lave émaillée se nettoie facilement à l'eau, avec un détergent liquide au pH neutre. Pour éliminer les taches éventuelles, il convient d'employer du Ceramic, Lava Stone & Glass Cleaner (p. 207). En guise de protection, nous recommandons Ceramic, Lava Stone & Glass Protector (p. 207), un produit qui bouche les micropores du matériau, de sorte que la saleté ne peut s'accrocher à la surface et sera éliminée par la pluie.

---

## INFORMATIE

Geglazuurde lavasteen is een uniek en ambachtelijk bewerkt materiaal dat het natuurlijke aspect van lavasteen op een prachtige manier benadrukt. Het combineert de sterkte van lavasteen met de voordelen van glazuren. Dankzij de hoge densiteit van lavasteen kan het in grote stukken gebruikt worden. Omdat het ooit gesmolten lava was, kan de steen perfect de hoge temperaturen nodig tijdens het glazuurproces weerstaan. De glazuurlaag zorgt ervoor dat het materiaal erg water-, vorst-, hitte-, vlek- en UV bestendig is. Het heeft een hoge weerstand tegen chemicaliën en vergt bijna geen onderhoud.

Tribù koos voor een subtiel craquelé effect. Omdat het een natuurlijk product is, zijn 'esthetische imperfecties' eigen aan het materiaal. Geen enkel tafelblad in geglazuurde lavasteen zal dus hetzelfde zijn. Net dat maakt het zo uniek en aantrekkelijk.

## ONDERHOUD

Geglazuurde lavasteen is eenvoudig te reinigen met zuiver water en een pH neutraal, vloeibaar detergent. Eventuele vlekken kunnen verwijderd worden met Ceramic, Lava Stone & Glass Cleaner (p. 207). Als bescherming raden we Ceramic, Lava Stone & Glass Protector (p. 207) aan. Dit product vult de microporiën van het materiaal waardoor vervuiling zich niet kan hechten aan het oppervlak en door een gewone regenbui weg gewassen zal worden.





#### INFORMATION

Granite is an igneous rock that is formed deep below the earth's surface by compression. Because the pressure below the Earth's surface is so high, granite is immensely hard. After diamond, it is the strongest rock species on earth. Granite is little porous and has good scratch resistance. Germs and fungi have no chance. The name granite comes from the Latin 'granus', which means 'grain'. This 'granular' look is typical of granite. No two table tops will be ever alike. Tribù granite table tops have a 'leather touch' finish. This soft, brushed finish accentuates the natural colour of the material and gives a unique, soft touch.

#### MAINTENANCE

Granite can be cleaned with water and pH neutral soap. Granite Cleaner/Protector (p. 209) refreshes the gloss of the granite and makes it water and stain repellent. Do not use aggressive detergents as they attack the lime in the stone.

#### INFORMATION

Le granite est une roche magmatique formée profondément sous la surface de la terre par compression. Comme la pression à cette profondeur est tellement élevée, le granite est exceptionnellement dur. Après le diamant, c'est le type de roche le plus dur sur terre. Le granite est peu poreux et présente une bonne résistance aux rayures. Les bactéries et moisissures n'y ont aucune chance. Granite vient du latin « granus », qui signifie « grain ». Cet aspect « granulaire » est typique pour le granite. Il n'y a jamais deux plateaux de table identiques. Les plateaux de table en granite de Tribù présentent une finition « leather touch ». Cette finition brossée douce accentue la couleur naturelle du matériau et donne une sensation unique et douce au toucher.

#### ENTRETIEN

Le granite peut être nettoyé avec de l'eau pure et un savon à pH neutre. Granite Cleaner/Protector (p. 209) rafraîchit également le brillant du granite, et le rend résistant à l'eau et aux taches. N'employez pas de détergents agressifs étant donné que ceux-ci peuvent attaquer le calcaire dans la pierre.

#### INFORMATIE

Graniet is een stollingsgesteente dat diep onder het aardoppervlak wordt gevormd door compressie. Omdat de druk onder het aardoppervlak zo hoog is, is graniet ontzettend hard. Na diamant is het de sterkste steensoort op aarde. Graniet is weinig poreus en heeft een goede krasbestendigheid. Bacteriën en schimmels maken geen kans. Graniet komt van het Latijnse 'granus', wat 'korrel' betekent. Deze 'granulaire' look is typisch voor graniet. Geen twee tafelbladen zullen ooit gelijk zijn.

#### ONDERHOUD

Graniet kan gereinigd worden met zuiver water en pH neutrale zeep. Granite Cleaner/Protector (p. 209) frist de glans van het graniet op en maakt het water- en vlekafstotend. Gebruik geen agressieve detergents aangezien ze de kalk in de steen kunnen aantasten.



## INFORMATION

Our tables in lightened concrete do not contain gravel, like ordinary concrete, but a mix of quartz granulates and fibres, making the material a lot lighter. Nevertheless, it is very sturdy\* and durable. Frost and heat have no influence and the colouring in the mass ensures that your table will retain its original colour for a long time. Each furniture piece is hand-finished by an Italian craftsman, giving it a unique patina and a smooth surface texture.



However, lightened concrete is a natural product and sensitive to stains. Despite the fact that we treat our tables with a concrete conditioner that reduces stains and moisture absorption, some caution is required, as with natural stone and marble.

\*We recommend a maximum load of 10 kg on the coffee table tops.

## MAINTENANCE

For daily cleaning, dip a soft, clean cloth in a solution of warm, clear water and a pH-neutral fluid detergent. Rinse thoroughly and let dry. Stains should be wiped off immediately, especially acidic substances (juice, coffee, red wine, balsamic vinegar,...) since they may cause permanent stains. Also bird droppings and leaves may cause permanent stains if not removed immediately. We recommend to use a protective cover if you are not using your table.

Oil, grease and wax stains can be removed by using Tribù Oil, Wax and Grease Remover (p. 210). Do not use corrosive or acidic detergents.

To protect your table, we recommend to use Tribù Lightened Concrete Conditioner (p. 210) regularly. However, this product does not protect against acidic substances. It can also be used for removing stains. Depending on the type of stain and its age, the stain can be completely removed or its intensity reduced.

Lightened concrete contains natural fibers that can surface over time due to temperature fluctuations, which could feel slightly unpleasant to the touch. If this happens, we recommend to lightly hand sand the table top with a sanding disc making circular movements until the surface feels smooth again.



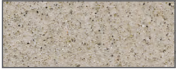

### INFORMATION

Nos plateaux de table en béton allégé ne contiennent pas de gravier comme le béton ordinaire, mais un mélange de granulés de quartz et de fibres qui rendent le matériau beaucoup plus léger. Le béton allégé est néanmoins un matériau très solide\* et durable. Il est insensible au gel et à la chaleur et, comme il est coloré dans la masse, votre table conservera longtemps sa couleur d'origine. Chaque pièce est finie à la main par un artisan italien, ce qui lui confère une patine unique et une texture de surface lisse.

Le béton allégé est toutefois un produit naturel et sensible aux taches. Malgré le fait que nous prévoyons un produit de conditionnement pour le béton limitant les taches et l'absorption d'humidité, une certaine prudence est de mise, comme avec la pierre naturelle et le marbre.

\* La charge maximale des plateaux de tables basses est de 10 kg.

### ENTRETIEN

Pour le nettoyage quotidien, plongez un chiffon propre dans une solution d'eau chaude et un détergent liquide au pH neutre. Rincez abondamment et laissez sécher. Des taches doivent être essuyées immédiatement, en particulier les substances acides (jus, café, vin rouge, vinaigre balsamique,...) car elles peuvent provoquer des taches permanentes. Les fientes d'oiseaux et les feuilles peuvent également provoquer des taches permanentes si elles ne sont pas enlevées immédiatement. Nous vous recommandons d'utiliser une housse de protection si vous n'utilisez pas votre table.

Les taches d'huile, de graisse et de cire peuvent être enlevées à l'aide du Tribù Oil, Wax and Grease Remover (p. 210). N'utilisez pas de détergents corrosifs ou acides.

Pour protéger votre table, nous vous recommandons d'utiliser régulièrement du Tribù Lightened Concrete Conditioner (p. 210). Cependant, ce produit ne protège pas contre les substances acides. Il peut également être utilisé pour éliminer les taches. Selon le type de tache et son âge, la tache peut être complètement éliminée ou son intensité réduite.

Le béton allégé contient des fibres naturelles qui pourraient remonter à la surface sous l'effet des changements de température, ce qui peut provoquer une sensation désagréable. Dans ce cas, vous pouvez utiliser un disque de ponçage pour poncer le plateau de table légèrement à la main, en effectuant des mouvements circulaires, jusqu'à ce qu'il soit à nouveau lisse.

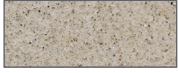

### INFORMATIE

Onze tafels uit verlicht beton bevatten geen grind zoals gewoon beton, maar een mix van kwartsgranulaten en vezels waardoor het materiaal een stuk lichter is. Desalniettemin is het zeer stevig\* en duurzaam. Vorst en hitte hebben geen invloed en de kleuring in de massa zorgt ervoor dat uw tafel langdurig haar originele kleur zal behouden. Elk stuk wordt met de hand afgewerkt door een Italiaanse vakman, waardoor het een unieke patina en een gladde oppervlaktetextuur krijgt.



Verlicht beton is echter een natuurlijk product en gevoelig voor vlekken. Ondanks het feit dat wij onze tafels voorzien van een betonconditioner die vlekken en vochtopname beperkt, is enige voorzichtigheid geboden, zoals bij natuursteen en marmer.

\*Maximale belasting van de tafelbladen van lage salontafels is 10kg.

### ONDERHOUD

Dompel voor de dagelijkse reiniging een zachte, propere doek onder in een oplossing van warm, zuiver water en een pH-neutraal vloeibaar reinigingsmiddel. Spoel grondig af en laat drogen. Vlekken dienen onmiddellijk worden afgeveegd, vooral zure stoffen (sap, koffie, rode wijn, balsamico azijn,...) daar ze permanente vlekken kunnen veroorzaken. Ook vogeluitwerpselen en bladeren kunnen permanente vlekken veroorzaken als ze niet onmiddellijk worden verwijderd. We raden u aan een beschermhoes te gebruiken als u uw tafel niet gebruikt.

Olie-, vet- en kaarsvetvlekken kunnen worden verwijderd met Tribù Oil, Wax & Grease Remover (p. 210).

Gebruik geen bijtende of zure reinigingsmiddelen.

Om uw tafel te beschermen, raden wij u aan om regelmatig Tribù Lightened Concrete Conditioner (p. 210) te gebruiken. Dit product beschermt echter niet tegen zure stoffen. Het kan ook gebruikt worden voor het verwijderen van vlekken. Afhankelijk van het soort vlek en de leeftijd kan de vlek volledig worden verwijderd of de intensiteit ervan worden verminderd.

Verlicht beton bevat natuurlijke vezels die onder invloed van temperatuurschommelingen aan de oppervlakte kunnen komen, wat een onaangenaam gevoel kan veroorzaken. In dat geval raden wij aan het blad met de hand licht cirkelvormig op te schuren met een schuurschijfje tot het oppervlak weer glad aanvoelt.



# MONSIEUR TRICOT

## OUTDOOR LAMPS

---



### INFORMATION

The Monsieur Tricot outdoor lamps are made of a sphere in PMMA thermoplastic with a removable hand crocheted or knitted polypropylene cover.

#### Standing lamps

- Lamp
  - Dimmable LED, 9-12.6 Volt, Kelvin 2.129
  - 12 hours operational when burning at 100%
- Charging
  - Rechargeable battery
  - Power adaptor with USB-slot, cable included
  - 5 hours of charging time
- Control
  - On/off switch
- Extra
  - Ceiling hook included to turn your standing lamp into a hanging version

#### Hanging lamps

- Lamp
  - E27/E26 fitting with dimmable LED filament bulb included, Kelvin 2200
  - Connect to local power grid, 220-240 volt.
  - 5 meter cable, mounting bracket, ceiling canopy and wire connector clamps included
  - Please contact a local professional to install a hanging Monsieur Tricot lamp
- Control
  - Use an already available switch or have a local professional install a new switch. Switches cannot be purchased from Tribù

#### Certificates

- CE (EU + UK), RoHS 2.0 (EU), FCC (USA), IC (Canada), SAA (Australia & New Zealand), RCM (Australia & New Zealand, only for standing lamps), MOC (Israel)
- IK08
- IP65

#### MAINTENANCE

The knitted cover can easily be removed to be cleaned in a washing machine at 40° (synthetic washing program). Let dry in open air, certainly not in the dryer. Extend the Lebonnet braiding well before drying. Stubborn stains can be removed with Synthetics Super Cleaner (p. 208). Use a microfiber cleaning cloth to clean the lamp. Do not use a scourer, this causes scratches and damages the surface.



### INFORMATION

Les lampes d'extérieur de Monsieur Tricot sont composées d'une sphère en thermoplastique PMMA avec une housse removable en polypropylène croché à la main ou tricotée.

#### Lampes sur pied

- Lampe
  - Lampe LED dimmable, 9-12.6 Volt, Kelvin 2.129
  - Autonomie 12 heures lorsque le dimmer est à 100 %
- Chargement
  - Batterie rechargeable
  - Chargeur avec port USB, câble inclus
  - 5 heures de chargement
- Contrôle
  - Bouton on/off
- Extra
  - Crochet de plafond inclus pour transformer votre lampe sur pied en une version suspendue

#### Lampes à suspendre

- Lampe
  - Douille E27/E26 avec ampoule à incandescence LED incluse, Kelvin 2200.
  - Connexion sur le réseau électrique, 220-230 V
  - Câble de 5 mètres, support de montage, auvent de plafond et pinces de connexion de fil inclus
  - Prenez contact avec un professionnel local pour installer les lampes.
- Mise en fonction
  - Utilisez une prise de la maison (ou demandez à un professionnel local d'installer une nouvelle). Les prises ne sont pas fournies par Tribù.

#### Certificats

- CE (UE + UK), RoHS 2.0 (UE), FCC (USA), IC (Canada), SAA (Australie & Nouvelle-Zélande), RCM (Australie & Nouvelle-Zélande, uniquement pour les lampes sur pied), MOC (Israël)
- IK08
- IP65

#### ENTRETIEN

La housse crochée peut être retirée facilement pour être nettoyée en machine à 40°C (programme synthétique). Laissez-la sécher à l'air, jamais au sèche-linge. Étirez bien le tricot Lebonnet avant de le mettre à sécher. Les taches récalcitrantes peuvent être éliminées avec Synthetics Super Cleaner (p. 208). Utilisez un chiffon en microfibre pour nettoyer la lampe. N'utilisez pas d'éponge à récurer, qui laisse des rayures et endommage la surface.





#### INFORMATIE

De buitenbestendige lampen van Monsieur Tricot (voor bestaan uit een bol in PMMA kunststof met een verwijderbare handgehaakte of gebreide hoes uit polypropyleen.

#### Staanlampen

- Lamp
  - dimbare LED lamp, 9-12.6 Volt, Kelvin 2.129
  - brandt gedurende 12 uur indien de dimmer op 100% staat
- Opladen
  - Herlaadbare batterij
  - Voedingsadapter met USB-aansluiting, kabel inbegrepen
  - 5 uur oplaadtijd
- Besturing
  - Aan/uit schakelaar
- Extra
  - Inclusief plafondhaak om uw staande lamp om te vormen in een hanglamp

#### Hanglampen

- Lamp
  - E27/E26 fitting met dimbare LED-gloeilamp inbegrepen, Kelvin 2200
  - Aansluiten op het elektriciteitsnet, 220-240 volt.
  - 5 meter kabel, montagebeugel, plafondkap en draadaansluitklemmen inbegrepen
  - Neem contact op met een plaatselijke professional om een hangende Monsieur Tricot-lamp te installeren
- Besturing
  - Gebruik een reeds beschikbare schakelaar of laat een lokale professional een nieuwe schakelaar installeren. Schakelaars kunnen niet worden gekocht bij Tribù.

#### Certificaten

- CE (EU + UK), RoHS 2.0 (EU), FCC (VS), IC (Canada), SAA (Australië & Nieuw-Zeeland), RCM (Australië & Nieuw-Zeeland, enkel voor staanlampen), MOC (Israël).
- IK08
- IP65

#### ONDERHOUD

De gehaakte hoes kan eenvoudig worden verwijderd om te worden gereinigd in de wasmachine op 40° (synthetisch wasprogramma). Laten drogen in de lucht, zeker niet in de droogkast. Trek het Lebonnet-breiwerk goed uit voordat u het te drogen legt. Hardnekkige vlekken kunnen worden verwijderd met Synthetics Super Cleaner (p. 208). Gebruik een microvezeldoekje om de lampvorm te reinigen. Gebruik geen schuurspons, dit veroorzaakt krassen en beschadigt het oppervlak.



### INFORMATION

Tribù outdoor rugs are the only outdoor rugs on the market that are made of 100% solution dyed PVC coated polyester. This gives them not only an excellent UV resistance - they are also very easy to clean because the yarns do not absorb water. They dry quickly and are stain repellent. All rugs are hand woven which results in an artisanal look and makes each rug unique.

### MAINTENANCE

Vacuum the rug regularly to remove loose dirt. Clean with a garden hose or even a high pressure cleaner. Stubborn stains can be removed with Synthetics Super Cleaner (p. 208). To protect the rug against stains, Synthetics Protector (p. 208) can be used which applies an invisible film.

---

### INFORMATION

Les tapis d'extérieur de Tribù sont les seuls tapis sur le marché fabriqués par 100% en polyester enduit de PVC teinté dans la masse. Cela leur confère non seulement une excellente résistance aux UV, mais les rend très faciles à nettoyer parce que les fibres n'absorbent pas d'eau. Ils sèchent rapidement et sont antitaches. Tous les tapis sont tissés à la main, ce qui produit un aspect artisanal et rend chaque tapis unique.

### ENTRETIEN

Aspirez régulièrement le tapis pour éliminer les saletés superficielles. Nettoyez avec un flexible d'arrosage ou même un nettoyeur haute pression. Les taches récalcitrantes peuvent être éliminées avec Synthetics Super Cleaner (p. 208). Pour protéger le tapis contre les taches, vous pouvez appliquer Synthetics Protector (p. 208), qui applique un film invisible antisalissures.

---

### INFORMATIE

De buitentapijten van Tribù zijn de enige buitentapijten op de markt die 100% gemaakt zijn van polyester gecoat met in de massa gekleurde PVC. Dit geeft hen niet alleen een uitstekende UV-bestendigheid - ze zijn ook zeer gemakkelijk te reinigen omdat de vezels geen water absorberen. Ze drogen snel en zijn vlekafstotend. Alle tapijten worden met de hand geweven wat resulteert in een ambachtelijk uitzicht en elk tapijt uniek maakt.

### ONDERHOUD

Stofzuig het tapijt regelmatig om los vuil te verwijderen. Reinig met een tuinslang of zelfs een hogedrukreiniger. Hardnekkige vlekken kunnen verwijderd worden met Synthetics Super Cleaner (p. 208). Om het tapijt te beschermen tegen vlekken, kan Synthetics Protector (p. 208) gebruikt worden dat een onzichtbare, vuilafstotende film aanbrengt.



# POWDERCOATED STAINLESS STEEL

INOX LAQUÉ - GEPOEDERLAKT INOX

CTR, NODI, NOX, TOSCA & T-TABLE

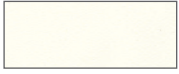

## INFORMATION

Stainless steel is an iron alloy in which the resistance to corrosion is increased by the addition of chrome, molybdenum and nickel. When exposed to air, a chromium oxide skin is formed spontaneously that protects the metal against rust. By powdercoating stainless steel, you can increase its corrosion resistance to the same level as that of aluminium. For its powdercoated stainless steel furniture Tribù uses 304L stainless steel that is ceramic blasted before it is powdercoated. Tribù always uses European, ultra-durable and scratch-resistant polyester powdercoating that guarantee a UV-resistance of 15 years.



## MAINTENANCE

Powdercoated stainless steel is easy to clean with clear water and a pH-neutral fluid detergent. Stubborn stains can be removed with Coated aluminium & stainless steel Cleaner (p. 206). If necessary, use a soft brush to remove the dirt from the pores. To protect the frame against the adhesion of dirt and to reduce fingerprints, Coated aluminium & stainless steel Protector (p. 206) can be used which applies an invisible protective film.

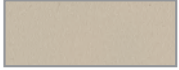

## INFORMATION

L'acier inoxydable ou « inox » est un alliage de fer dont la résistance à la corrosion a été améliorée par l'adjonction de chrome, de molybdène et de nickel. En cas d'exposition à l'air, il se forme spontanément une pellicule d'oxyde de chrome qui protège contre la rouille. Le laquage par poudre de l'inox accroît sa résistance à la corrosion jusqu'au niveau de celle de l'aluminium. Pour l'acier inox revêtu de laque en poudre, Tribù utilise l'inox 304L, qui subit un grenailage céramique avant l'application du laquage en poudre. Tribù utilise toujours des laques polyester en poudre européennes ultra durables, avec une résistance aux UV de 15 ans.

## ENTRETIEN

L'acier inoxydable revêtu de laque en poudre est facile à entretenir avec de l'eau pure et un détergent liquide à pH neutre. Vous pouvez éliminer les taches récalcitrantes avec de l'Coated aluminium & stainless steel Cleaner (p. 206). Si nécessaire, employez une brosse douce pour éliminer les saletés dans les pores. Pour protéger le cadre contre l'incrustation de saletés, on peut employer Coated aluminium & stainless steel Protector (p. 206), qui applique une couche de protection invisible.

## INFORMATIE

Roestvast staal of inox is een ijzerlegering waarvan de corrosiebestendigheid verhoogd wordt door de toevoeging van chroom, molybdenum en nikkel. Bij blootstelling aan lucht wordt spontaan een chroomoxidehuid gevormd, die tegen roest beschermt. Door inox te poederlakken wordt de corrosiebestendigheid tot het niveau van dat van aluminium verhoogd. Voor gepoederlakt roestvast staal gebruikt Tribù 304L inox, dat keramisch gepareelstraald wordt vóór het poederlakken. Tribù gebruikt steeds ultra-durable Europese krasbestendige polyesterpoederlakken met een UV-bestendigheid van 15 jaar.

## ONDERHOUD

Gepoederlakt roestvast staal is makkelijk te onderhouden met zuiver water en een pH-neutraal, vloeibaar detergent. Hardnekkige vlekken kan u verwijderen met Coated aluminium & stainless steel Cleaner (p. 206). Gebruik indien nodig een zachte borstel om vuil uit de poriën te verwijderen. Om het frame te beschermen tegen vasthechten van vuil, kan Coated aluminium & stainless steel Protector (p. 206) gebruikt worden dat een onzichtbare beschermlaag aanbrengt.

GOBI



## INFORMATION

Illia Eckhard's goal was to uncover the true essence of the basket. He created Gobi after conducting an in-depth study of skill and artisanship, which we believe are the most authentic expressions of people's humanity and creativity. The beauty of the Gobi basket makes it a stellar example of Belgian dexterity and artisanship. Each one is made by skilled artisans using traditional weaving techniques.

The ropes are made from recycled plastic bottles, with an outer layer of recycled acrylic. The result is a unique product every time, with slight differences in colour and shape.

To maintain the original look and feel of your Gobi baskets, we recommend not leaving them out in the rain, as they take a long time to dry out. If your baskets do get wet, it's best to leave them to dry out fully in the open air, allowing all the moisture to evaporate. We have decided not to produce protective covers, as we believe it's better to bring the baskets indoors when it rains.

## MAINTENANCE

Our synthetic furniture pieces are easy to maintain with clear water and a pH neutral soap. Stubborn stains can be removed with Synthetics Super Cleaner (p. 208). If necessary, use a soft brush to remove dirt from the pores. For extra protection we recommend Synthetics Protector (p. 208) which apply an invisible film and reduces the adhesion of dirt.

## INFORMATION

Illia Eckhard s'est efforcé de retrouver l'essence du panier. Au terme d'une recherche esthétique autour du travail manuel et de l'artisanat, il a créé Gobi. Nous croyons qu'il représente l'expression la plus authentique de l'humanité et de la créativité. Le savoir-faire manuel et l'artisanat belges sont incarnés dans la beauté de ce produit. Chaque panier GOBI a été confectionné par un maître-artisan mettant en œuvre des techniques de vannerie traditionnelles.

La couche externe des cordes est en acrylique recyclé tandis que leur âme est fabriquée à partir de bouteilles en plastique recyclées. Chaque article est unique car il varie légèrement en termes de couleur et de forme.

Pour que les paniers Gobi conservent leur look-and-feel, nous vous recommandons de ne pas les laisser dehors sous la pluie. S'ils sont mouillés, il leur faut longtemps pour sécher. Il est recommandé de les laisser sécher complètement à l'air libre. Nous avons décidé de ne pas proposer de protections car nous pensons qu'il vaut mieux les rentrer en cas de pluie.

## ENTRETIEN

Le synthétique s'entretient aisément avec de l'eau pure et un détergent liquide à pH neutre. Les taches récalcitrantes peuvent être éliminées avec le Synthetic Super Cleaner (p. 208). Si nécessaire, employez une brosse douce pour éliminer les saletés dans les pores. Pour une protection supplémentaire, nous recommandons du Synthetics Protector (p. 208) qui appliquent un film invisible réduisant l'incrustation de saletés.

## INFORMATIE

Illia Eckhard ging op zoek naar de ware essentie van de mand. Hij creëerde Gobi na een diepgaande studie van handwerk en vakmanschap, volgens ons de meest authentieke uiting van menselijkheid en creativiteit. De schoonheid van de Gobi-mand is een prachtig voorbeeld van Belgische technische vaardigheid en vakmanschap. Elk exemplaar is gemaakt door bekwame ambachtslieden met traditionele weeftechnieken.

De touwen zijn gemaakt van gerecycleerde petflessen, met een buitenlaag van gerecycleerd acryl. Het resultaat is telkens een uniek product, met kleine verschillen in kleur en vorm.

Om de originele look en feel van uw Gobi-manden te behouden, raden we u aan ze niet in de regen te laten staan, want het duurt lang voor ze drogen. Als uw manden nat worden, kunt u ze het best in de open lucht volledig laten drogen, zodat al het vocht kan verdampen. We hebben ervoor gekozen geen covers te maken omdat we het beter vinden dat u de manden binnen zet als het regent.

## ONDERHOUD

Kunststof is eenvoudig te reinigen met zuiver water en een pH neutraal detergent. Hardnekkige vlekken kunnen verwijderd worden met Synthetics Super Cleaner (p. 208). Gebruik indien nodig een zachte borstel om vuil uit de poriën te verwijderen. Voor extra bescherming raden we Synthetics Protector (p. 208) aan die een onzichtbare film aanbrengen die de aanhechting van vuil vermindert.



**INFORMATION**

Tribù only uses high grade virgin polypropylene compound for the production of the Vintage and Branch collection. The mass dyed PP is made anti-static, anti-fungal, frost resistant and stain repellent by the addition of additives. Also, contact with salt or chlorine water causes no problems. A very high percentage of UV stabilizing additives guarantees extremely high colour fastness, even after a long exposure to sunlight. Sharp objects should be avoided as they may cause scratches.

**MAINTENANCE**

Our synthetic furniture pieces are easy to maintain with clear water and a pH neutral soap. Stubborn stains can be removed with Synthetics Super Cleaner (p. 208). If necessary, use a soft brush to remove dirt from the pores. For extra protection we recommend Synthetics Protector (p. 208) or Coated aluminium & stainless steel Protector (p. 206) which apply an invisible film and reduces the adhesion of dirt.

**INFORMATION**

Pour les collections contenant des matières synthétiques, Tribù emploie exclusivement des composants de haute qualité avec polypropylène pur. Le PP teinté dans la masse est rendu antistatique, antimoisissures, résistant au gel et aux taches par l'adjonction d'additifs. Le contact avec l'eau saline ou chlorée ne provoque pas de problèmes non plus. Un pourcentage très élevé d'additifs de stabilisation UV garantit une tenue très élevée des couleurs, même après une longue exposition au soleil. Il faut éviter les objets tranchants, qui risquent provoquer des rayures.

**ENTRETIEN**

Le synthétique s'entretient aisément avec de l'eau pure et un détergent liquide à pH neutre. Les taches récalcitrantes peuvent être éliminées avec le Synthetic Super Cleaner (p. 208). Si nécessaire, employez une brosse douce pour éliminer les saletés dans les pores. Pour une protection supplémentaire, nous recommandons du Synthetics Protector (p. 208) ou Coated aluminium & stainless steel Protector (p. 206), qui appliquent un film invisible réduisant l'incrustation de saletés.

**INFORMATIE**

Tribù gebruikt enkel hoogwaardige, zuivere polypropyleen samenstellingen voor de collecties die kunststof bevatten. De in de massa gekleurde PP is anti-statisch, anti-schimmel, vorst- en vlekbestendig gemaakt door de toevoeging van additieven. Ook contact met zout of chloor water veroorzaakt geen problemen. Een zeer hoog percentage UV-stabiliserende additieven garandeert een extreem hoge kleurvastheid, zelfs na een lange blootstelling aan zonlicht. Scherpe voorwerpen dienen vermeden te worden aangezien ze krassen kunnen veroorzaken.

**ONDERHOUD**

Kunststof is eenvoudig te reinigen met zuiver water en een pH neutraal detergent. Hardnekkige vlekken kunnen verwijderd worden met Synthetics Super Cleaner (p. 208). Gebruik indien nodig een zachte borstel om vuil uit de poriën te verwijderen. Voor extra bescherming raden we Synthetics Protector (p. 208) of Coated aluminium & stainless steel Protector (p. 206) aan die een onzichtbare film aanbrengen die de aanhechting van vuil vermindert.

---

AMANU, DUNES, ELIO, HEXAGON, ILLUM, KOS, MOOD, NOMAD, PAVILION, PURE SOFA, ROOTS, SENJA, OTTO, TAIRU, T-TABLE, UKIYO & VIS À VIS

---



### INFORMATION

Because Tribù makes no concessions when it comes to quality, we only use carefully selected, fully grown teak, which is harvested in accordance with the strictest environmental standards from the three highest quality Indonesian plantations in the East of Java. The local productions are checked all year round by subsidiary Tribù Asia, based in Semarang and led by a European management. Tribù designs its furniture in the way that the wood is used as efficiently as possible.

Teak is classed as the most premium wood on the planet and therefore the most suitable species for outdoor furniture. Beyond its beauty, teak possesses some natural properties that other woods don't have. It is extremely durable, stable, water and weather resistant. This is due to the high levels of natural oils which result in minimal moisture absorption, giving it great stability. Moreover, the wood is extremely resistant to fungi, as well as against parasite attacks and insects.

A tree is mature after 75 to 80 years. The trees are ringed, which means that the lower band of the bark is removed. The tree then loses most of its sap. About two years later it is felled and sawed up. Tribù selects each log based on its structure. Drying the wood is a very important phase and determines how it reacts later on. The time and speed of drying depends on the thickness of the material. Ideally the level of moisture lies between 8 and 12%.

### MAINTENANCE

Teak left in its natural state, is virtually maintenance-free. It can be left outside all year round, surviving even the most extreme weather conditions. New teak will experience natural oil surfacing that appears like a "watermark" or irregular pattern of discoloration. These areas are part of the natural maturing process and can be removed with gentle washing with Teak Super Cleaner (p. 204).

Over time, untreated teak furniture which is exposed to sun and rain will turn silver grey. This process is cosmetic and does not harm the strength or quality of the wood.

To avoid the annual cleaning of the wood, you can apply Teak Sealer (p. 204). Teak Sealer contains UV protection to slow down the graying from the sun as well as a fungicide to prevent the growth of mold and mildew. Teak Sealer can be applied to new teak or old teak furniture after it has been cleaned. We recommend using Teak Super Cleaner (p. 204) to clean soiled furniture. If Teak Sealer is applied every season, a simple cleaning with water and a pH neutral soap will do for years. Teak Sealer is a sealer and is not the same as varnish. It is breathable, letting the natural oils escape without bubbling or peeling like varnish.

Teak Protector (p. 205) protects the wood against stains and green deposit, without colouring the wood. We recommend to apply it after each cleaning.

### USE OF VARNISH AND OIL ON TEAK

Teak is protected by its own natural oils that migrate to the surface of the wood and make the wood virtually impervious to water. As such, the use of varnish and oil (especially linseed oil) on teak furniture is not recommended. Products such as varnish and polyurethane may peel and chip and require vigorous sanding to remove. Oiling teak does not prevent the wood from graying, and often results in mold and mildew growing on the furniture. Removing mold and mildew on the surface requires washing the furniture with bleach and soap followed by sanding. Tribù and authorities from the timber profession itself tend to advise against the use of teak oil.

### OIL STAINS ON CUSHIONS

Because teak does not absorb water and is rich in natural oils and silicates, the weathering process includes oil surfacing. This teak oil can cause stains on cushions. Fabric stained by natural teak oil can be cleaned with soap and water or a special eucalyptus-based cleaner. Please be aware oil surfacing is a naturally repeating process that cannot be prevented.



AMANU, DUNES, ELIO, HEXAGON, ILLUM, KOS, MOOD, NOMAD, PAVILION, PURE SOFA, ROOTS, SENJA, OTTO, TAIRU, T-TABLE, UKIYO & VIS À VIS



### INFORMATION

Comme Tribù ne fait aucune concession à la qualité, nous utilisons exclusivement des arbres adultes soigneusement sélectionnés, qui sont récoltés dans le respect des normes environnementales les plus strictes dans les trois plantations les plus qualitatives de l'est de Java. Les productions locales sont contrôlées pendant toute l'année par notre filiale Tribù Asia, établie à Semarang et dirigée par un management européen. Tribù conçoit ses meubles de façon à ce que le bois soit utilisé de la manière la plus efficace possible et qu'il y ait un minimum de déchets.

Le teck est considéré comme l'espèce de bois possédant la plus haute qualité au monde et constitue donc l'essence la plus appropriée pour le mobilier de jardin. Outre sa beauté, le teck possède une série de propriétés naturelles que ne possèdent pas les autres essences. Il est extrêmement durable, stable, et résiste à l'eau et aux intempéries. Cela s'explique par sa concentration élevée en huiles naturelles, qui résulte en une absorption minimale d'humidité et qui confère au bois une stabilité importante. En outre, le teck est extrêmement résistant aux champignons et insensible aux parasites et insectes.

Un arbre est adulte après 75 à 80 ans. Les arbres sont annelés, c.-à-d. que la partie inférieure de l'écorce est enlevée. L'arbre perd alors la plus grande partie de sa sève. Environ deux ans plus tard, l'arbre est abattu et débité. Tribù sélectionne chaque lot selon la structure de chaque dosse. Le séchage du bois constitue une phase très importante et détermine le comportement ultérieur du bois. La vitesse de séchage dépend de l'épaisseur du matériau. Le niveau idéal de l'hygrométrie se situe entre 8 et 12 %.

### ENTRETIEN

Le teck est une essence unique qui n'exige pratiquement pas d'entretien dans son état naturel. Les meubles en teck peuvent rester au grand air pendant toute l'année, même dans les intempéries les plus extrêmes. Chez le teck neuf, un « filigrane » ou motif de décoloration irrégulière peut apparaître en raison de la migration de l'huile naturelle vers la surface. Cela fait partie du processus de vieillissement naturel, et peut être éliminé par un nettoyage doux au Teak Super Cleaner (p. 204).

Après un certain temps, le teck non traité prendra une teinte gris argent en raison de son exposition au soleil et à la pluie. Il s'agit d'un processus esthétique qui n'a aucune influence sur la résistance ou la qualité du bois. Afin d'éviter le nettoyage annuel du teck, vous pouvez appliquer du Teak Sealer (p. 204). Ce produit contient une protection UV pour ralentir le grisonnement par le soleil, ainsi qu'un fongicide pour empêcher la prolifération de moisissures et de mildiou. Teak Sealer peut être utilisé pour un mobilier en teck neuf ou ancien après que celui-ci ait été nettoyé. Nous recommandons d'utiliser Teak Super Cleaner (p. 204) en cas de mobilier encrassé. Si vous appliquez le Teak Sealer chaque saison, un simple nettoyage avec de l'eau et un savon au pH neutre suffira pendant des années. Le Teak Sealer est un scellant, ce qui n'est pas la même chose qu'un vernis. Il est respirant, ce qui permet aux huiles naturelles de s'évaporer sans formation de cloques ou d'écaillage.

Le Teak Protector (p. 205) protège le bois contre les taches et les dépôts verts, sans teindre le bois; il est conseillé de l'appliquer après chaque nettoyage.

### UTILISATION DE VERNIS ET D'HUILE SUR LE TECK

Le teck est protégé par ses propres huiles naturelles qui migrent vers la surface du bois et qui le rendent étanche. L'utilisation de vernis et d'huile (surtout l'huile de lin) sur le teck est déconseillée. Les produits comme le vernis ou le polyuréthane peuvent s'écailler et peuvent être éliminés uniquement par un ponçage énergique. Huiler le teck n'empêche pas le bois de griser et provoque souvent des moisissures et l'apparition de mildiou. Ils peuvent être éliminés avec un blanchiment et du savon, suivis par un ponçage. Tribù et l'industrie du bois conseillent de ne pas utiliser d'huile sur le teck.

### TACHES DE TECK SUR LES COUSSINS

Comme le teck n'absorbe pas d'eau et est riche en huiles naturelles et en silicates, l'huile finit toujours par remonter spontanément. Cette huile peut provoquer des taches sur les coussins, qui peuvent être éliminées avec de l'eau et du savon ou un nettoyant spécial à base d'eucalyptus. Il faut tenir compte du fait que la remontée d'huile est un phénomène naturel et répétitif qu'il n'est pas possible de prévenir.

AMANU, DUNES, ELIO, HEXAGON, ILLUM, KOS, MOOD, NOMAD, PAVILION, PURE SOFA, ROOTS, SENJA, OTTO, TAIRU, T-TABLE, UKIYO & VIS À VIS



### INFORMATIE

Omdat Tribù geen toegevingen doet als het gaat over kwaliteit, worden enkel zorgvuldig geselecteerde, volgroeide teakbomen gebruikt, die met respect voor de strengste milieunormen geoogst worden uit de drie meest kwalitatieve plantages uit Oost-Java. De plaatselijke producties worden het hele jaar door gecontroleerd door dochterfirma Tribù Asia, gevestigd in Semarang en geleid door een Europees management. Tribù ontwerpt zijn meubels op die manier dat het hout zo efficiënt mogelijk gebruikt wordt en er zo weinig mogelijk afval is.

Teak wordt geclassificeerd als de meest superieure houtsoort ter wereld en is daarom de meest geschikte soort voor buitenmeubilair. Naast zijn schoonheid, beschikt teak over een aantal natuurlijke eigenschappen die andere houtsoorten niet hebben. Het is uiterst duurzaam, stabiel en water- en weerbestendig. Dit komt door het hoge niveau van natuurlijke oliën wat resulteert in een minimale vochtabsorptie, waardoor het hout een grote stabiliteit krijgt. Bovendien is teakhout extreem schimmelbestendig, alsook bestand tegen parasieten en insecten.

Een boom is volgroeid na 75 tot 80 jaar. De bomen worden geringd, dit wil zeggen dat de onderste laag van de bast verwijderd wordt. De boom verliest dan het meeste van zijn sap. Ongeveer twee jaar later wordt de boom gekapt en verzaagd. Tribù selecteert elk lot stuk per stuk op zijn structuur. Het drogen van het hout is een zeer belangrijke fase en bepaalt hoe het later zal reageren. De snelheid van het drogen hangt af van de dikte van het materiaal. Het ideale niveau van het vochtgehalte ligt tussen 8 en 12%.

### ONDERHOUD

Teak is een unieke houtsoort die in zijn natuurlijke toestand vrijwel geen onderhoud vraagt. Teakmeubelen kunnen heel het jaar door buiten blijven, zelfs in de meest extreme weeromstandigheden. Bij nieuwe teak kan een 'watermerk' of een onregelmatig patroon van verkleuring verschijnen door de natuurlijke olie die naar boven komt. Dit maakt deel uit van het natuurlijke rijpingsproces en kan verwijderd worden met een zachte reiniging met Teak Super Cleaner (p. 204).

Na verloop van tijd zal onbehandeld teak door blootstelling aan zon en regen zilvergrijs kleuren. Dit is een esthetisch proces en heeft geen invloed op de sterkte of kwaliteit van het hout. Om de jaarlijkse reiniging met Teak Cleaner te vermijden, kan u het teak met Teak Sealer (p. 204) behandelen. Teak Sealer bevat UV bescherming om vergrijzing door de zon te vertragen, alsook een fungicide om de groei van schimmel en meeldauw te voorkomen. Teak Sealer kan gebruikt worden voor nieuw of oud teak meubilair nadat het gereinigd is. Wij raden aan om Teak Super Cleaner (p. 204) te gebruiken bij vervuild meubilair. Als u Teak Sealer 1x per seizoen aanbrengt, volstaat gedurende jaren een eenvoudige reiniging met water en een neutrale zeep. Teak Sealer is een sealer en is niet hetzelfde als vernis. Het is ademend, waardoor de natuurlijke oliën kunnen ontsnappen zonder bubbelvorming of afbladderend.

Teak Protector (p. 205) beschermt het hout tegen vlekken en groenaanslag, zonder het hout te kleuren en brengt u best na elke reiniging aan.

### GEBRUIK VAN VERNIS EN OLIE OP TEAK

Teak wordt beschermd door zijn eigen natuurlijke oliën die migreren naar het oppervlak van het hout en die het hout waterdicht maken. Het gebruik van vernis en olie (vooral lijnzaadolie) op teak worden afgeraden. Producten zoals vernis en polyurethaan kunnen afbladderen en kunnen enkel verwijderd worden door krachtig schuren. Teak oliën voorkomen niet dat het hout gaat vergrijzen en veroorzaakt vaak schimmel en groei van meeldauw. Deze kunnen verwijderd worden met bleekmiddel en zeep, gevolgd door schuren. Tribù en de houtindustrie adviseren om geen olie te gebruiken op teak.

### TEAKVLEKKEN OP KUSSENS

Omdat teak geen water absorbeert en rijk is aan natuurlijke oliën en silicaten, komt die natuurlijke olie met de tijd spontaan naar boven. Deze olie kan vlekken op kussens veroorzaken die verwijderd kunnen worden met zeep en water of een speciaal reinigingsmiddel op basis van eucalyptus. Gelieve in acht te nemen dat het aan de oppervlakte komen van olie een natuurlijk, herhalend proces is, dat niet kan voorkomen worden.



# TEXTILENE STRAPS

BANDES TEXTILENE - TEXTILEEN BANDEN

---

NATAL ALU SOFA

---



## INFORMATION

The textilene straps of the Natal Alu Sofa consist of a coated polyester weave. The combination of PVC and polyester guarantees a lasting high tension and provides an excellent resistance to all weather conditions. The straps dry quickly and are stain repellent. A fungi-repellent treatment prevents the formation of mold.

## MAINTENANCE

The textilene straps are easy to clean with clear water and a pH-neutral soap. Stubborn stains can be removed with Synthetics Super Cleaner (p. 208). If necessary, use a soft brush to remove dirt between the straps. Do not use acid, alkaline or chlorinated products that can harm the hardware of your furniture.

For extra protection we recommend Synthetics Protector (p. 208) which applies an invisible film and reduces the adhesion of dirt.

---

## INFORMATION

Les bandes en textilène du Natal Alu Sofa sont constituées d'un tissage en polyester couché, tout comme les Batyline. La composition du matériau garantit une tension prolongée et élevée de l'assise, ainsi qu'une excellente résistance aux intempéries. Les bandes ne se décolorent pas, sont insensibles aux taches et sèchent rapidement. Un traitement antimoisissures prévient la prolifération de moisissures par l'humidité.

## ENTRETIEN

Les bandes textilène peuvent être nettoyées simplement avec de l'eau pure et un détergent liquide à pH neutre. Pour les taches récalcitrantes, vous pouvez utiliser Synthetics Super Cleaner (p. 208). Utilisez une brosse douce pour éliminer les saletés entre le tissage. N'employez pas de sel ou de produits contenant du chlore, car ceux-ci pourraient attaquer la carcasse du meuble.

Pour une protection supplémentaire, nous recommandons du Synthetics Protector (p. 208) qui applique un film invisible réduisant l'incrustation de saletés.

---

## INFORMATIE

De textieleen banden van de Natal Alu Sofa bestaan uit een weving van gecoat polyester, net als de Batylines. De samenstelling van het materiaal garandeert een langdurige en hoge spanning van de zitting en een uitstekende weerbestendigheid. De banden verkleuren niet, zijn vlekwerend en drogen snel. Een schimmelwerende behandeling voorkomt het ontstaan van schimmel door vocht.

## ONDERHOUD

De textieleen banden zijn eenvoudig te reinigen met zuiver water en een pH-neutraal, vloeibaar detergent. Voor hardnekkige vlekken kan u Synthetics Super Cleaner (p. 208) gebruiken. Met een zachte borstel kan u vuil tussen de banden verwijderen. Gebruik geen zout of chloorhoudende producten omdat die de hardware van het meubel zou kunnen aantasten.

Voor extra bescherming raden we Synthetics Protector (p. 208) aan die een onzichtbare film aanbrengt die de aanhechting van vuil vermindert.



### INFORMATION

The extra-large weave that is used for the Tosca collection is made with a material that was developed exclusively by Tribù. A great deal of research went into the material, resulting in a unique product with a natural and soft appearance, that is nevertheless 100% weatherproof. An EPDM foam filling is over braided with a tubular, seamless cover of knitted textile and Tricord (polyolefin). The material is fungi-resistant, stain-repellent, does not fade and dries relatively quickly. It is 100% suitable for outdoor use in any environment. However, to minimize cleaning, we advise to use our covers when not using the furniture.

### MAINTENANCE

Rinse the braiding regularly with clean water. For intensive cleaning, use Synthetics Super Cleaner (p. 208). This cleaner also works perfectly for the powdercoated stainless steel frame. Always rinse the furniture with clean water after treatment with cleaning agents. Allow the braid to dry and treat with Textile Protector (p. 209). This will apply an invisible stain repellent film which enables the furniture to dry quicker. The cleaning will also become easier, less frequent and requires mainly rinsing with clean water.

---

### INFORMATION

Le tissage extralarge employé pour la collection Tosca est une exclusivité mise au point par Tribù. Il a fallu de longues recherches pour trouver un matériau à l'aspect doux et naturel, mais cependant 100 % résistant aux intempéries. Une housse sans coutures en textile et Tricord (polyoléfine) est tricotée autour d'un garnissage en mousse EPDM. Le matériau résiste aux moisissures, aux taches et aux UV, et sèche relativement vite. Il convient pour être utilisé au grand air dans n'importe quel environnement. Pour limiter au maximum le nettoyage, nous conseillons de protéger les meubles avec des housses lorsque vous ne les utilisez pas.

### ENTRETIEN

Nettoyez régulièrement le tissage avec de l'eau pure. Les taches récalcitrantes peuvent être éliminées avec le Synthetics Super Cleaner (p. 208). Ce produit peut être utilisé également pour nettoyer le cadre en inox revêtu de laque en poudre. Rincez toujours bien les meubles à l'eau pure. Après nettoyage avec des produits de nettoyage laissez bien sécher le tissage et traitez-le ensuite avec Textile Protector (p. 209), qui le rend résistant aux taches et lui permet de sécher plus rapidement. Le nettoyage deviendra ainsi plus facile et pourra être effectué moins fréquemment.

---

### INFORMATIE

De extra brede weving die gebruikt wordt voor de Tosca collectie werd exclusief door Tribù ontwikkeld. Er ging veel research aan vooraf om te komen tot een materiaal dat er zacht en natuurlijk uitziet, maar toch 100% weerbestendig is. Rond een EPDM schuimvulling wordt een naadloze hoos van textieleen en Tricord (polyolefine) gebreid. Het materiaal is schimmel-, vlek- en UV bestendig en droogt relatief snel. Het is geschikt voor buitengebruik in elke omgeving. Om reinigen tot een minimum te beperken, raden we wel aan de meubelen te bedekken met beschermhoezen als u ze niet gebruikt.

### ONDERHOUD

Reinig de weving regelmatig met zuiver water. Hardnekkige vlekken kunnen verwijderd worden met Synthetics Super Cleaner (p. 208). Dit product kan ook gebruikt worden om het gepoederlakte rvs frame te reinigen. Spoel de meubelen altijd goed na met zuiver water. Laat de weving goed drogen en behandel daarna met Textile Protector (p. 209) die vlekwerend werkt en ervoor zorgt dat de weving sneller droogt. Het reinigen zal hierdoor makkelijker worden en minder frequent nodig zijn.





#### INFORMATION

Travertine, a captivating natural stone, boasts unique characteristics and extensive applications. Formed by mineral deposits in natural springs, it features a distinctive porous texture that lends an elegant and rustic charm to both indoor and outdoor spaces. Its soft, neutral tones range from warm beige to cool gray, ensuring that every top is unique.

This originality is intensified by the stain-sensitive nature of the material. Oil, red wine, as well as other liquids and acids are absorbed, resulting in a permanent stain. This makes it a 'living thing' that, in time, displays subtle changes in colour and even surface structure. A product that becomes more and more unique with use, perfect for people who appreciate a table with personality.

#### MAINTENANCE

For daily cleaning, rub with a soft clean cloth immersed in a solution of hot, pure water and a pH-neutral detergent. Rinse thoroughly and leave to dry. Spills should be wiped up immediately, particularly acids, which can stain. Bird droppings and leaves can also stain if not removed immediately. We advise you to cover your table with a protective cover when not in use.

#### INFORMATION

Le travertin, une pierre naturelle captivante, possède des caractéristiques uniques et de nombreuses applications. Formé par les dépôts minéraux des sources naturelles, il présente une texture poreuse distincte qui confère un charme élégant et rustique aux espaces intérieurs et extérieurs. Ses tons doux et neutres se déclinent du beige chaud au gris froid, ce qui fait de chaque surface un objet unique.

Cette originalité est renforcée par la sensibilité du matériau aux taches. Il absorbe l'huile, le vin rouge, ainsi que d'autres liquides et acides pour créer une tache indélébile. Il est donc « vivant » et sa surface présente, avec le temps, de subtils changements de couleur et même de structure pour former un produit dont le caractère unique s'affirme au fil des utilisations. Il est donc parfait pour les personnes qui aiment une table avec de la personnalité.

#### ENTRETIEN

Pour le nettoyage quotidien, frottez le produit avec un chiffon doux et propre plongé au préalable dans une solution d'eau chaude et d'un détergent au pH neutre. Rincez abondamment et laissez sécher. Les liquides renversés doivent être essuyés immédiatement, en particulier les acides, qui peuvent laisser des taches. Les fientes d'oiseaux et les feuilles peuvent également provoquer des taches si elles ne sont pas essuyées immédiatement. Nous vous recommandons d'utiliser une housse de protection lorsque vous n'utilisez pas votre table.

#### INFORMATIE

Travertine ziet er uniek uit en kan voor talrijke zaken worden aangewend. Deze steensoort wordt gevormd door natuurlijke minerale afzettingen en heeft een kenmerkende poreuze textuur die zowel binnen als buiten een elegante en rustieke charme uitstraalt. De zachte, neutrale tinten van warmbeige tot koel grijs garanderen een uniek tafelblad.

Het bijzondere karakter wordt versterkt door de vlekgevoeligheid van het materiaal. Olie, rode wijn, maar ook andere vloeistoffen en zuren worden geabsorbeerd, waardoor een permanente vlek ontstaat. Het product is gemaakt van een 'levend materiaal' dat na verloop van tijd subtiele veranderingen in kleur en zelfs oppervlaktestructuur vertoont. Een product dat met gebruik zijn eigen karakter verder ontwikkelt, speciaal voor mensen die een tafel met persoonlijkheid waarderen.

#### ONDERHOUD

Dompel voor dagelijkse reiniging een zachte, propere doek onder in een oplossing van warm, zuiver water en een pH-neutraal vloeibaar reinigingsmiddel. Spoel grondig af en laat drogen. Vlekken dienen onmiddellijk te worden afgeveegd, vooral zure stoffen daar ze permanente vlekken kunnen veroorzaken. Ook vogeluitwerpselen en bladeren kunnen permanente vlekken veroorzaken als ze niet onmiddellijk worden verwijderd. We raden u aan een beschermhoes te gebruiken als u uw tafel niet gebruikt.



#### INFORMATION

Tricord® is a brand new composite material for which Tribù has exclusivity. It is a unique combination of nautical and synthetic fibres. The inside consists of unbreakable polyester that gives it strength and stability. The outside is a combination of nautical fibres that create a surprisingly soft touch and natural appearance. The composition of these nautical fibres (polyofin) makes Tricord® completely resistant to outside influences: frost, water, fungi and UV-rays.

The furniture is hand woven - no two pieces are ever alike. The unique craft appearance is part and parcel of the charm of the product and cannot be regarded as a fault. The backs of the Mood and CTR collection can be purchased individually and easily replaced if necessary.

#### MAINTENANCE

Before use, we recommend to treat the Tricord® weave with Textile Protector (p. 209) which applies an invisible, dirt and water repellent film. The straps can be cleaned with clear water and a ph-neutral detergent or Synthetics Super Cleaner (p. 208). Allow the detergent to act for a while, then rinse abundantly with clean water. Drying may take a while on cloudy days.

After cleaning, treat with Textile Protector (p. 209). The cleaning will become easier and will require mainly rinsing with clean water.

#### INFORMATION

Tricord® est un matériau composite tout à fait nouveau, spécialement mis au point pour Tribù. Il s'agit d'une combinaison unique de fibres nautiques et de synthétique. L'intérieur est constitué de fibres polyester incassables qui assurent résistance et stabilité. L'extérieur est une combinaison de fibres nautiques qui confèrent au matériau un toucher et une apparence naturels. La composition de ces fibres nautiques (polyoléfine) fait que Tricord® est totalement résistant au grand air: résistant au gel, à l'eau, aux moisissures et aux UV. Les meubles sont tissés à la main, il n'y a pas deux pièces identiques. L'aspect artisanal unique ainsi conféré au produit, fait partie de son charme et ne peut être considéré comme un défaut. Les dossiers des collections Mood et CTR peuvent être obtenus séparément et peuvent être remplacés facilement en cas de besoin.

#### ENTRETIEN

Avant l'emploi, nous recommandons de vaporiser les bandes Tricord® avec Textile Protector (p. 209), qui crée un film invisible résistant aux taches et hydrofuge. Les bandes peuvent être nettoyées avec de l'eau pure et un détergent liquide à pH neutre ou Synthetics Super Cleaner (p. 208). Il est recommandé de laisser agir un peu le détergent. Rincez abondamment avec de l'eau. Le séchage peut prendre un certain temps pendant les journées sans soleil.

Après nettoyage traitez les bandes avec Textile Protector (p. 209), le nettoyage deviendra ainsi plus facile et devra être effectué moins fréquemment.

#### INFORMATIE

Tricord® is een gloednieuw composietmateriaal speciaal ontwikkeld voor Tribù. Het is een unieke combinatie van nautische vezels en kunststof. De binnenzijde bestaat uit onbreekbare polyestervezels die voor sterkte en stabiliteit zorgen. De buitenzijde is een combinatie van nautische vezels die het materiaal een natuurlijk gevoel en uitstraling geven. De samenstelling van deze nautische vezels (polyofine) zorgt ervoor dat Tricord® volledig buitenbestendig is: vorst-, water-, schimmel- en UV-bestendig. De meubels worden met de hand geweven, geen enkel stuk is hetzelfde. Het unieke, artisanale uitzicht dat hieruit ontstaat, maakt deel uit van de charme van het product en kan niet gezien worden als een fout. De ruggen van de Mood en CTR collectie kunnen apart verkregen worden en zijn makkelijk te vervangen indien nodig.

#### ONDERHOUD

Vóór gebruik raden we aan de Tricord® weving in te spuiten met Textile Protector (p. 209) dat een zichtbare film legt die vlekbestendig en waterafstotend werkt. Reinigen kan met zuiver water en een pH-neutraal, vloeibaar detergent of Synthetics Super Cleaner (p. 208). Het detergent best even laten inwerken. Overvloedig spoelen met water. Het drogen kan een tijdje duren op niet-zonnige dagen.

Behandel daarna met Textile Protector (p. 209) dat vlekwerend werkt en ervoor zorgt dat de weving sneller droogt. Het reinigen zal hierdoor makkelijker worden en minder frequent nodig zijn.







## INFORMATION

Vilex material is composed of solution-dyed PVC-coated polyester. This characteristic not only grants Vilex products outstanding UV resistance but also imparts effortless cleanability due to the non-absorbent nature of the yarns. These yarns facilitate rapid drying and exhibit stain-repelling qualities. Every item crafted from Vilex undergoes a manual weaving process, contributing to an artisanal aesthetic and ensuring the distinctiveness of each product.

## MAINTENANCE

Vacuum the material regularly to remove loose dirt. Clean with a garden hose and remove stubborn stains with Synthetics Super Cleaner (p. 208). To protect against stains, Synthetics Protector (p. 208) can be used which applies an invisible film.

## INFORMATION

Le matériau Vilex est composé de polyester enduit de PVC teinté dans la masse. Cette caractéristique confère aux produits Vilex une résistance exceptionnelle aux UV, ainsi qu'une facilité de nettoyage grâce à la nature non absorbante des fils. Ces fils permettent un séchage rapide et présentent des qualités anti-taches. Chaque article confectionné en Vilex est soumis à un processus de tissage manuel, ce qui lui confère une esthétique artisanale et garantit le caractère distinctif de chacun des produits.

## ENTRETIEN

Passez régulièrement l'aspirateur sur le matériau pour enlever les saletés qui s'y sont déposées. Pour le nettoyage, utilisez un tuyau d'arrosage et éliminez les taches tenaces avec Synthetics Super Cleaner (p. 208). Pour protéger le produit contre les taches, utilisez le Synthetics Protector (p.208) qui laisse un film invisible

## INFORMATIE

Vilex is gemaakt van in de massa geverfd pvc-gecoat polyester. Hierdoor hebben ze een uitstekende uv-bestendigheid en zijn ze niet-absorberend waardoor ze gemakkelijk schoon te maken zijn. Vilex droogt snel en is vlekafstotend. Elk Vilex-product wordt met de hand geweven, wat bijdraagt tot de ambachtelijke uitstraling die uniek is voor elk product.

## ONDERHOUD

Stofzuig het product regelmatig om los vuil te verwijderen. Reinig met een tuinslang of zelfs een hogedrukreiniger. Hardnekkige vlekken kunnen verwijderd worden met Synthetics Super Cleaner (p. 208). Om het tapijt te beschermen tegen vlekken, kan Synthetics Protector (p. 208) gebruikt worden dat een onzichtbare, vuilafstotende film aanbrengt.





#### INFORMATION

Trizo, made from HDPE material, is a sturdy water- and mold-resistant material suitable for various environments. This material is colorfast and mass-colored, making it perfect for outdoor use.



#### MAINTENANCE

Trizo is easy to maintain. To remove stains, use warm, clean water and a pH neutral liquid cleaner or Synthetics Super Cleaner (p. 208). Gently buffing can help with minor scratches, so be sure not to use harsh abrasives. Using a cover can provide extra protection for the material and reduce the number of necessary maintenance sessions. For additional protection, we recommend the Synthetic Protector (p. 208), which forms an invisible layer that repels dirt.

#### INFORMATION

Fabriqué à partir de PEHD, Trizo est un matériau robuste, résistant à l'eau et à la moisissure, qui convient à divers environnements. Ce matériau est inaltérable et coloré dans la masse, idéal pour une utilisation en extérieur.

#### ENTRETIEN

Trizo est facile à entretenir. Pour enlever les taches, utilisez de l'eau chaude et propre et un détergent liquide au pH neutre ou notre Synthetics Super Cleaner (p. 208). Un léger lustrage peut aider à gommer les petites rayures, mais veillez à ne pas utiliser d'abrasifs trop agressifs. L'utilisation d'une housse offre une protection supplémentaire au matériau et permet de réduire le besoin d'entretien. Pour une protection supplémentaire, nous recommandons le Synthetic Protector (p. 208), qui laisse un film protecteur pour repousser la saleté.

#### INFORMATIE

Trizo, gemaakt van HDPE-materiaal, is een stevig water- en schimmelbestendig materiaal dat geschikt is voor diverse omgevingen. Dit materiaal is in de massa gekleurd voor levendige, kleurvaste kleuren, perfect om buiten te gebruiken.

#### ONDERHOUD

Trizo is gemakkelijk te onderhouden. Gebruik een oplossing van warm, zuiver water en een pH-neutraal vloeibaar reinigingsmiddel of de Synthetics Super Cleaner (p. 208) om vlekken te verwijderen. Zacht schuren verhelpt kleine krassen zodat Trizo zijn charme behoudt, gebruik hier zeker geen harde schuurmiddelen voor. Het gebruik van een cover kan het materiaal extra bescherming bieden en het aantal benodigde onderhoudsbeurten verminderen. We raden de Synthetics Protector (p. 208) aan voor extra bescherming, dit product vormt een onzichtbaar laagje dat vuil afstoot.



















#### TEAK SUPER CLEANER - D9914 - 500 ml

Cleaner for regular or intensive cleaning.

1. First moisten the furniture with clear water.
2. Shake the Teak Cleaner well before use.
3. Apply Teak Cleaner with a soft cloth and allow to soak for 3 minutes.
4. Brush the furniture clean with the soft scrubbing pad in the direction of the grain.
5. Rinse well with clear water.

Produit pour un nettoyage normal ou intensif.

1. Mouillez d'abord le meuble avec de l'eau.
2. Agitez Teak Cleaner avant l'emploi.
3. Appliquez Teak Cleaner avec un chiffon sur le meuble et laissez agir 3 minutes.
4. Brossez le meuble avec le patin de ponçage doux en suivant le fil du bois.
5. Rincez bien le meuble à l'eau.

Reiniger voor normale of intensieve reiniging.

1. Het meubel eerst vochtig maken met water.
2. Teak Cleaner schudden voor gebruik.
3. Breng de Teak cleaner met een doek op het meubel aan en laat dit 3 minuten intrekken.
4. Borstel het meubel met het zachte schuurpad richting houtnerf schoon.
5. Het meubel goed afspoelen met water.



#### TEAK SEALER NATURAL - D9959 - 1000 ml

When Teak Sealer is applied every season, a labour-intensive cleaning with Teak Cleaner will not be necessary for many years. A simple cleaning with water and ph-neutral soap will do.

1. Allow new teak to weather for 1 to 2 weeks before applying Teak Sealer.
2. Clean soiled teak with Teak Cleaner or Teak Super Cleaner and leave to dry until the wood is completely dry.
3. Stir the Teak Sealer well and keep mixing throughout the application process.
4. Apply to the teak using a microfiber cloth, synthetic sponge or plants spray in the direction of the grain. Wipe any excess off with a microfiber cloth.
5. Leave to dry for 1 hour and apply a second coat.
6. Wipe over the second coat with a clean cloth.
7. The teak should be dry to the touch in 1 hour and ready for use the next day.

Appliquer Teak Sealer une fois par saison permet de se passer d'un nettoyage intensif avec Teak Cleaner pendant plusieurs années. Nettoyer de temps en temps à l'eau avec un savon au pH neutre entre les traitements suffira.

1. Laissez le teck neuf se patiner une ou deux semaines avant le traitement.
2. Nettoyez soigneusement le teck souillé avec Teak Cleaner ou Teak Super Cleaner et laissez bien sécher.
3. Remuez bien le Teak Sealer et continuez à remuer souvent pendant l'application.
4. Appliquez avec un chiffon en microfibre, une éponge synthétique ou un pulvérisateur plante dans le sens du bois. Essuyez le produit excédentaire avec un chiffon en microfibre.
5. La 1re couche est sèche au bout d'une heure. Appliquez immédiatement une 2e couche.
6. Frottez avec un chiffon propre ne peluchant pas.
7. Le bois est sec hors poussière au bout d'une heure et prêt à l'emploi le lendemain.

Als u elk seizoen Teak Sealer aanbrengt, is een arbeidsintensieve reiniging met Teak Cleaner jarenlang niet meer nodig. Een eenvoudige reiniging met water en een neutrale zeep volstaat.

1. Nieuwe teak eerst 1 tot 2 weken laten verweren vóór behandeling met Teak Sealer.
2. Vervuilde teak grondig reinigen met Teak Cleaner of Teak Super Cleaner en goed laten drogen.
3. Teak Sealer goed roeren, ook tijdens de verwerking.
4. Aanbrengen met een microvezeldoek, een kunstspoon of een plantensproeier in de richting van de nerven, overtollig product met een microvezeldoek wegvegen.
5. 1 uur laten drogen en 2de laag aanbrengen.
6. Opwrijven met schone pluisvrije doek.
7. Na 1 uur stofdroog, volgende dag gebruiksklaar



### TEAK PROTECTOR GREY COLOUR - D9912 - 500 ml

Protects the teak against stains and green deposit. Doesn't colour the grey patina

1. New teak: leave your new furniture outside during a few weeks until they get a pale colour.
2. Old, grey teak: clean the teak first with Teak Cleaner. If the cleaned wood feels rough, sand slightly before using the Teak Protector.
3. Make sure that the teak is 100% dry and free of dust.
4. Shake the bottle for at least one minute. Apply with the soft and lint-free cloth and allow to soak in the teak.
5. Allow to dry for 4 hours, then apply a second layer.
6. Let the teak dry for 24 hours before exposing it to moisture.

Protège le teck des taches et de la mousse. Ne colore pas la patine grise.

1. Teck neuf: placez d'abord les meubles quelques semaines dehors afin qu'ils prennent une couleur jaune pâle.
2. Teck vieux et grisé: nettoyez d'abord le bois avec Teak Cleaner. Si la surface du teck est rugueuse, poncez-la légèrement.
3. Assurez-vous que le teck soit 100 % sec et dépoussiéré.
4. Agitez Teak Protector au moins une minute avant d'appliquer. Appliquez une couche avec un chiffon doux ne peluchant pas. Laissez agir.
5. Appliquez une seconde couche au bout de 4 heures.
6. Laissez le teck sécher pendant 24 heures avant de l'exposer aux intempéries.

Beschermt de teak tegen vlekken en mos. Kleurt de grijze patina niet.

1. Nieuw teak: zet de teak meubels eerst enkele weken buiten zodat ze een wat bleekgele kleur krijgen.
2. Oud, donkergrijs teak: maak het teak eerst schoon met Teak Cleaner. Als het teak ruw aanvoelt, schuur het lichtjes op.
3. Zorg dat het teak 100% droog is en stofvrij.
4. Teak Protector voor gebruik minstens één minuut goed schudden. Breng één laag aan met een zachte, pluïsvrije doek. Laat goed intrekken.
5. Breng na 4 uur droogtijd een tweede laag aan.
6. Laat het teak nu 24 uur drogen alvorens het aan de weersomstandigheden bloot te stellen.





#### POWDERCOATED ALUMINIUM & STAINLESS STEEL CLEANER - D9952 - 500 ml

Cleans powdercoated aluminium and powdercoated stainless steel.

1. Rinse the furniture with clear water to eliminate loose dirt.
2. Spray the Coated aluminium & stainless steel Cleaner on the surface and let it rest.
3. In case of stubborn stains use a brush to remove the dirt from the pores.
4. Rinse with clear water and remove the dirt with a clean, moist cloth.
5. Dry with a microfiber cloth. Don't leave the surface to dry in full sun, this can leave white traces behind.

Nettoie l'aluminium et l'innox laqué par poudrage.

1. Rincez le meuble d'abord afin d'éliminer des saletés.
2. Pulvérissez Coated aluminium & stainless steel Cleaner de bas en haut sur la surface et laissez agir.
3. Si la saleté est incrustée, utilisez une brosse pour éliminer la saleté des pores.
4. Rincez avec de l'eau claire et éliminez la saleté avec un chiffon propre et humide.
5. Séchez avec un chiffon microfibre. Ne laissez pas sécher en plein soleil (peut laisser des traînées blanches).

Reinigt gepoederlakt aluminium en gepoederlakt roestvast staal.

1. Spoel het meubel eerst om los vuil te verwijderen.
2. Vernevel de Coated aluminium & stainless steel Cleaner over het oppervlak en laat inwerken.
3. Gebruik bij hardnekkig vuil een borstel om het vuil uit de poriën te verwijderen.
4. Spoel af met zuiver water en verwijder het vuil met een propere, vochtige doek.
5. Niet laten drogen in volle zon ( kan witte sporen achterlaten).

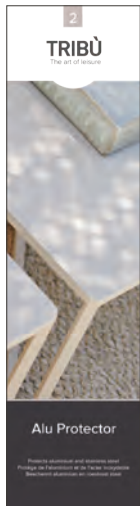

#### POWDERCOATED ALUMINIUM & STAINLESS STEEL PROTECTOR - D9931

Reduces the adhesion of dirt and fingerprints.

1. Shake well before use.
2. Spray onto a clean microfiber cloth and rub on the surface with circular movements.
3. Use a clean, dry microfiber cloth and spread well.

Réduit sensiblement l'adhérence de la saleté ou des empreintes.

1. Agitez bien avant l'emploi.
2. Pulvérissez sur un chiffon en microfibre et faites pénétrer en frottant légèrement avec des mouvements circulaires.
3. Utilisez un chiffon en microfibre propre et sec et frottez bien.

Vermindert gevoelig de aanhechting van vuil of vingerafdrukken.

1. Goed schudden voor gebruik.
2. Op een schone microvezeldoek spuiten en licht inwrijven met cirkelvormige bewegingen.
3. Gebruik een schone, droge microvezeldoek en wrijf goed uit.



### CERAMIC, LAVA STONE & GLASS CLEANER - D9938 - 500 ml

Removes local stains.

1. Shake well before use.
2. Spray the surface with the spray and leave for a while.
3. Rub to dry with a clean microfiber cloth and polish with a dry cloth.

Élimine les taches tenaces locales.

1. Agitez bien le flacon avec l'emploi.
2. Pulvérisez la mousse à la surface et laissez agir quelques instants.
3. Essuyez avec un chiffon propre au microfibre et séchez avec un chiffon sec.

Verwijdert plaatselijk hardnekkige vlekken.

1. Bus goed schudden voor gebruik.
2. Het oppervlak inspuiten met de schuimspray en even laten inwerken.
3. Droogwrijven met een propere, microvezel doek en nawrijven met een droge doek.



### CERAMIC, LAVA STONE & GLASS PROTECTOR - D9955 - 100 ml

Applies an invisible, dirt repellent coating.

1. Clean the surface with Ceramic, Lava Stone & Glass Cleaner.
2. It is essential that the surface is completely clean, dust free and dry before applying the Ceramic Protector.
3. Moisten a microfiber cloth with the Ceramic Protector and apply a layer to the surface, ensuring full and even coverage by fast circular movements.
4. Allow the newly coated surface to dry for a few minutes and then polish the surface with a clean microfiber cloth.

Offre une protection invisible contre les taches et la saleté.

1. Nettoyez parfaitement la surface avec Ceramic, Lava Stone & Glass Cleaner et rincez à l'eau claire. Il est important que la surface soit complètement propre, sèche et dépolvoiliée.
2. Imprégnez un chiffon en microfibre de Ceramic Protector et appliquez une couche uniforme en mouvements circulaires.
3. Continuez à frotter la surface jusqu'à ce que le chiffon soit presque sec.
4. Laissez sécher au minimum 1 minute (idéalement 5 minutes) et lustrez la surface avec un chiffon en microfibre propre.

Brengt een transparante, vuilwerende bescherming aan.

1. Maak het oppervlakte grondig schoon met Ceramic, Lava Stone & Glass Cleaner en spoel na met zuiver water. Het is belangrijk dat het oppervlak volledig schoon, droog en stofvrij is.
2. Doordreng een microvezel doek met Ceramic Protector en breng door middel van circulaire bewegingen een gelijkmatige coating aan.
3. Ga door met het oppervlak in te wrijven totdat de doek bijna droog is.
4. Laat minimum 1 minuut drogen (ideaal 5 minuten) en boen vervolgens het oppervlak met een schone microvezel doek.





#### SYNTHETICS SUPER CLEANER - D9922 - 500 ml

Cleans stubborn stains from synthetic materials, Canax®, CTR; Elio, Mood, Tosca weave and Batyline®.

1. Rinse the furniture with clear water to eliminate loose dirt.
2. Spray the Synthetics Super Cleaner on the surface and let it soak.
3. In case of stubborn stains use a brush to remove the dirt from the pores.
4. Rinse with clear water and remove the dirt with a clean, moist cloth.
5. Dry with a microfiber cloth. Don't leave the surface to dry in full sun, this can leave white traces behind.

Enlève des taches tenaces sur matériaux synthétiques, les tressages Canax®, CTR, Elio, Mood et Tosca et du Batyline®.

1. Rincez le meuble d'abord avec de l'eau claire afin d'enlever la saleté.
2. Pulvérisez Synthetics Super Cleaner sur la surface et laissez agir.
3. Si la saleté est incrustée, utilisez une brosse pour éliminer la saleté des pores.
4. Rincez et éliminez la saleté avec un chiffon propre, humide.
5. Séchez avec un chiffon en microfibre. Ne laissez pas sécher en plein soleil (peut causer des traînées blanches).

Verwijdert hardnekkige vlekken op kunststof, Canax®, CTR, Elio, Mood en Tosca weving en Batyline®.

1. Spoel het meubel eerst met zuiver water om loszittend vuil te verwijderen.
2. Vernevel de Synthetics Super Cleaner van onder naar boven over het oppervlak en laat inwerken.
3. Gebruik bij hardnekkig vuil een borstel om het vuil uit de poriën te verwijderen.
4. Spoel af en verwijder het vuil met een propere, vochtige doek.
5. Droogwrijven met een microvezeldoek. Niet laten drogen in volle zon ( kan witte sporen achterlaten).



#### SYNTHETICS PROTECTOR - D9921 - 500 ml

Applies an invisible film and protects against the adhesion of dirt. Suitable for synthetic materials, Canax® and Batyline®.

1. First clean your furniture with Synthetics Cleaner.
2. Shake the bottle well during at least one minute.
3. Apply a thin layer with a clean, dry and lint-free cloth.
4. Buff to shine with a soft, clean and dry cloth.

Offre une protection invisible contre les taches. A utiliser sur des matériaux synthétiques, Canax® et du Batyline®.

1. Nettoyez d'abord vos meubles avec Synthetics Cleaner.
2. Agitez Synthetics Protector au moins une minute avant d'appliquer.
3. Appliquez une couche mince avec un chiffon doux et sec.
4. Frottez ensuite avec un chiffon propre et sec jusqu'à ce que la surface devienne brillante.

Brengt een onzichtbare laag aan die beschermt tegen de aanhechting van vuil. Geschikt voor kunststof, Canax® en Tosca weving en Batyline®.

1. Reinig eerst uw meubels met Synthetics Cleaner.
2. Synthetics Protector vóór gebruik minstens één minuut goed schudden
3. Breng een dunne laag aan met een schone, droge doek.
4. Oppoetsen met een droge, schone doek tot er een glans ontstaat.



### TEXTILE PROTECTOR - D9924 - 400 ml

Makes fabric and weaves water and stain repellent.

1. Shake well before use.
2. Hold the spray can upright at a distance of approximately 30cm and vaporise in equal layers that slightly overlap each other.
3. Leave to dry.
4. For an optimal protection, after each cleaning, we recommend to use Textile Protector.

Rend des tissus et des tissages hydrofuges et résistants aux taches.

1. Agitez bien le flacon.
2. Pulvérisez en bandes se chevauchant légèrement. Maintenez le flacon droit et pulvérisez à +/- 30 cm de distance.
3. Laissez bien sécher.
4. Pour une protection parfaite, nous vous conseillons d'utiliser Textile Protector après chaque nettoyage.

Maak stoffen en wevingen waterafstotend en vlekwerend.

1. De bus goed schudden
2. De bus rechtop houden en spuiten op +/- 30cm afstand. Spuiten in banden die elkaar licht overlappen.
3. Goed laten drogen.
4. Voor een perfecte bescherming raden we aan na iedere reinigingsbeurt Textile Protector te gebruiken.



### GRANITE CLEANER/PROTECTOR - D9961 - 500 ml

Cleans, maintains and protects granite surfaces.

1. Shake before use, then open the spray valve.
2. Spray the surface in an evenly way.
3. Spread and polish with a microfiber cloth until no more streaks or veil is visible.

Nettoie, traite et protège des surfaces en granite.

1. Secouez avant utilisation, puis ouvrir la buse de pulvérisation
2. Pulvérisez bien régulièrement les surfaces.
3. Etalez et polissez avec un chiffon en microfibre, jusqu'à ce que plus aucune strie ou voile ne soit visible.

Reinigt, verzorgt en beschermt oppervlakken in graniet.

1. Schudden voor gebruik, daarna sproeiventiel openen.
2. Het oppervlak gelijkmatig besproeien.
3. Met een microvezeldoek verdelen en napolieren tot er geen strepen of sluier meer zichtbaar zijn.



**LIGHTENED CONCRETE CARE SET - D9964**

A complete set to take care of tables in lightened concrete.

- 1 Lightened Concrete Conditioner
- 1 Oil, wax & Grease Remover
- 1 sanding disc
- 1 brush
- 1 microfiber cloth

Un set complet pour l'entretien des tables en béton allégé.

- 1 Lightened Concrete Conditioner
- 1 Oil, wax & Grease Remover
- 1 disque de ponçage
- 1 brosse
- 1 chiffon en microfibre

Een complete set voor het onderhoud van tafels in verlicht beton.

- 1 Lightened Concrete Conditioner
- 1 Oil, Wax & Grease Remover
- 1 schuurschijfje
- 1 borstel
- 1 microvezeldoek

**LIGHTENED CONCRETE CONDITIONER – D9962 – 500ml**

Cleans surfaces in lightened concrete and protects against stains.

1. Wash the surface with clean water first and allow it to dry completely.
2. Shake before use, open the spray valve and spray lightly in an evenly way over the cooled surface.
3. Rub in with a clean, dry microfibre cloth with a circular motion or use a soft brush.
4. After approx. 10 minutes, remove the excess product with a clean, dry microfibre cloth until no more streaks or veil are visible.

Nettoie des surfaces en béton allégé et protège contre des taches.

1. Avant toute chose, nettoyez la surface à l'eau claire, puis laissez sécher complètement.
2. Secouez le flacon avant utilisation. Enclenchez le pulvérisateur et vaporisez uniformément une fine couche de produit.
3. Ensuite, frottez avec un chiffon microfibre sec et propre en effectuant des mouvements circulaires ou utilisez une brosse.
4. Après 10 minutes environ, retirez l'excédent de produit à l'aide d'un chiffon sec et propre jusqu'à ce que plus aucune strie ou voile ne soit visible.

Reinigt oppervlakken in verlicht beton en beschermt tegen vlekken.

1. Vooraf het oppervlak met zuiver water schoonmaken en volledig laten opdrogen.
2. De fles schudden voor gebruik, het sproeiventiel openen en het product lichtjes en gelijkmatig vernevelen over het afgekoelde oppervlak.
3. Vervolgens het product met een zuivere, droge microvezel doek met cirkelvormige bewegingen inwrijven of een borstel gebruiken.
4. Na ca 10min het overtollige product met een zuivere, droge microvezeldoek verwijderen tot er geen strepen of sluier meer zichtbaar zijn.

**OIL, WAX & GREASE REMOVER – D9963 – 250ml**

A creamy paste that removes stains on lightened concrete caused by oil, grease or candle wax.

1. Wash the surface with clean water first to remove any loose dirt and make sure it is completely dry before you apply the product.
2. Apply a layer of paste, approx. 1 mm thick, evenly over the stain using a spatula or brush and leave the paste to soak in. Apply in open air during daytime and dry weather only.
3. After drying for approx. 30-60 minutes, brush off the paste. Repeat this process for stubborn or old stains.
4. Rinse the furniture with clean water and let it dry.
5. For optimal protecting against stains, treat the surface with Tribù Lightened Concrete Conditioner.

Une pâte crémeuse qui enlève des taches causées par l'huile, la graisse ou la cire de bougie sur le béton allégé.

1. Avant toute chose, nettoyez le meuble à l'eau claire afin d'enlever toute trace de saleté. Assurez-vous qu'il est complètement sec avant d'appliquer le produit.
2. À l'aide d'une spatule ou d'une brosse, répartissez une couche uniforme d'environ 1 mm, et laissez agir. Appliquer en plein air pendant la journée et par temps sec uniquement.
3. Après 30-60 minutes environ, retirez la pâte avec une brosse. En cas de tache tenace ou ancienne, répétez l'opération.
4. Rincez à l'eau claire et laissez sécher.
5. Pour une protection optimale contre les taches, traitez le béton allégé avec du Tribù Lightened Concrete Conditioner.

Een smeijge pasta die vlekken op verlicht beton, veroorzaakt door olie, vet of kaarsvet verwijdt.

1. Spoel het meubel eerst met zuiver water om loszittend vuil te verwijderen en zorg dat het volledig droog is vooraleer je het product gebruikt.
2. Breng de pasta gelijkmatig met een spatel of borstel ca 1mm dik aan over de vlek en laat deze inwerken. Alleen overdag in open lucht en bij droog weer aanbrengen.
3. Na een droogtijd van ca 30-60min kan je de pasta afborstelen. Bij intense of oude vlekken moet dit proces eventueel meerdere keren herhaald worden.
4. Spoel het oppervlak met zuiver water en laat drogen.
5. Voor een optimale bescherming tegen vlekken, behandel het verlicht beton met Tribù Lightened Concrete Conditioner.



### INOX SUPER CLEANER (CB & EP) - D9918 - 250 ml

Intensive cleaner for in-depth cleaning.

1. Rinse the furniture with clear water and let it dry.
2. Shake the bottle well.
3. Apply the cleaner undiluted by dabbing by means of a damp sponge or pad. Apply in the rolling direction of the surface to be treated. Leave to act.
4. Remove the residue carefully with a damp cloth (be careful, loose dirt or oxide may cause minor scratches).
5. Rinse abundantly with clear water.

Nettoyant intensif pour des saletés tenaces.

1. Rincez le meuble et laissez sécher.
2. Agitez bien le flacon.
3. Appliquez le produit non dilué avec une éponge humide dans le sens du laminage du matériau ou dans le sens de la surface brossée ou meulée. Laissez agir.
4. Éliminer précautionneusement les résidus à l'eau ou avec un chiffon humide (attention : la saleté et/ou les oxydes détachés pourraient provoquer de légères rayures).
5. Rincez abondamment à l'eau claire.

Intensieve reiniger voor hardnekkige verontreiniging.

1. Spoel het meubel met zuiver water en laat drogen.
  2. De fles goed schudden.
  3. Breng de reiniger onverdund aan met een vochtige spons al deppend in de walsrichting van het materiaal. Even laten inweken.
  4. Verwijder residuen zorgvuldig met water of een vochtige doek (let op: het loskomend vuil en/of oxiden kunnen eventueel lichte krassen veroorzaken).
  5. Overvloedig spoelen met zuiver water.
-

# PRODUCTS

## PRODUITS - PRODUCTEN

---

### TRAVERTINE CONDITIONER - D9967

1. Cleaning: The surface must be clean, dry, and free of layers. For outdoor use, ensure that the stone does not contain harmful salts (nitrates, sulfates, chloride), as these can reduce the absorption capacity of the impregnation.
  2. Shake before use.
  3. To check the usage, color deepening, and effectiveness, it is recommended to test on a small surface.
  4. Processing temperature: 10°C to 25°C; avoid direct sun exposure and moisture until the product is fully effective.
  5. Depending on the porosity of the stone, apply the product undiluted, wet on wet, evenly on the stone one or more times with a brush, mop, spray device, or lint-free cloth.
  6. Always treat the entire surface.
  7. Approximately 20 minutes after application, as the surface begins to dry, remove the excess product with a cloth. For polished surfaces, polish with a lambswool.
  8. Full effectiveness is reached after approximately 24 hours.
  9. Non-compliance with processing guidelines may lead to irreversible damage.
- 
1. Nettoyage : La surface devrait être propre, sèche et exempte de couches. Pour une utilisation en extérieur, assurez-vous que la pierre ne contient pas de sels nocifs (nitrates, sulfates, chlorure), car ils peuvent réduire la capacité d'absorption de l'imprégnation.
  2. Agiter avant l'usage.
  3. Pour vérifier l'usage, la profondeur de la couleur et l'efficacité, il est recommandé de prendre un échantillon.
  4. Température de traitement: 10°C à 25° degrés; éviter l'exposition directe au soleil et l'humidité jusqu'à ce que le produit soit entièrement efficace.
  5. En fonction de la porosité de la pierre, appliquez le produit non dilué, humide sur humide, uniformément sur la pierre une ou plusieurs fois avec un pinceau, une serpillière, un pulvérisateur ou un chiffon non pelucheux.
  6. Traiter toujours toute la surface.
  7. Environ 20 minutes après l'application, lorsque la surface commence à sécher, enlever l'excédent de produit avec un chiffon. Pour les surfaces polies, polir avec une laine d'agneau.
  8. L'efficacité totale est atteinte après environ 24 heures.
  9. Le non-respect des directives de traitement peut causer des dégâts irréversibles.
- 
1. Reiniging: het oppervlak moet zuiver, droog en vrij zijn van andere producten. Bij buitengebruik moet erop gelet worden dat de steen geen schadelijke zouten bevat (nitraten, sulfaten, chloride), aangezien deze het opnamevermogen van de impregnering verminderen.
  2. Schudden voor gebruik.
  3. Om het gebruik, de kleurverdieping en de werkzaamheid te controleren, wordt aangeraden een proefstuk te nemen.
  4. Verwerkingstemperatuur: 10°C tot 25°C; directe zoninwerking en vochtinwerking vermijden totdat het product volledig werkzaam is.
  5. Afhankelijk van de poreusiteit van de steen één- of meerdere malen het product onverdund, nat op nat, gelijkmatig op de steen aanbrengen met een penseel, mop, spuittoestel of pluisvrije doek.
  6. Behandel steeds het volledige oppervlak.
  7. Ongeveer 20 minuten na het aanbrengen, als het oppervlak begint te drogen, het overtollige product met een doek verwijderen. Bij gepolijste oppervlakken met een lamsvel napolijsten.
  8. De volle werkzaamheid wordt bereikt na ongeveer 24 uur.
  9. Het niet naleven van de verwerkingsrichtlijnen kan leiden tot onherstelbare schade.



# ELMINA<sup>®</sup>

*môj životný štýl*

---

ELMINA Bratislava  
OC Lightpark  
Račianska 90, Bratislava  
tel.: 02/634 522 59  
elmina@elmina.sk  
**www.elmina.sk**

Ceny vr. DPH

ELMINA<sup>®</sup>  
*môj životný štýl*

ELMINA Bratislava | OC LIGHTPARK | Račianska 90 | Bratislava

**www.elmina.sk** | [elmina@elmina.sk](mailto:elmina@elmina.sk) | +421 910 919 711

Ceny vr. DPH