

UMBROSA

UNIQUE SHADE DESIGN

ELMINA[®]

môj životný štýl

ELMINA Bratislava | OC LIGHTPARK | Račianska 90 | Bratislava

www.elmina.sk | elmina@elmina.sk | +421 910 919 711

CENY BEZ DPH

ELMINA Bratislava | OC LIGHTPARK | Račianska 90 | Bratislava
www.elmina.sk | elmina@elmina.sk | +421 910 919 711
CENY BEZ DPH

An original idea makes design distinctive
but function makes it work.

UMBROSA

UMBROSA

Umbrosa Unique Shade Design



UNIQUE SHADE DESIGN,
THERE IS NO BETTER
WAY TO DESCRIBE
WHERE UMBROSA
STANDS FOR.

Umbrosa offers stylish and sustainable shade solutions for the residential and the project market.

ALL PRODUCTS ARE DEVELOPED AND PRODUCED IN BELGIUM.

The shade solutions by Umbrosa are a clear statement of both elegance and understated simplicity, and that in combination with a never seen way of ergonomics that puts 'easy to use' to a higher dimension.

Umbrosa chooses very consciously to work with the best international designers and to produce exclusively in Belgium. All of this ensures long lasting shade, year after year. Our umbrella collections are exported to more than 90 countries and are used around the world on the most beautiful terraces and by the most famous hotel groups.

__UX COLLECTION__	04
Versa UX	06
Icarus UX	18
Eclisum UX	22
Made in Belgium	26
Nano UX	28
Paraflex UX	34
Infina UX	36
__PX COLLECTION__	38
__STANDARD COLLECTION__	40
Spectra	42
Icarus	54
Design team	58
Paraflex	60
Infina	64
__SHADE SAILS__	70
Ingenua	72
Reference projects	76
Overview collections	84

Index



__UX COLLECTION **Versa UX** | Full Black

UMBROSA

UX collection

The UX collection does not follow the standard rules. Each umbrella is a unique combination of color, shape and material, and has ultimate ease of use and perfect ergonomics. The umbrellas refine the look of any outdoor setting: discreet luxury for those looking for that little bit extra.

The UX concepts are designed as a package and are also offered as such. Canopy, frame and umbrella base together create one unique concept.

Umbrosa has 6 UX collections:

- __Versa UX
- __Nano UX
- __Icarus UX
- __Eclisum UX
- __Infina UX
- __Paraflex UX



Note: Check the Umbrosa pricelist for the collections available in your country.



__UX COLLECTION

Versa UX

Full Black

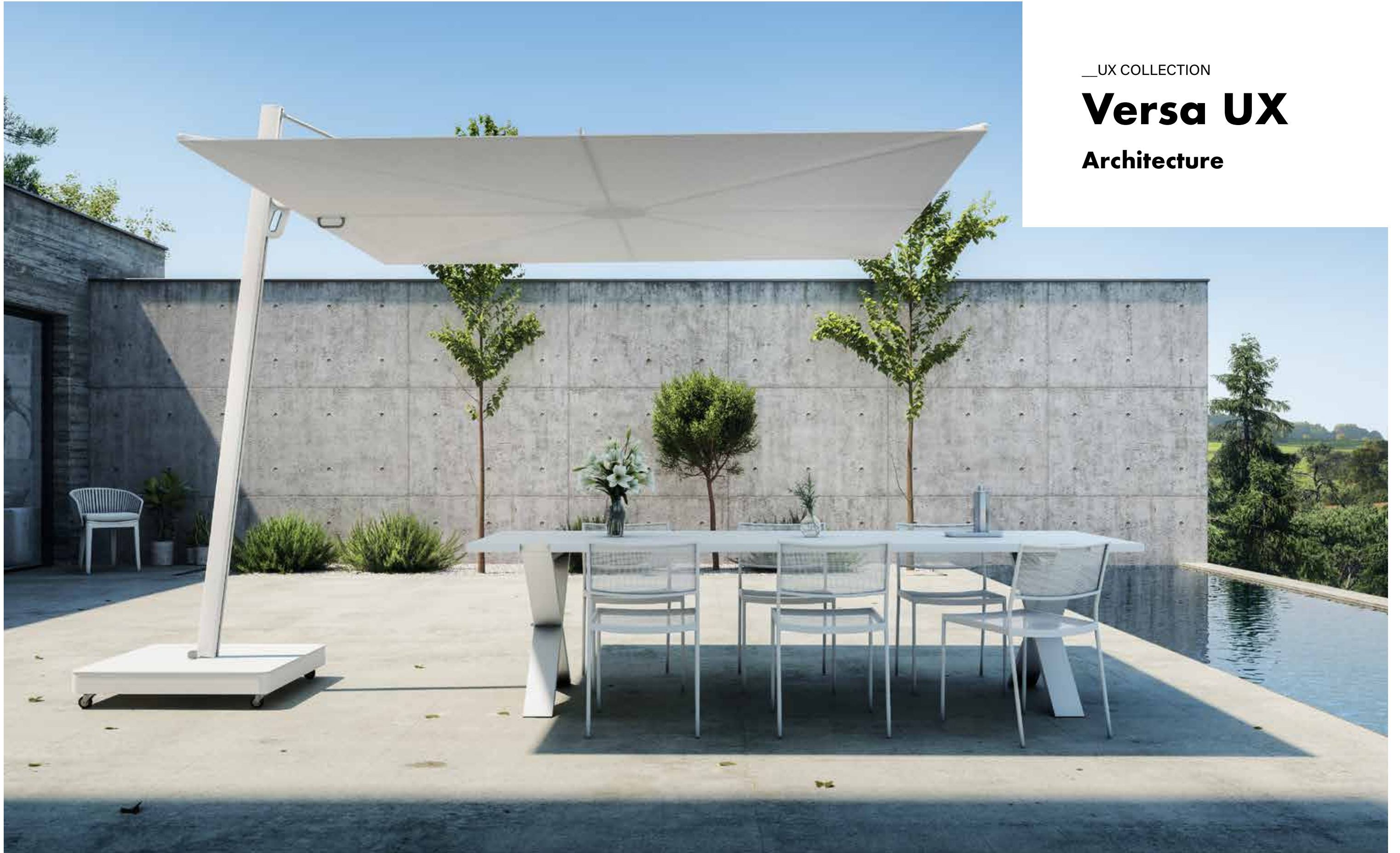

__UX COLLECTION

Versa UX

Architecture



__UX COLLECTION **Versa UX** | Architecture



__UX COLLECTION

Versa UX

Sand

__UX COLLECTION

Versa UX

Safari

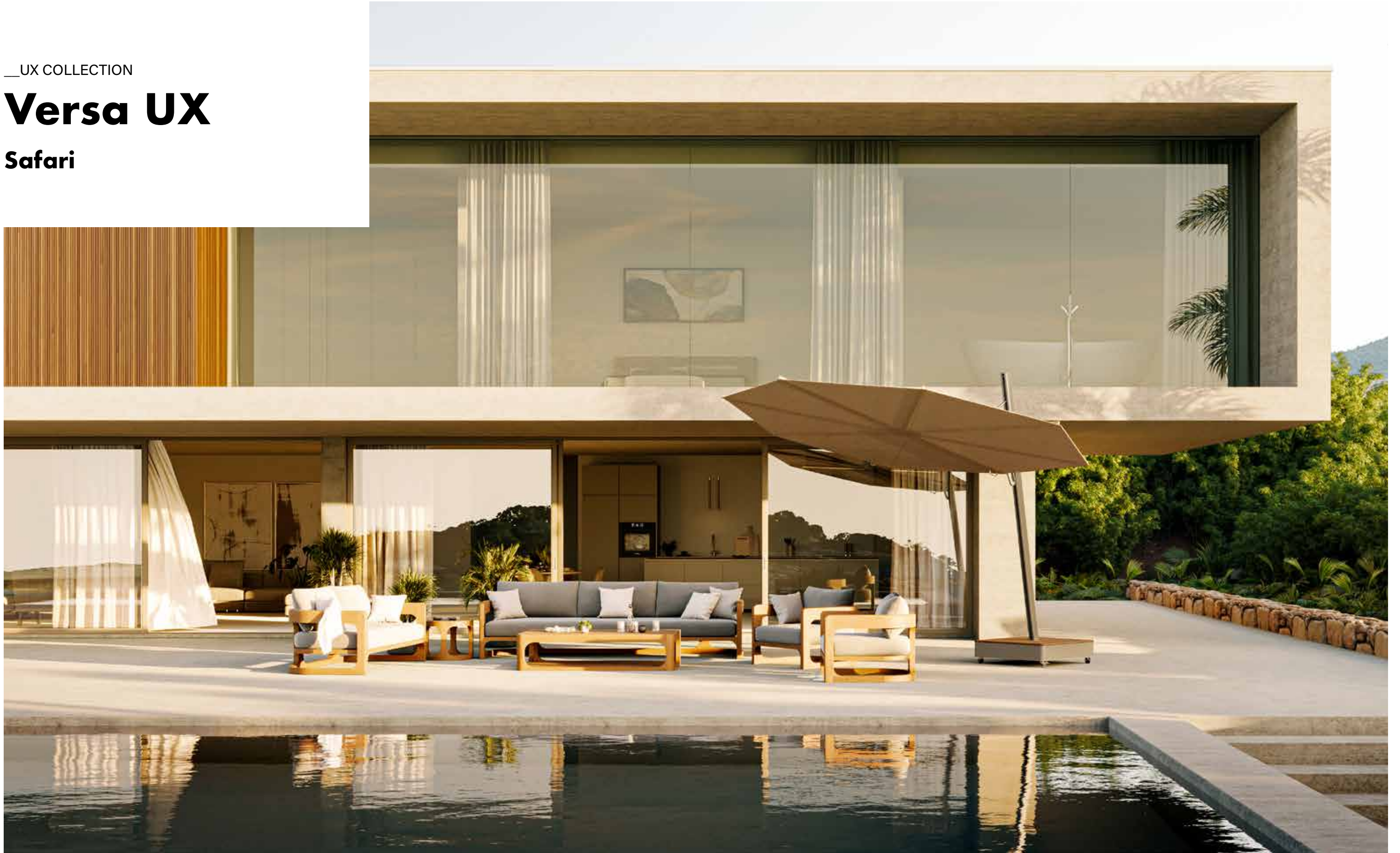

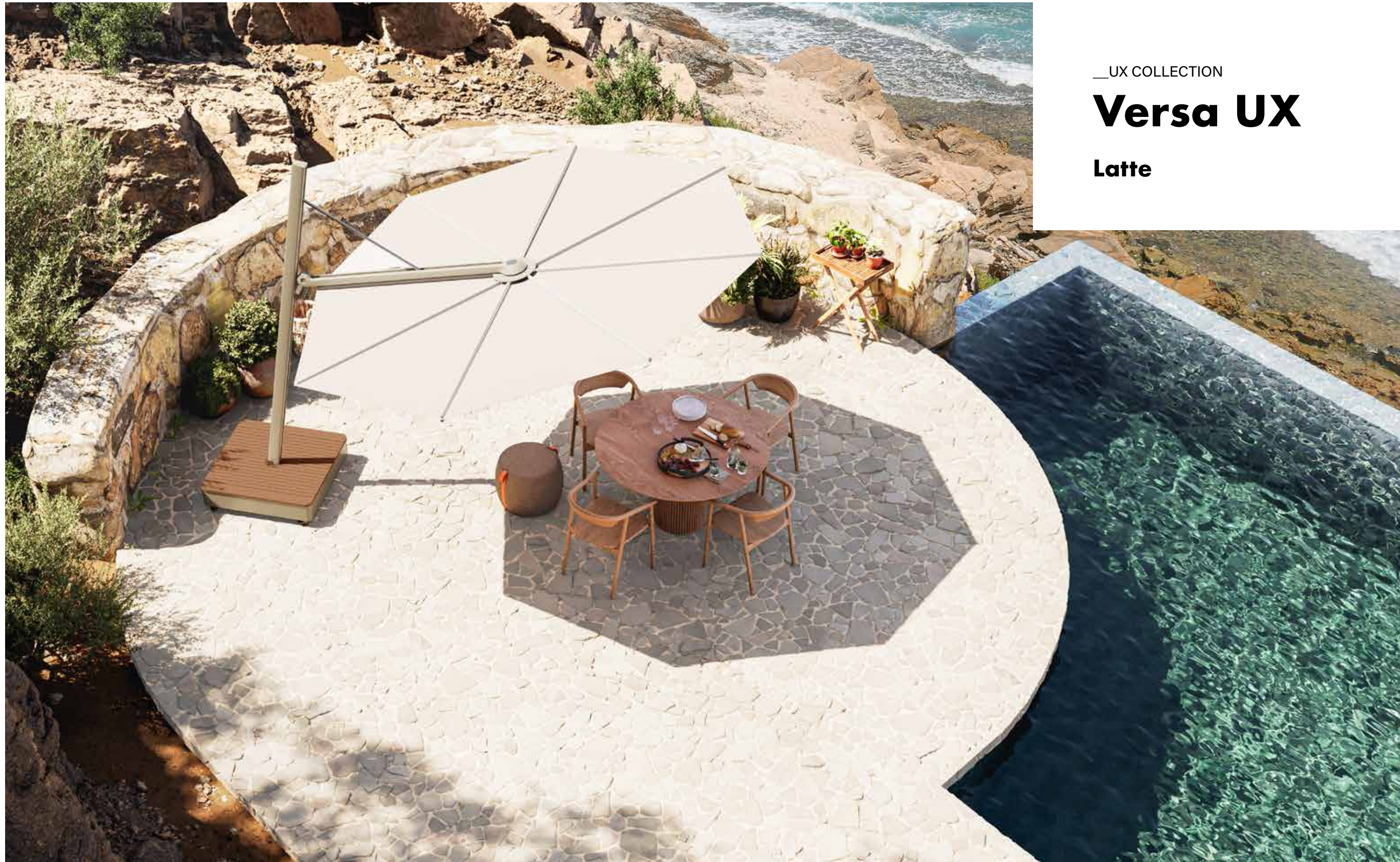

__UX COLLECTION

Versa UX

Latte

__UX COLLECTION

Icarus UX

Sand

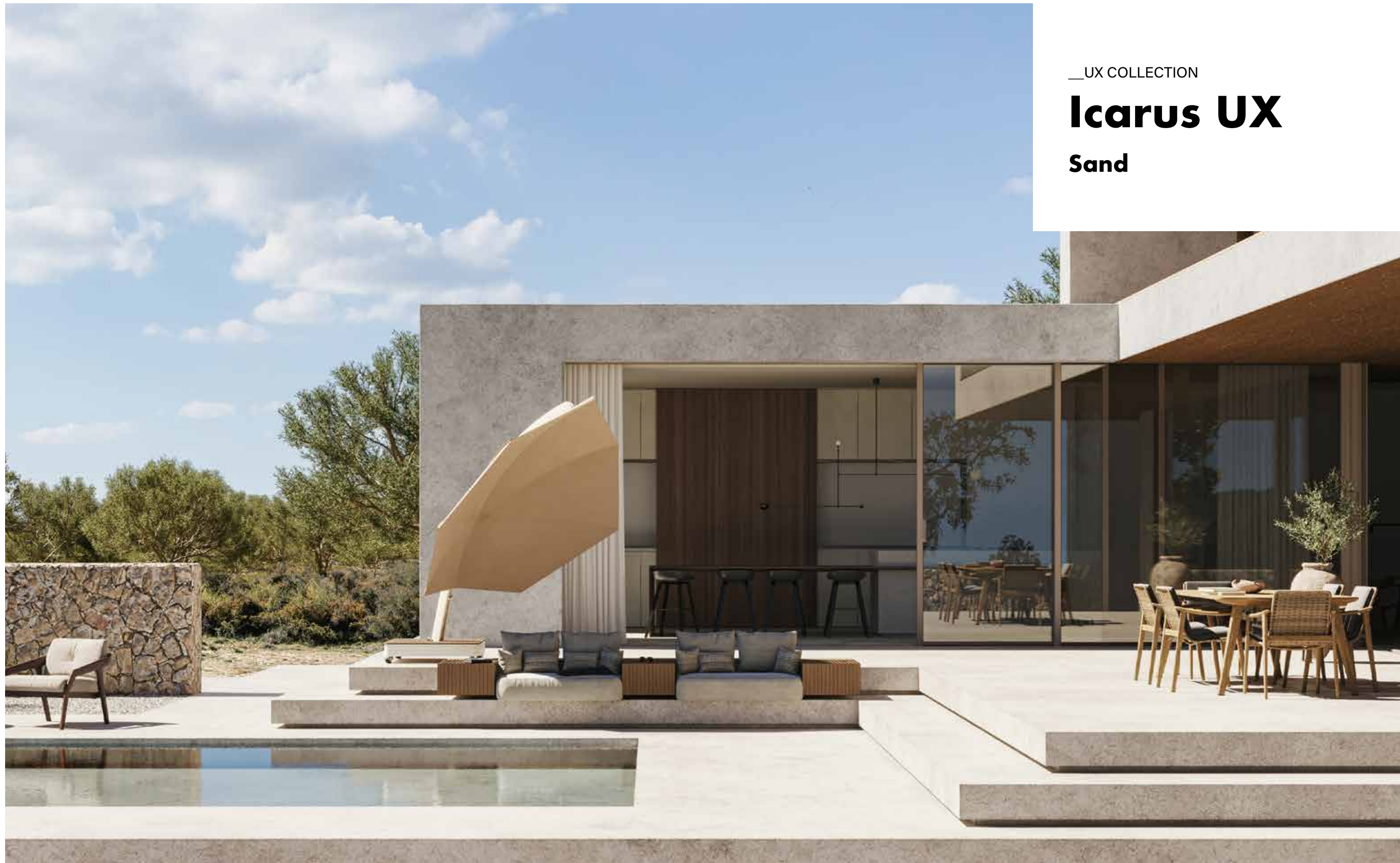

__UX COLLECTION

Icarus UX

Full Black

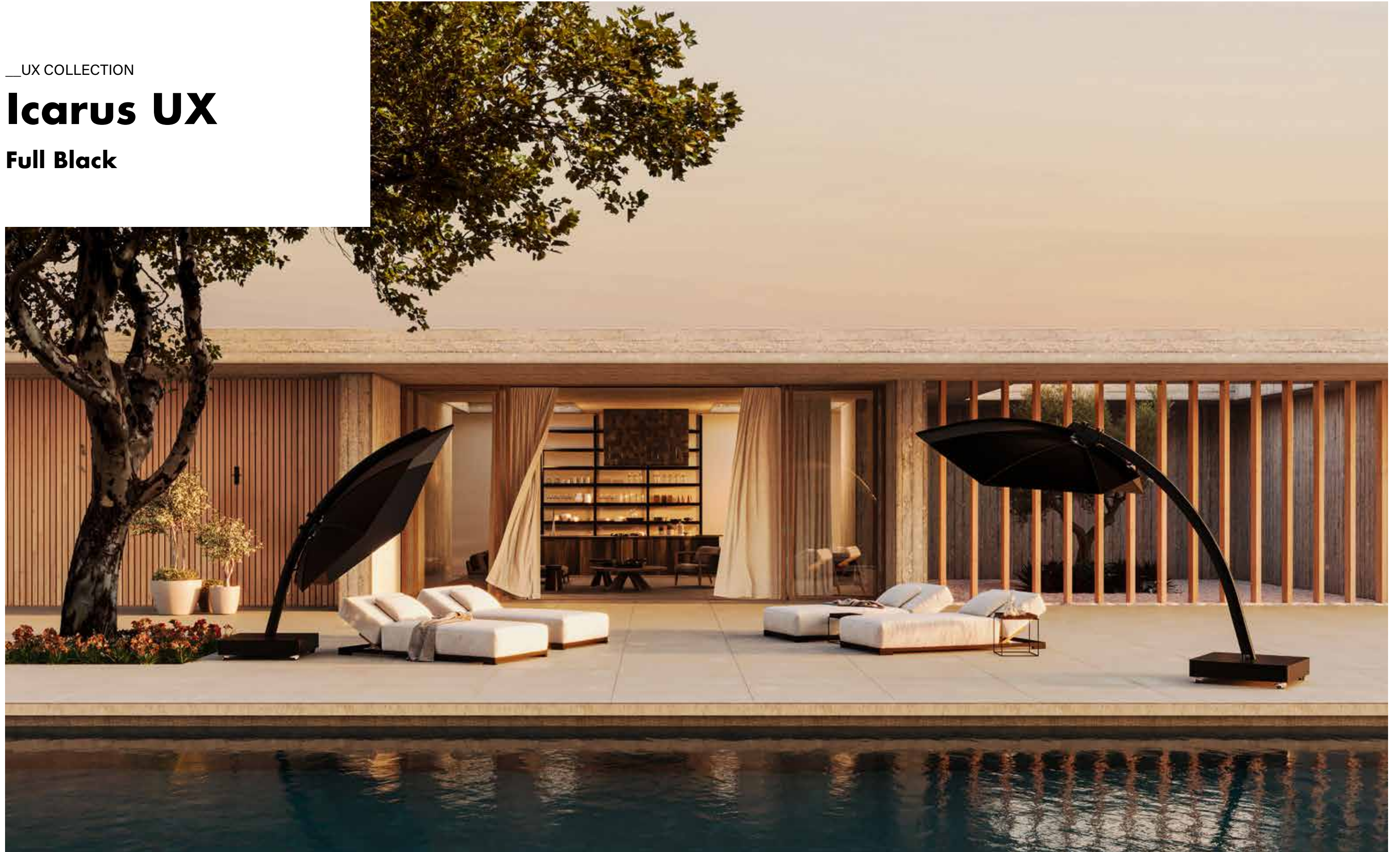

__UX COLLECTION

Eclisum UX

Architecture



__UX COLLECTION

Eclisum UX

Full Black



Made in Belgium

UMBROSA TOGETHER WE ARE 1 TEAM AND 1 BIG UMBROSA FAMILY!



Each Umbrosa product, before it reaches you, has passed through many hands! Our parasols and shade sails are repeatedly submitted to the sharp eyes of our quality controllers during the production process.

The production starts with our **seamstresses**, who check the fabrics and then process them with utmost care into a finished canopy or shade sail. All canopies are hand-stitched one by one in our sewing department.

Our **assembly team** hand-mounts all frames and bases. Our logistics department picks the goods, packs them carefully, and makes sure they get to you safely.

Our **design team** is continuously working on re-thinking existing collections and designing new parasols.



__UX COLLECTION

Nano UX

Architecture

__UX COLLECTION

Nano UX

Full Black





__UX COLLECTION **Nano UX** | Architecture

__UX COLLECTION **Nano UX** | Full Black



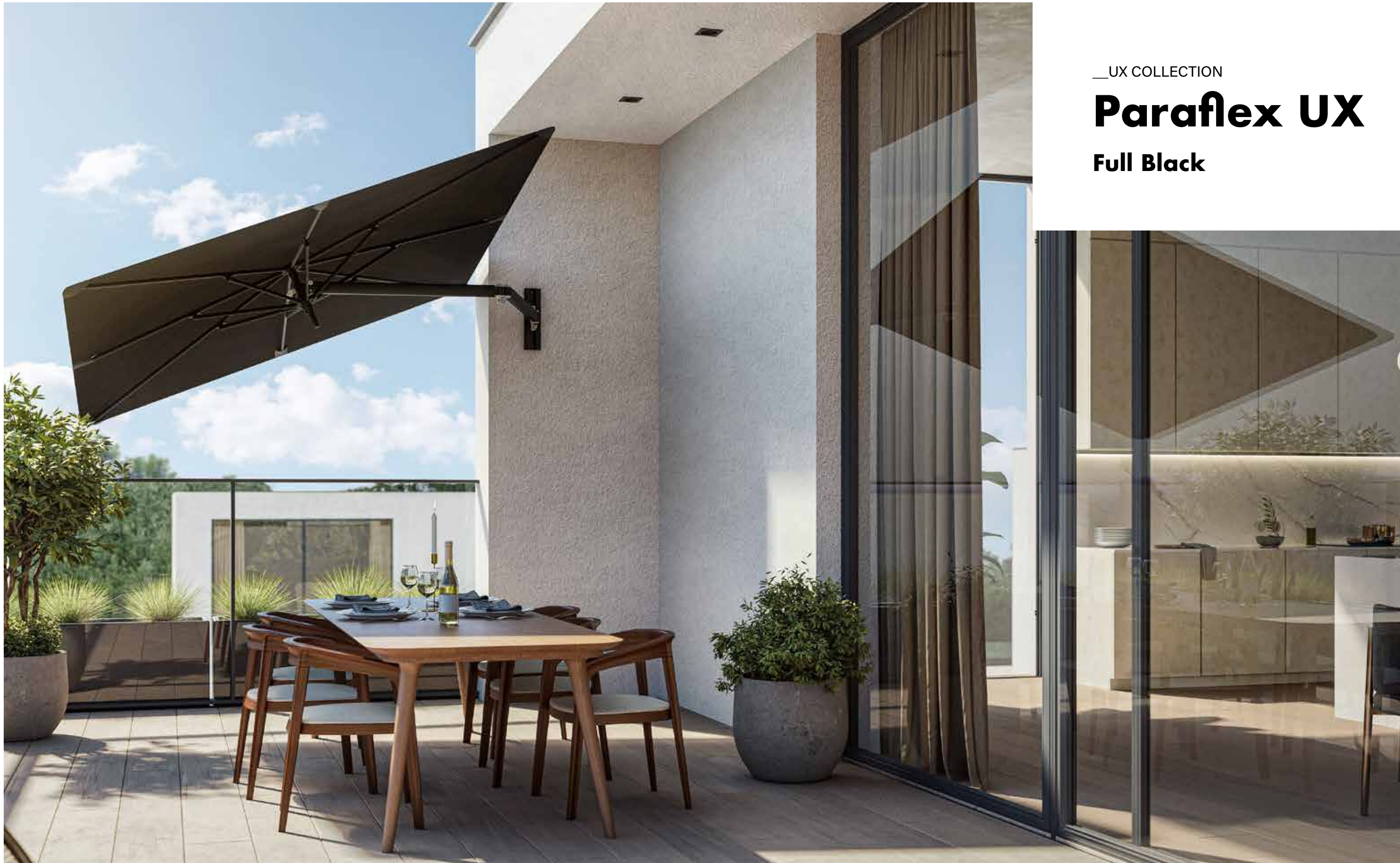

__UX COLLECTION

Paraflex UX

Full Black



__UX COLLECTION

Infina UX

Latte



__PX COLLECTION **Versa PX**

UMBROSA

PX collection

PX stands for "Personal Experience", create your own parasols according to your personal taste, with the highest level of finishing and the unique Versa features. The **Versa PX** collection allows you to freely combine the shape of the canopy (square or round), the color of the frame, the canopy and the parasol base. Configure your Versa PX parasol on our website!



__STANDARD COLLECTION **Icarus** | Conrad, Koh Samui, Thailand

UMBROSA

Standard collection

The Umbrosa standard collection consists of 4 collections where each model is available in 13 different canopy colors. This collection contains a range of wall mounted umbrellas, center pole umbrellas and cantilever umbrellas.

Umbrosa has 4 standard collections:

- __Spectra
- __Icarus
- __Paraflex
- __Infina



Note: Check the Umbrosa pricelist for the collections available in your country.



__STANDARD COLLECTION

Spectra

Mono

__STANDARD COLLECTION **Spectra Mono** | Hilton Como, Italy

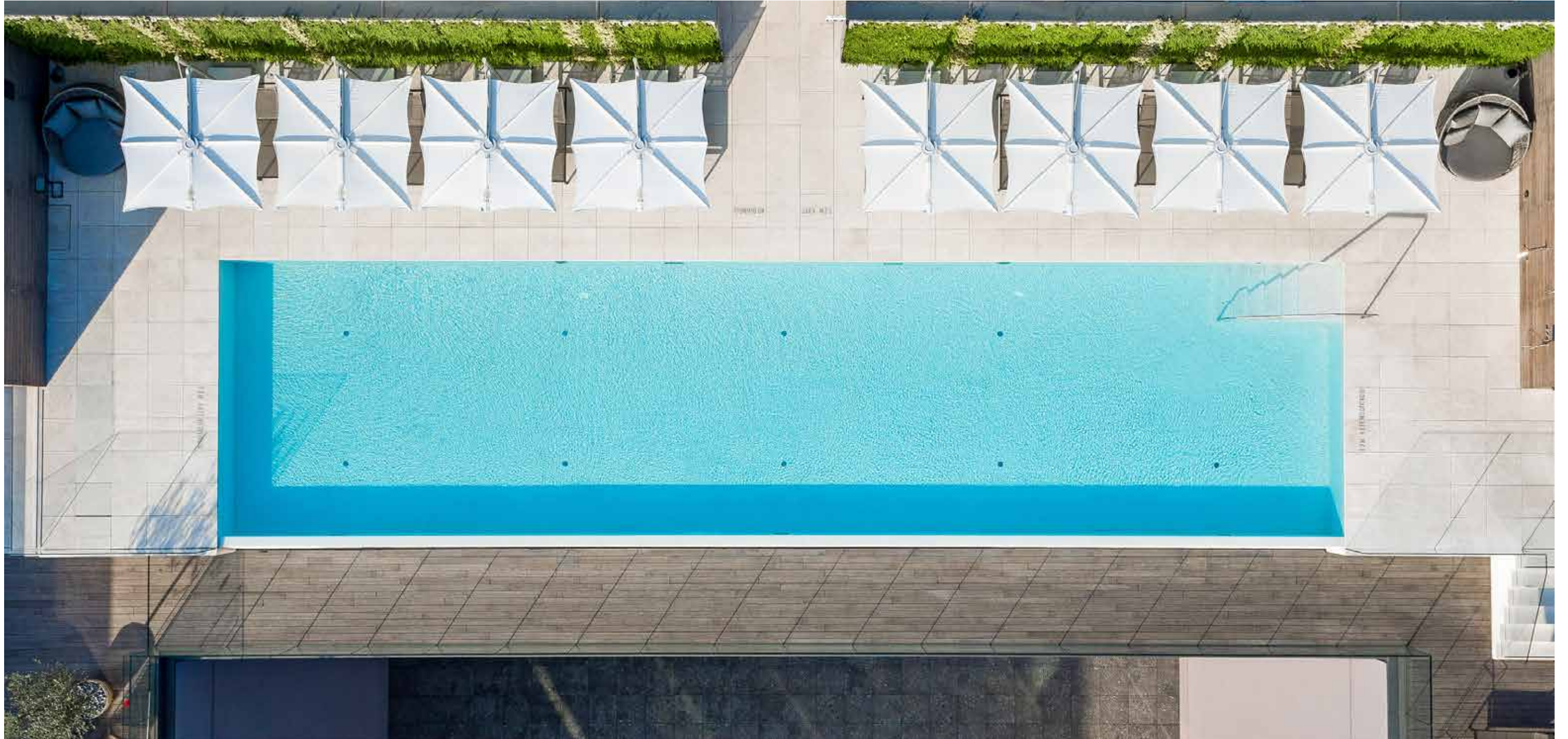



__STANDARD COLLECTION **Spectra Mono** | Beachclub KAH, Marbella, Spain

__STANDARD COLLECTION **Spectra Mono** | Eagles Villas, Greece



__STANDARD COLLECTION **Spectra Mono**



__STANDARD COLLECTION

Spectra

Duo

__STANDARD COLLECTION **Spectra Duo** | Ukraine



__STANDARD COLLECTION **Spectra Duo** | Capri, Greece

__STANDARD COLLECTION **Spectra Mono & Duo** | Baker's Cay Resort Key Largo Florida, United States





__STANDARD COLLECTION

Icarus

__STANDARD COLLECTION **Icarus** | La Casa di Mare, Greece



It's all about timeless design and sustainability

The R&D team of Umbrosa develops new products and at the same time constantly seeks to improve the current collections. Sustainability is a verb for us that keeps us busy on a daily basis. **Design trends are important, but timeless design is what we strive for at Umbrosa.**

We are all becoming increasingly aware of climate and sustainability. Umbrosa buys as many components as possible locally in order to shorten the chain, establish good communication and secure reliable quality. The fact that we confection and assemble in Belgium adds to our efforts to reduce our ecological footprint and to increase our supreme quality level. We will not support a throwaway society. Therefore, our products are thoroughly tested and we carry an extensive range of spare parts. We also try to create designs that touch people and that establish an emotional bond that lasts.



Umbrosa is also part of the growing importance of healthier and safer environments with cleaner air. This translates into more organic gardens with lots of flowers, trees and wild plants along with design umbrellas that protect your skin and go hand in hand with the outdoor experience.

The garden has become an extra room to the house, the difference between indoor and outdoor is fading. Now more than ever we search for a feeling of security and cosiness in our gardens.

UMBROSA

Design Team:

Tore Bleuzé | Pieter Willemyns | Alien Schoenaers | Lennart Delporte

__STANDARD COLLECTION

Paraflex

Wall & Mono



__STANDARD COLLECTION **Paraflex Wall** | Ludwig van, Wien



__STANDARD COLLECTION

Infina

Villa Ama, Saint-Tropez, France © Tom Claeren

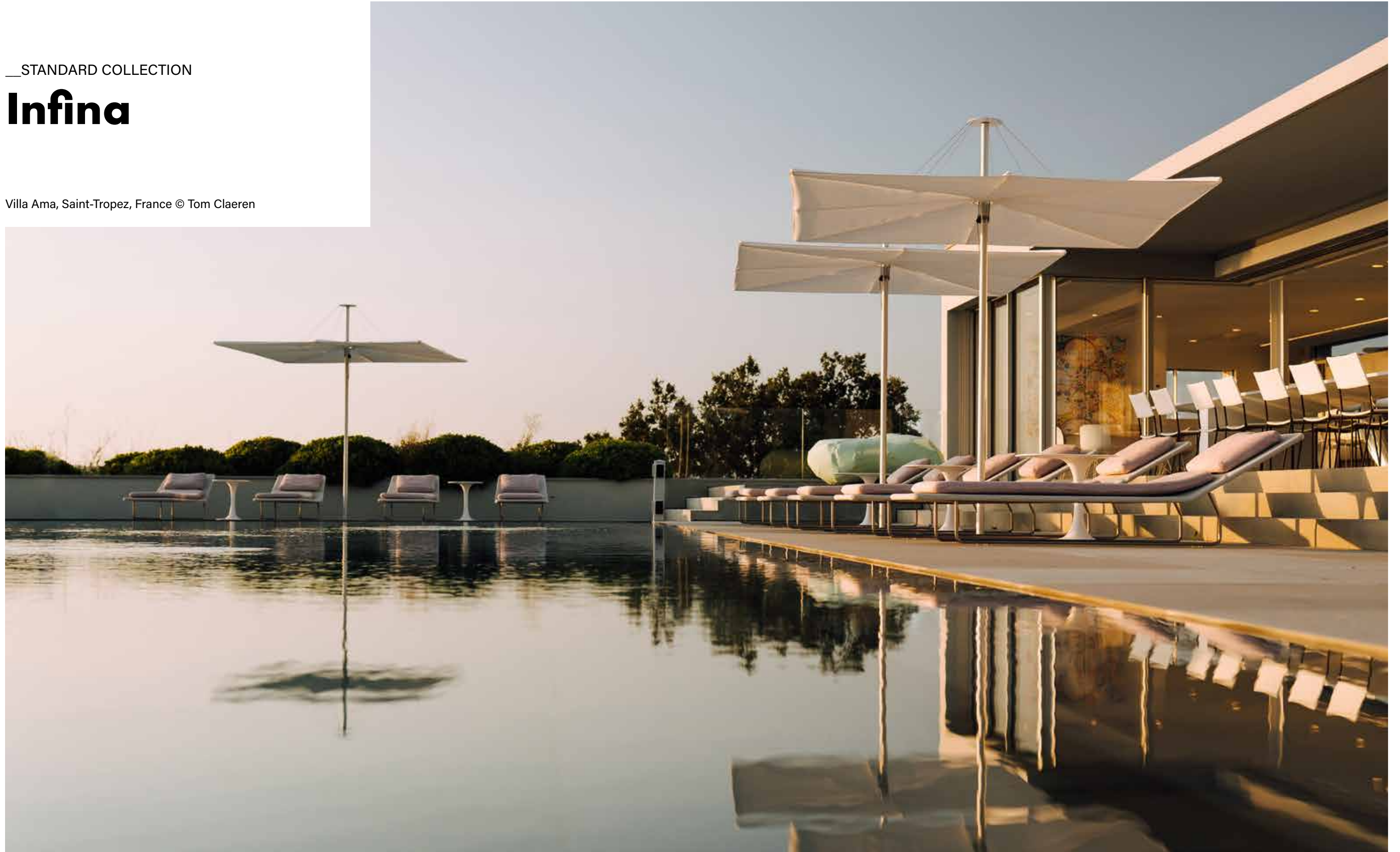

__STANDARD COLLECTION **Infina** | Pic du Midi



__STANDARD COLLECTION **Infina** | Villa Volterra, Toscane

__STANDARD COLLECTION **Infina** | Black





__SHADE SAILS **Ingenua**

UMBROSA

Shade sails

Even when larger areas have to be put in the shade, Umbrosa offers an easy solution. Thanks to the ingenious sliding mechanism of Ingenua, you can easily adapt the sail to the circumstances and the environment. The simple lines and modern shapes of Ingenua shade sails are combined with an excellent performance in terms of wind-resistance.



Note: Check the Umbrosa pricelist for the collections available in your country.

__SHADE SAILS **Ingenua** | Jumeirah, Maldives

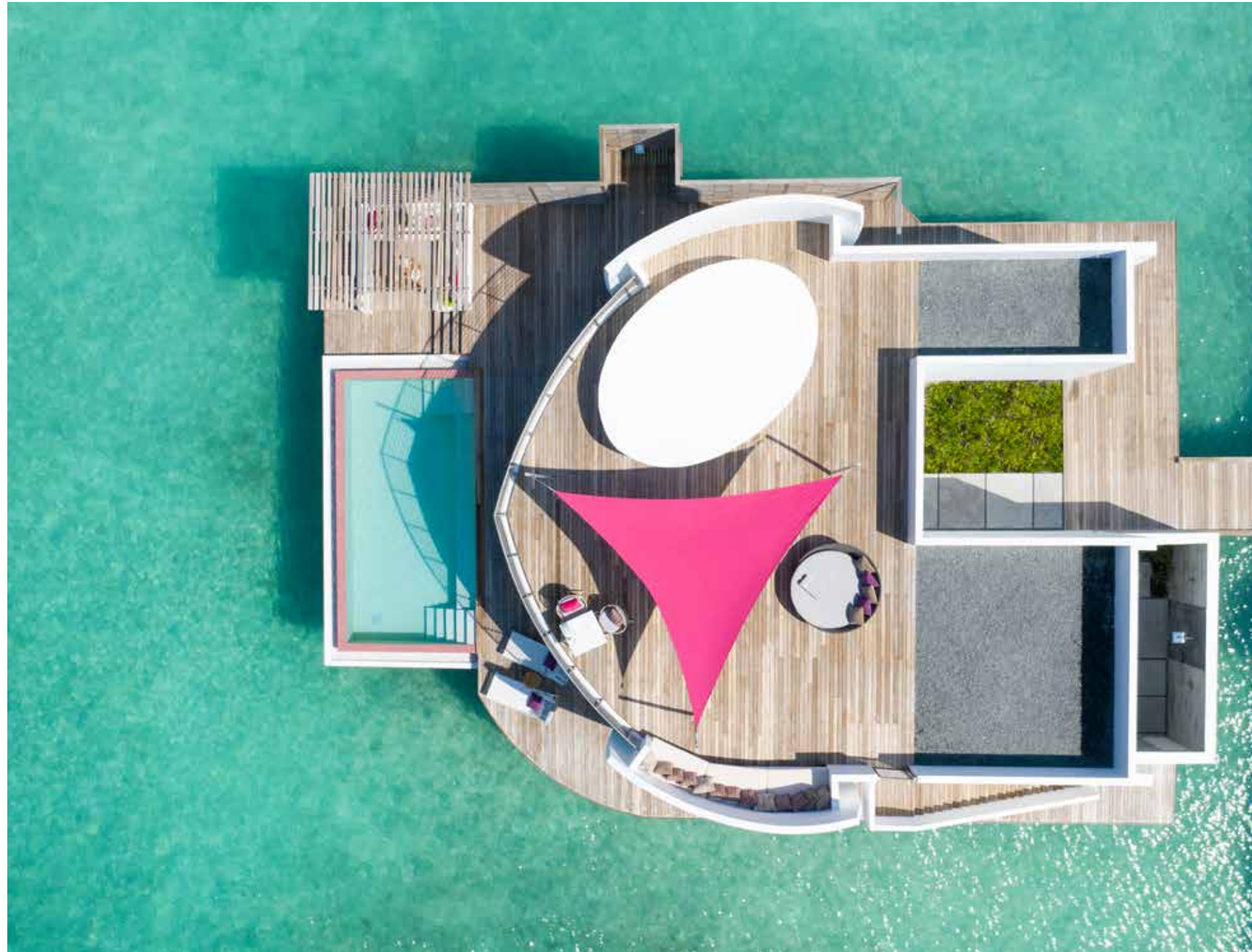

__SHADE SAILS **Ingenua** | Velassaru Resort, Maldives



__SHADE SAILS **Ingenua**

__SHADE SAILS **Ingenua**





UMBROSA

Reference projects

You can play with size, color of fabric, color of pole, base,... anything to make sure the umbrellas fit the rest of the outdoor furniture and atmosphere or even comply with the interior.

All products from our 'standard collection' are available per piece. All other product variations have minimum order quantities. Contact your Umbrosa dealer for more information.



__REFERENCE PROJECTS **Infina custom**



__REFERENCE PROJECTS **Infina custom** | Bonhommes, Belgium

__REFERENCE PROJECTS **Infina custom** | Bonhommes, Belgium



__REFERENCE PROJECTS **Eclisum custom** | Hard Rock Café, Madrid



__REFERENCE PROJECTS **Infina custom** | Four Seasons Ritz, Lisbon

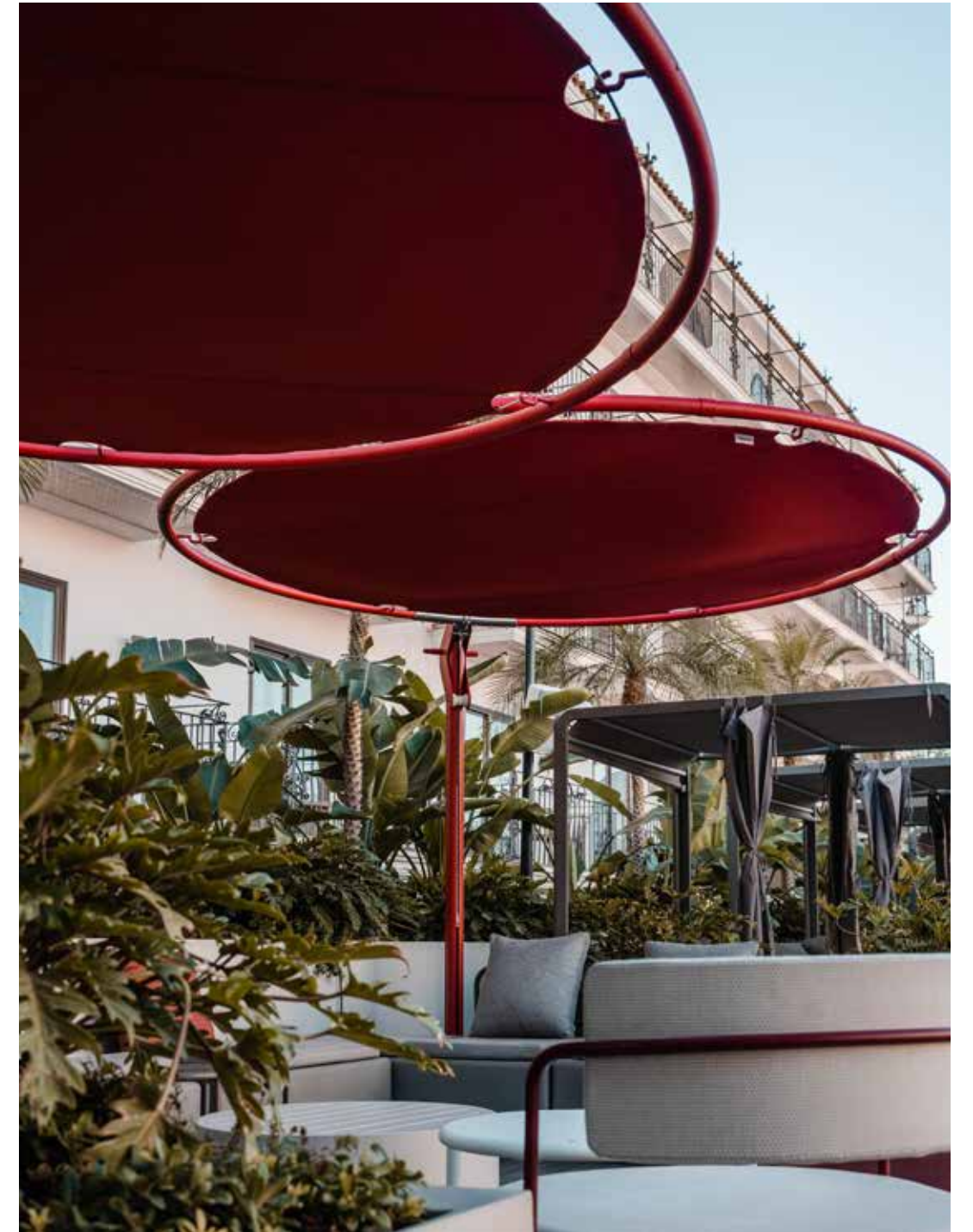

__REFERENCE PROJECTS **Eclisum custom** | Hard Rock Café, Marbella

Overview UX Collection

The Umbrosa UX collection currently consists of 13 unique parasols. The parasols are only available in the combination as shown here.

Versa UX Canopy 3 x 3 m | 9'10" x 9'10" (square)

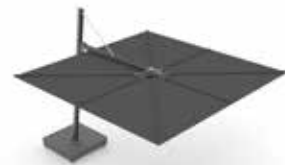

Full Black



Architecture



Sand

Versa UX Canopy 3.5 m | 11'6" (round)



Latte



Safari

Eclisum UX Canopy 3 m | 9'10"



Full Black



Architecture

Nano UX Canopy 2.5 x 2.5 m | 8'2" x 8'2"



Full Black



Architecture

Icarus UX Canopy 3 m | 9'10"



Sand

Icarus UX Canopy 3 m | 9'10"



Full Black

Paraflex UX WALL & MONO

Canopy 2.3 x 2.3 m | 7'6.6" x 7'6.6" - 1.9 x 1.9 m | 6'3" x 6'3"



Full Black

Infina UX Canopy 3.5 m | 11'6" (round)



Latte

Note: Check the Umbrosa pricelist for the collections available in your country.

Overview PX Collection

Choose your combination: color frame | canopy | base.

MODEL - VERSA PX

Square: 9'10" | Round: 11'6"

OPTIONS COLOR FRAME



OPTIONS CANOPY



OPTIONS BASE

Topplate

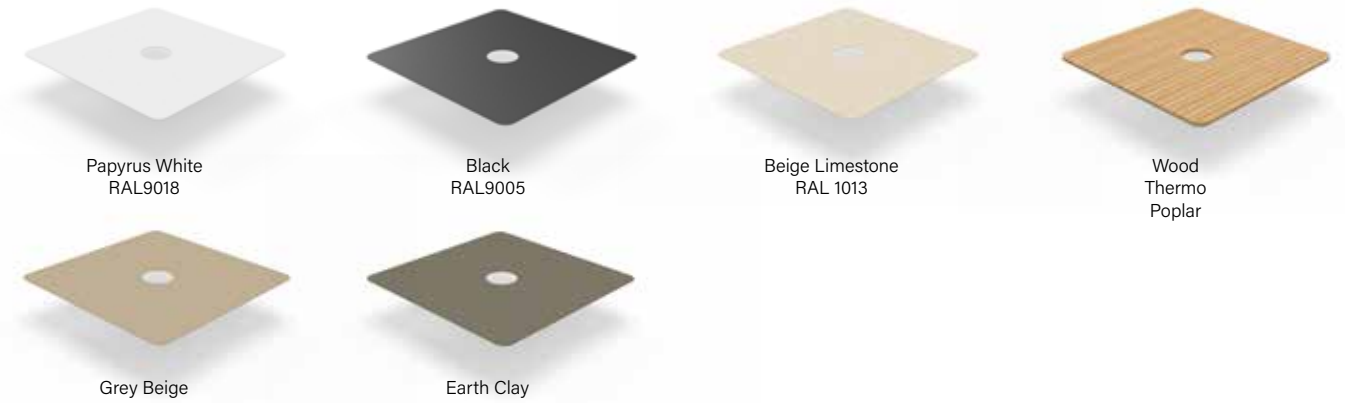

Frame



Some possible combinations



Note: Check the Umbrosa pricelist for the collections available in your country.

Overview Standard Collection

The Umbrosa standard collection consists of 4 collections where each model is available in 13 different canopy colors.

Spectra SQ 2.5m & 3m | 8'2" & 9'10" - DUO 2.5 x 5.4m | 8'2" x 17'9" - MULTI 5.4 x 5.4 m | 17'9" x 17'9"

Finish:

- Alu
- Black (RAL 9005)

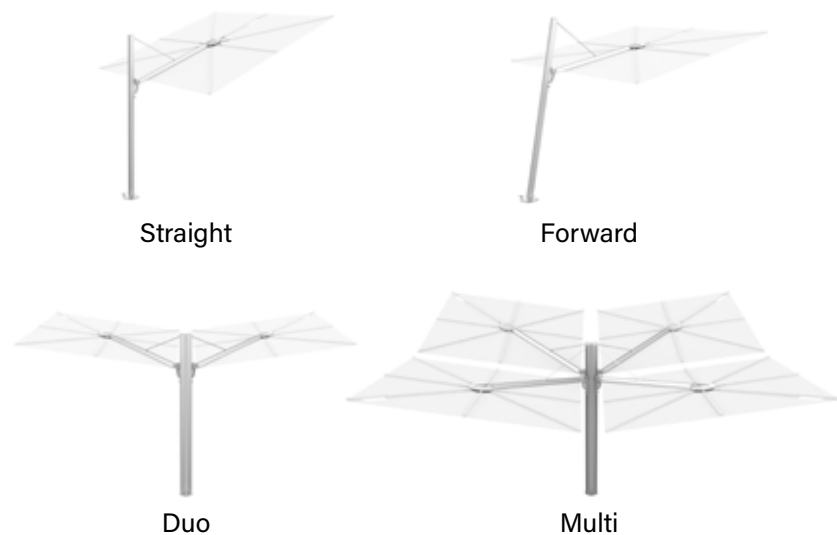

Icarus 3 x 3m | 9'10" x 9'10"

Finish:

- Alu



Nata RO 2.8 m & 3.2 m | SQ 2.0 m & 2.3 m - RO 9'2" & 10'6" | SQ 6'7" & 7'7"

Finish:

- Black (RAL 9005)
- Beige Limestone (RAL 1013)



Paraflex SQ 1.9m & 2.3m | RO 2.7m & 3m - SQ 6'3" & 7'6.6" | RO 8'10" & 9'10"

Finish:

- Alu



Infina SQ 3m | RO 3m - SQ 9'10" | RO 9'10"

Finish:

- Alu
- Black (RAL 9005)



Note: Check the Umbrosa pricelist for the collections available in your country.

Overview Shade sails

The Ingenua sun shade sails from Umbrosa are the perfect solution to provide your terrace or a part of your garden with shade.

Ingenua 4 x 4 x 4m | 13'1" x 13'1" x 13'1" | 5 x 5 x 5m | 16'5" x 16'5" x 16'5" | 4 x 5 x 6.4m | 13'1" x 16'5" x 21' | 4 x 4m | 13'1" x 13'1"
4 x 3m 9'10" x 13'1" | 5 x 3m | 9'10" x 16'5" | 5 x 4m | 13'1" x 16'5"

Finish:

- Alu
- Black (RAL 9005)



Triangle



Square



Rectangle



Note: Check the Umbrosa pricelist for the collections available in your country.

Overview Colors

FRAME COLORS



FABRIC COLORS

Solidum



Colorum

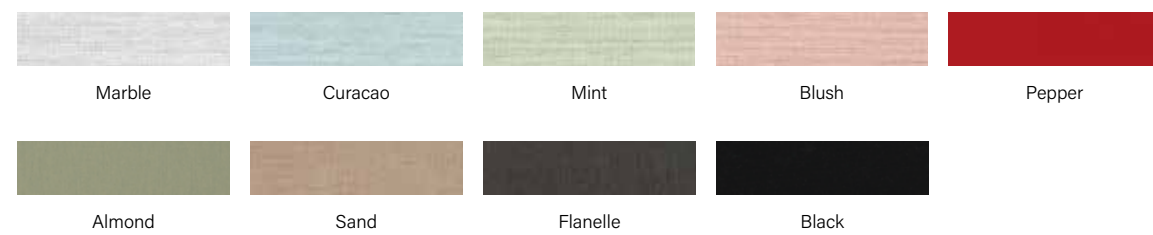

Umbrosa has 2 collections of parasol fabrics.

The **Solidum** colors are standard colors. The fabric is 100% Acryl and is made by Dickson.

The **Colorum** collection contains the more exclusive colors. These fabrics, also 100% Acrylic, are manufactured by Dickson (Sunbrella) or Tuvatextil (Agora).

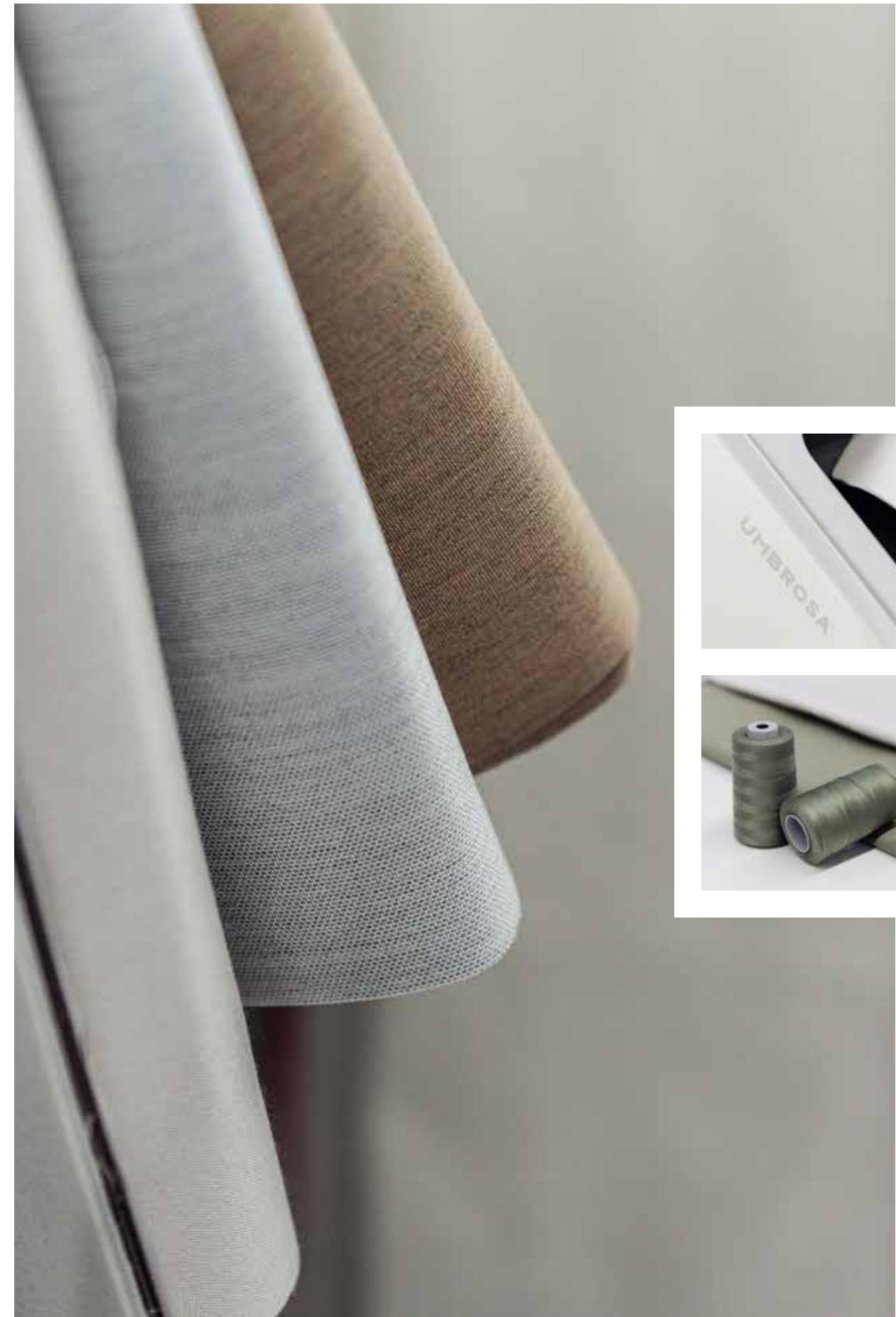

Overview Mounting options

Permanent mounting

Hard ground



ROUND SUPPORT TYPE 1
Paraflex Mono



ROUND SUPPORT TYPE 2
Infina (UX) | Nano UX | Nata



ROTATION SUPPORT -80
Spectra 80° | Versa UX | Icarus (UX)



ROTATION SUPPORT -90
Spectra 90° | Eclisum UX

Soft ground



INGROUND ANCHOR TYPE 1
All collections except Ingenua



INGROUND ANCHORAGE -80
Ingenua



INGROUND ANCHORAGE -90
Ingenua

Mobile bases



FLAT BASE
Infina (UX)
73x73x8.5cm | 28 3/4" x 28 3/4" x 3 3/8"

- Alu
- Black (RAL 9005)



FLAT BASE WOODEN TOPPLATE
Thermo Poplar
Infina UX Latte
77x77x11cm | 30 1/2" x 30 1/2" x 4 1/8"



MEDIUM TILE BASE
Paraflex Mono | Infina | Nano UX
88.6x88.6x17.5cm | 34 7/8" x 34 7/8" x 6 7/8"

- Alu
- Papyrus White (RAL 9018)
- Black (RAL 9005)



LARGE TILE BASE STANDARD
Paraflex Duo & Multi | Spectra ALL | Icarus
88.6x88.6x22cm | 34 7/8" x 34 7/8" x 8 5/8"

- Alu
- Black (RAL 9005)



LARGE TILE BASE UX
Versa UX | Eclisum UX
88.8x88.8x22cm | 34 7/8" x 34 7/8" x 8 5/8"

- Papyrus White (RAL 9018)
- Black (RAL 9005)



LARGE TILE BASE UX WOODEN TOPPLATE
Thermo Poplar
Versa UX Sand | Icarus UX Sand | Versa UX Latte | Versa UX Safari
88.8x88.8x24cm | 34 7/8" x 34 7/8" x 9 3/8"

- Earth Clay
- Grey Beige
- Beige Limestone (RAL 1013)

Please find all the information on Umbrosa's product range below!

Scan our demo movies, tutorials or technical sheets and you're ready to sell and use our umbrellas.

Demo movies



Versa UX



Icarus (UX)



Eclisum (UX)



Nano UX



Paraflex (UX)



Infina (UX)



Spectra



Ingenua



Nata

Playlist tutorials



Technical sheets



UMBROSA
UNIQUE SHADE DESIGN

ELMINA.
mój životný štýl

ELMINA Bratislava | OC LIGHTPARK | Račianska 90 | Bratislava
www.elmina.sk | elmina@elmina.sk | +421 910 919 711
CENY BEZ DPH

CENNÍK 2025

Shade sails

CENY BEZ DPH

Valid from October 1, 2024

Presented by

UMBROSA

ELMINA[®]
můj životní styl





UMBROSA COMPANY

umbrosus, a, um (adi.) 1. Shady, leafy, full of shade, shaded - Umbrosa embodies innovative shade solutions with a young and dynamic appeal. Our umbrella collections exude class, flexibility, and thoughtful design. They ensure protection from the sun in an effortless and stylish manner. At Umbrosa, we make a statement of elegance and simplicity. We collaborate with leading international designers and proudly produce under the label 'Made In Belgium'. Our team of designers and creative minds pays special attention to the unique character and bold creativity of each design.

Quality and sustainability are essential values in our production process, resulting in long-lasting shade year after year. Our umbrella families have become renowned worldwide on the most breathtaking terraces and among the most prestigious hotel groups in over 90 countries. Nature is an endless source of inspiration that constantly stimulates us. Just as trees and plants provide shade in a unique way, we aim to offer shade solutions to our customers in that same distinctive manner.

Umbrosa strives to develop versatile and innovative shade creations that are far removed from the traditional umbrella. As the unique umbrella design brand for both residential and commercial use, Umbrosa offers affordable prices without compromising on style and quality.

TEAM

At Umbrosa, customers experience the perfect combination of flexibility and personal service, typical of a small-scale organization, while enjoying the expertise and reputation of a global player, as evidenced by our numerous international references. Our loyal customers benefit from the advice and guidance of a dedicated contact person, who's full of passion and knowledge and ready to assist them. With our team of 40 people based in Belgium, we master the entire production process, from innovative product development to successful commercialization. We take pride in the fact that all our products, ranging from Paraflex and Ingenua to Icarus, Spectra, Infina, and the UX collection, are manufactured with care and craftsmanship in Belgium: a guarantee of sustainable Belgian quality! April 2022 marks an exciting milestone for Umbrosa! Not only have we expanded our sales activities to the United States, but we are also delivering directly from our brand-new warehouse in Baytown, TX. We can't wait to conquer the American market, which is filled with unprecedented potential for Umbrosa. Get ready, USA, Umbrosa is coming!

VISION AND MISSION STATEMENT

Vision

Umbrosa wants to provide all terraces and gardens around the world with Unique Shade Solutions.

Mission

To manufacture high-end shade solutions in Belgium, that offer the optimal user experience, by designing unique, innovative and sustainable products, that have an impact on outdoor living.

Values

Passion | Communication | Perfection | Personal growth



DESIGNERS

Umbrosa distinguishes itself by a daring design that is both accessible and playful. To obtain this, we call on renowned designers - NG Design, Dirk Wynants, Pieter Willemyns, Peter Leleu, Hanne Besard, Lennart Delporte, Karim Rashid and Tore Bleuzé - each of them has a creative vision and innovative ideas which give a whole new meaning to the concept of a standard umbrella.

Karim Rashid

Visionary and prolific, Karim Rashid is one of the most unique faces within the design world today. With more than 4,000 designs in production, more than 400 awards to his name and working in 47 countries, Karim's ability to transcend typology continues to make him a force among designers of his generation. Karim Rashid's Eclisum UX is the result of the collaboration between Umbrosa and Karim Rashid.

MADE IN BELGIUM

All design, development and assembly is done in Belgium, which provides all parties with the best guarantee for quality and flexibility.

SPARE PARTS

Even long after the warranty period, we want to grant you a lifelong enjoyment of our products. Therefore we offer an extensive after sales service program. Not only can you order replacement canopies or frames, but you can also order each available individual component of your umbrella. To make it easy for you, we have detailed technical drawings of each product, so that you can quickly identify the piece you need. Umbrosa will charge you a limited fixed cost for picking and packing of spare parts. Detailed drawings can be found on our website under the section 'downloads', or in the installation manuals.



NG Design, Hanne Besard, Karim Rashid, Lennart Delporte, Tore Bleuzé, Pieter Willemyns, Peter Leleu, Dirk Wynants



UMBROSA SHADE SAILS

Umbrosa also offers a range of shade sails. We have three different shapes that come in multiple sizes. The shade sails can be attached to a fixed or flexible point on a wall or on a pole with sliding unit. The pole is available in aluminium or black.

The price for Ingenua sails starts from

537 €

PRODUCTION LEAD TIMES

QUICK SHIP = 3 DAYS PRODUCTION TIME

NON QUICK SHIP = 3 WEEKS PRODUCTION TIME

- In order to give you a clear and transparent lead time, Umbrosa works with a simple indication of the departure date for each product and/or model. You will find a summary table with every collection. In that way you always know when goods will be available!
- The popular models are available as 'QS' or 'Quick Ship'. This means that the items will leave the Umbrosa warehouses within a maximum of 3 working days. From this year on, it is the fabric and not the pole finish that determines the production lead time. Within the standard range, Umbrosa offers the frame in Alu (anodised or lacquered in 'natural anodising') and/or lacquered in Black (RAL 9005) / Beige Limestone (RAL 1013), depending on the collection.
- All UX/PX collections have a production lead time of 3 weeks.**
- The non-Quick Ships are available within a maximum departure time of 3 weeks, meaning that these items will leave the Umbrosa warehouses within a period up to 3 weeks.
- The Quick Ship colours are available in usual quantities. Please get in touch with Umbrosa for more information.

PRODUCTION TIME, COLOURS AND MODELS												
SPECTRA	SOLIDUM				COLORUM							
	Natural	Canvas	Grey	Taupe	Marble	Mint	Blush	Pepper	Almond	Sand	Flanelle	Black
	QS	3	3	3	3	3	3	3	3	3	3	3

USE OF PRODUCTCODES

Use our simplified product codes to place your order. We have simplified the Umbrosa codes and as a result they are now much more user-friendly. Please mention the correct code with every order. This not only saves us time, but helps you as a client as well and will limit the chance of mistakes. SKU for mounting option are base must also be given.

Construction of the codes:

- name of the collection either in full or abbreviated
- the nature of the product or the form f.e. holder, pole, cover, round, square,...
- dimension/size of the umbrella
- the colour of the umbrella needs to be filled out at the back (in the Quick Ship chart, the colours are mentioned above the codes)



QR-CODES

On each collection page you will find a QR code with a direct link to the product's technical data sheet. In this way you can easily find the extra information needed to close your sale.

COMPLAINTS AND AFTER SALES SERVICE

Every complaint or after sales service will be treated with the utmost care once we have received the following information:

- Commercial Invoice
- Photos or video showing the problem
- Description of the issue

FABRICS

Umbrosa has two collections of parasol fabrics. The Solidum colours are standard colours. Per collection one or more colours are offered in Quick Ship. The fabric is 100% Acryl and is made by Dickson.

The Colorum collection contains the more exclusive colours and has a production lead time of 3 weeks. These fabrics, also 100% Acrylic, are manufactured by Dickson (Sunbrella) or Tuvatextil (Agora).

SOLIDUM: Acryl 250 gr/m² / Color Rating 7/8 (max = 8) / Water repellent

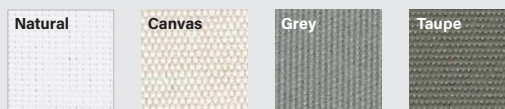

COLORUM: Acryl 260 gr/m² / Color Rating 7/8 (max = 8) / Water repellent

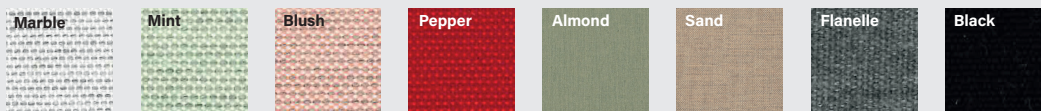

INGENUA

CONCEPT



QR code to spec sheet

Umbrosa doesn't shy away from any challenge when it comes to providing custom shade solutions, even for larger surfaces. With Ingenua's ingenious sliding system, adjusting the sail to the position of the sun, the conditions, and the surroundings is a breeze. The sleek lines and modern forms of Ingenua are combined with impressive wind resistance.

DESIGNER

Pieter Willemyns and the Umbrosa Design Team

USP

The most practical, flexible and stylish shade sail system

SELLING TIPS

- Accessible system with many possibilities, also for larger areas
- Numerous combinations and colours can create different atmospheres
- Unique sliding system in pole: adjustable in height and according to the position of the sun
- Quick assembly and disassembly of the sail

NICE TO KNOW

Most installations are done with at least one corner fixed to the wall, using the wall profile or wallkit. Sails can be fixed to any element that is strong enough (e.g. a tree). Every sail comes with a storage bag and the necessary ropes. The choice of size and shape is a matter of personal taste and depends on the area that needs to be covered. The Ingenua shade sails are to be used under normal weather circumstances and have a wind rating up to 50 km/h or 31 mp/h. When there are strong winds it is advisable to take the sails down.

The sails are water-repellent and not waterproof. Follow these 3 guidelines for a successful installation:

1. The fixation of a corner needs to be in the direction of the line that cuts a corner in two equal parts, ensuring maximum tension.
2. It is recommended to install the fixations on at least 0,5 m on each side of the sail. Example: a 4 m sail has fixation points that are 5 m from each other. Exception: one corner can be fixed directly on the wall without any ropes.
3. Make sure that you can put the sail under a 30° angle to ensure a good flow in case of rain and to prevent water pockets.

VERSIONS



ALU



BLACK



Triangle sail

4 x 4 x 4 m
5 x 5 x 5 m
4 x 5 x 6,4 m

From € 537



Square sail

4 x 4 m

From € 744



Rectangle sail

4 x 3 m
5 x 3 m
5 x 4 m

From € 810

QUICK SHIP

PRODUCTION TIME, COLOURS AND MODELS

INGENUA COLOUR	SOLIDUM				COLORUM								
	Natural	Canvas	Grey	Taupe	Marble	Curacao	Mint	Blush	Pepper	Almond	Sand	Flanelle	Black
TRIANGLE 4X4X4 M	3	QS	3	3	3	3	3	3	3	3	3	3	3
TRIANGLE 5X5X5 M	3	QS	QS	3	3	3	3	3	3	3	3	3	3
TRIANGLE 4X5X6,4 M	QS	QS	3	3	3	3	3	3	3	3	3	3	3
SQUARE 4X4 M	3	QS	QS	3	3	3	3	3	3	3	3	3	3
RECTANGLE 4X3 M	3	QS	QS	3	3	3	3	3	3	3	3	3	3
RECTANGLE 5X3 M	3	QS	QS	3	3	3	3	3	3	3	3	3	3
RECTANGLE 5X4 M	3	3	3	3	3	3	3	3	3	3	3	3	3

QS = 3 days / 3 = 3 weeks production time

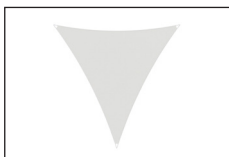

TRIANGLE SAIL

		Dimension	Fabric	Price VAT excl.
INTRIANG4x4x4-COLOUR		4 x 4 x 4 m	Solidum	€ 537
INTRIANG4x4x4-COLOUR			Colorum	€ 718
INTRIANG5x5x5-COLOUR		5 x 5 x 5 m	Solidum	€ 643
INTRIANG5x5x5-COLOUR			Colorum	€ 906
INTRIANG6x5x4-COLOUR		4 x 5 x 6,4 m	Solidum	€ 696
INTRIANG6x5x4-COLOUR			Colorum	€ 977

The sails are drawn with the seams down. They can be installed with the seams up or down. All sails come with ropes, dog bones and storage bag.



SQUARE SAIL

		Dimension	Fabric	Price VAT excl.
INSQUARE4x4-COLOUR		4 x 4 m	Solidum	€ 810
INSQUARE4x4-COLOUR			Colorum	€ 1146

All sails come with ropes, dog bones and storage bag.



RECTANGLE SAIL

		Dimension	Fabric	Price VAT excl.
INRECTANG4x3-COLOUR		4 x 3 m	Solidum	€ 744
INRECTANG4x3-COLOUR			Colorum	€ 1010
INRECTANG5x3-COLOUR		5 x 3 m	Solidum	€ 810
INRECTANG5x3-COLOUR			Colorum	€ 1146
INRECTANG5x4-COLOUR		5 x 4 m	Solidum	€ 978
INRECTANG5x4-COLOUR			Colorum	€ 1386

All sails come with ropes, dog bones and storage bag.

TRIANGLE
 • 4x4x4m/13' 1"x13' 1"x13' 1"
 • 5x5x5m/16' 5"x16' 5"x16' 5"









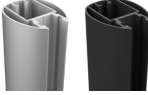

RIGHT-ANGLED TRIANGLE
 • 4x5x6.4m/13' 1"x16' 5"x21'

SQUARE
 • 4x4m/13' 1"x13' 1"

RECTANGLE
 • 4x3m/9' 10"x13' 1"
 • 5x3m/9' 10"x16' 5"
 • 5x4m/13' 1"x16' 5"

<small>+/- 2%</small>	A	B	C	D	E	F	G min	G max	H	H+I
<small>cm/ft</small>	<small>cm/ft</small>	<small>cm/ft</small>	<small>cm/ft</small>	<small>cm/ft</small>	<small>cm/ft</small>	<small>cm/ft</small>	<small>cm/ft</small>	<small>cm/ft</small>	<small>cm/inch</small>	<small>cm/ft</small>
INGENUA	260/8' 7" 300/9' 10"	46/1' 6" 53/1' 9"	80°	260/8' 7"	90°	165/5' 5"	50/1' 8"	150/4' 11"	20/8"	<500/<16' 5"

MOUNTING OPTIONS

		Description	Dimension	Finish	Price VAT excl.
Poles					
INPOLE-ALUN-260		Ingenua pole 80/90° for installation of maximum 2 Ingenua sails. Each pole comes with a sliding unit. ATTENTION: for 2 sails on 1 pole, always install 90°.	2,6 m	ALU	€ 345
INPOLE-BLACKN-260				BLACK (RAL 9005)	€ 405
INPOLE-ALUN-300			3 m	ALU	€ 430
Hard ground					
UM-ROUNDSUPPORT-90		To install the pole on a hard ground (concrete - wood).	90°		€ 130
UM-ROUNDSUPPORT-80			80°		
Soft ground					
INGROUNDANCHORAGE-90		Concrete anchorage to install the pole in a 'soft' ground pouring concrete. To use in a combination with a round support.	90°		€ 144
INGROUNDANCHORAGE-80			80°		
Wall mount					
UM-WALLBRACKETS		Wall brackets - set of 2 - stainless steel - to install the Ingenua pole on the wall.			€ 61
INWALLKIT		Wallkit for installation on the wall - includes eye screw (with expansion bolt), wall unit, pulley and a rope of 5 m - attention: bolts included are not appropriate for all types of halls.			€ 119
INWALLPROFILEALU		Wall profile - wall mount with slider - wall profile for the fixation of the sail to the wall with sliding mechanism - includes wall profile of 1,6 m - attention: bolts included are not appropriate for all grounds.		ALU	€ 192
INWALLPROFILEBLACK				BLACK (RAL 9005)	
INHEAVYDUTYTUBE		Heavy duty insert pole - to fortify Ingenua poles (2,6/3 m) which are heavily burdened - to use with round support or concrete anchorage.			€ 154
INSLIDINGUNIT		Ingenua extra slider unit to attach a second sail on the pole - 1 piece standardly included with the Ingenua pole.			€ 80
UM-BASEPLATEN		Baseplate: easy installation for all supports (80°-90°) - has to be mounted together with the round support - allows easy removal of the round support during winter.			€ 95
INROPESET-2M-PART		Spare part - rope set 2 m - 2 pc. Accessories included.			€ 71
INROPESET-6M-PART		Spare part - rope set 6 m - 2 pc. Accessories included.			€ 71

WARRANTY

USE

Umbrosa always adheres to the warranty obligations of Belgian and European manufacturers in accordance with the law. All warranty requests must be submitted out via the trader or website where the product was purchased. Umbrosa strives to develop and produce **high-end, high-quality, and sustainable products**. Products that are optimized to withstand weather conditions and the environment in which they are used. All Umbrosa products are **extensively tested to guarantee their quality**. This includes tests conducted at the University of Delft (NL) wind tunnel, and component testing with independent research laboratories. In case of damage, the Umbrosa products can be repaired. A **comprehensive after-sales department** has been put in place to this end. The biggest threat to the lifespan of an Umbrosa umbrella are the weather conditions and external environmental factors. Therefore, always provide the appropriate care for any Umbrosa product and never leave it open unattended. Damage caused by incorrect use or extreme weather conditions such as wind, snow, hail, storm, ... is excluded from the warranty. **Wind tunnel tests** with permanent fixation of the umbrella have shown that Umbrosa products can withstand wind speeds of over **40 km/hour (5 Beaufort)**. Damage caused at unattended moments or by poor fixation or use of weak supports are not covered by our warranty programme. As wind does not have a constant speed, and as gusts of wind are often more powerful than imagined, we advise to close the umbrella at all times whenever wind speeds exceed 30 km/hour (4 Beaufort). When closing the umbrella the strap and protection cover need to be correctly used. Failure in doing so can cause damage even in a closed position. This kind of damage is not covered by our warranty programme. The use of mobile or movable base has an impact on the wind resistance of the umbrella. Therefore, always select the heaviest available base to enhance security. Always contact the distributor or Umbrosa should you desire advice on the anchoring method to be used. www.umbrosa.com contains a large amount of information on this topic. Direct and indirect damage caused by a falling umbrella, whether it is in open or closed position, is not covered by the warranty. Tests conducted by independent laboratories have demonstrated that the corrosion resistance of Umbrosa products is better than normal. With intensive usage of the products in a hostile (sea, sand, chlorine, ...) environment, we advise that you regularly rinse the frame and canopy of the umbrella using fresh water in order to prevent the build-up of salt residue. You can purchase these from Umbrosa. Use of the warranty always requires the presentation of the original purchase invoice. Umbrosa also makes use of serial numbers. This number must always be stated with every warranty request. www.umbrosa.com offers a complaint form with clear specifications of the information necessary to process the warranty request efficiently and quickly. Warranty requests must always be submitted in writing within a reasonable term after the initial observation of the issue. Umbrosa guarantees that the problem will be solved, **be it through replacement, repair, or a custom solution**. The warranty is always extended with the duration of "non-usage". The warranty does not restart in case of replacement with a new product. Transportation and performance of the repairs are not borne by Umbrosa. The Umbrosa guarantee only applies if the product was installed in accordance with the Umbrosa installation manual. The warranty shall completely lapse in case of use of accessories not approved by Umbrosa.

SPECIAL WARRANTY PROVISIONS "HARDWARE" :

15-year warranty**

Umbrosa offers a 15-year warranty on all aluminum extrusion profiles. This warranty only covers damage caused by construction or manufacturing errors, scratches, superficial corrosion, and wear due to use are not covered by this warranty unless the product is structurally weakened as a result.

5-year warranty*

Umbrosa offers a 5-year warranty on all glass fiber ribs and all welded tubes. Umbrosa offers a 5-year warranty on all stainless steel. Scratches, superficial corrosion, and wear due to use are not covered by this warranty unless the product is structurally weakened as a result.

3-year warranty*

Umbrosa offers a 3-year warranty on all synthetic parts and all galvanized steel parts. Scratches and wear due to use are not covered by this warranty unless the product is structurally weakened as a result.

2-year warranty*

Umbrosa offers a 2-year warranty on granite base, tile base, and mobile concrete base. Scratches, superficial corrosion, and wear due to use are not covered by this warranty. Breakage of the concrete or granite base due to use in case of strong wind is not covered under this warranty. In case of breakage, the new replacement concrete part may show a difference in colour, this is unavoidable. Umbrosa offers a 2-year warranty on all painted parts. Whenever the paint flakes off or forms bubbles, Umbrosa will replace the damaged item, or present a custom solution.

Caution:

Umbrosa uses natural products or materials (wood, concrete, granite, ...) that are susceptible to weather conditions and thus naturally age. The natural ageing process in outdoor conditions is not covered by warranty. Likewise, Umbrosa cannot guarantee that its products will be free from stains due to animal excrement and/or pollution phenomena.

(*) Warranty is only applicable when the Umbrosa products are used under normal wind conditions and when they are thoroughly and regularly maintained as described in the manual under chapter 'do's and don't's'. Direct or indirect damage caused by incorrect use or wrong installation are not covered by the warranty.

WARRANTY

SPECIAL WARRANTY PROVISIONS "FABRICS & TEXTILE PREFABRICATION" :

Extensive research, testing and years of experience have proven fabrics in acrylic to be the best fabric for use on the Umbrosa products.

5 year warranty (except for Ingenua and protection covers) **

All fabrics in all collections, with the explicit exception of the Ingenua collection, a 5-year warranty is offered for discolouration and structural integrity. In the exceptional case of discolouration, Umbrosa will lay out a compensation proposal proportional to the usage period of the product, or a choice will be offered to receive a new canopy whereby the cost for cutting & prefabrication will be charged. Under no circumstances will discolouration result in the free delivery of a new canopy. Burn holes, melted holes, or fabric deformation are therefore not covered by the warranty since these are caused by inappropriate use of the umbrosa products. Daily protection of the umbrella using the protection cover enhances the lifespan of the umbrella exponentially.

2 or 3 year warranty for the Ingenua sails ()**

For no other product is usage intensity as well as exposure to UV so different from user to user. Due to the intensive usage of Ingenua sails, very specific warranty conditions apply to this collection.

The warranty on these sails covers discolouration and structural integrity. For continental Europe, this warranty is 3 years. In the exceptional case of discolouration, Umbrosa will lay out a compensation proposal proportional to the usage period of the product, or a choice will be offered to receive a new canopy whereby the cost for cutting & prefabrication will be charged. Under no circumstances will discolouration result in the free delivery of a new canopy. Outside of continental Europe, the warranty is 2 years. Research does show that the expected lifespan is 5 to 8 years under normal usage, i.e. with daily covering of the sail using the appropriate protection cover and storing it in a dry place.

Special warranty conditions - Zippers

Zippers are very susceptible to correct usage. The risk of breakage increases exponentially in case of inappropriate usage of the zipper. Therefore, study the usage instructions very closely if the selected product has a zipper. If the zipper is stiff, this issue can quickly be resolved using a silicone spray or another lubricant (no oil!).

In case of zipper breakage, Umbrosa can send a replacement zipper.

LEGAL WARRANTY ON PROTECTION COVERS :

Protection covers are covered by the legal warranty.

PRICES AND DIMENSIONS

- Prices are subject to change. The prices are the basis for the discount that applies to you. So please always contact us to be sure you have the most recent pricelist. Do not hesitate to contact us if you would like to receive a specific quotation for larger quantities or for a specific project.
- The dimensions listed in this pricelist may vary with +/-2%, we are not responsible for any discrepancies within this margin. If a dimension is of extreme importance, please do not hesitate to contact Umbrosa to ask for the latest drawing.
- Items not mentioned in this price list are only available under certain conditions. For more details, contact Umbrosa.

NICE TO KNOW

UV rays have an impact on all substances and materials that are used outside. On the one hand we can speak about the 'discolouration' of the fabrics and on the other hand also about 'weakening'. Both can affect life expectancy. In addition, UV rays also have a detrimental effect on people. The UV rays can cause skin irritation, skin aging and skin cancer. To prevent these effects of UV rays, Umbrosa is using high quality fabrics and materials which have a proven colour fastness and offer the necessary protection against the sun. Umbrosa guarantees you products that will bring you years of joy.

(**) Warranty is only valid if the user does not make any changes to the specified sail systems and accessories. Umbrosa products are used under normal wind conditions and are well and regularly maintained. Damage caused by friction or water collection are not covered by the warranty. This must be avoided at all times as described in the manual chapter 'Do's and Don't's'.

WARRANTY

BEAUFORT SCALE

BEAUFORT N°	DESCRIPTION	KM/U	MPH	EFFECTS OBSERVED ON LAND
1	Light air	1-5	1-3	Direction of wind shown by smoke drift.
2	Light breeze	6-11	4-6	Wind felt on face, leaves rustle.
3	Gentle breeze	12-19	7-10	Leaves and small twigs in constant motion, wind extends light flag.
4	Moderate breeze	20-28	11-16	Raises dust and loose paper, small branches are moved.
5	Fresh breeze	29-38	17-21	Small trees in leaf begin to sway, crested wavelets form on inland waters.
6	Strong breeze	39-49	22-27	Large branches in motion, umbrellas used with difficulty.
7	Near gale	50-61	28-33	Whole trees in motion, inconvenience felt in walking against the wind.
8	Gale	62-74	34-40	Breaks twigs of trees.
9	Strong gale	75-88	41-47	Slight structural damage occurs (chimney pots and slate removed).
10	Storm	89-102	48-55	Trees uprooted, considerable structural damage occurs.

PRODUCT STRENGTH ACCORDING TO THE BEAUFORT SCALE*

PRODUCT	BFT SCORE	PRODUCT	BFT SCORE
PARAFLEX / PARAFLEX UX/PX	3 - 6	INGENUA	4 - 8
SPECTRA / VERSA UX/PX	4 - 7	ECLIPSUM UX/PX	5 - 6
NATA / NATA UX	5 - 6	ICARUS / ICARUS UX/PX	5 - 9

* The wind scores are valid for a parasol placed on the ground floor. For installation of a parasol on another, higher floor, contact Umbrosa for the best possible solution.

TIPS FOR THE IDEAL WIND POSITION

NATA / NATA UX

For Nata, we advise to avoid wind from below (1), to fully open the canopy and put the umbrella on a flat surface. When closing the umbrella the strap needs to be correctly used. Failure in doing so can cause damage even in a closed position.

PARAFLEX / PARAFLEX UX / PARAFLEX PX

For Paraflex (UX/PX) we advise to position the arm following the direction of the wind (1), completely stretch out the arm (2), place the grip in between the ribs (3), put the umbrella horizontally (4) and on a flat surface.

SPECTRA / VERSA UX / VERSA PX

For Spectra, Versa (UX/PX), we advise to position the umbrella in the direction of the wind (1), put the arm in a 10° angle (2) and put the umbrella on a flat surface.

ICARUS / ICARUS UX / ICARUS PX

For Icarus (UX/PX), we advise to position the umbrella in the direction of the wind (1), put the umbrella in a slight upward position (2) and put it on a flat surface.

ECLIPSUM UX / ECLIPSUM PX

For Eclisum (UX/PX), we advise to position the umbrella in the direction of the wind (1), put the circle under a slight angle (2) and put it on a flat surface.

INGENUA

For Ingenua, we advise you to put the sail in a angled position to prevent wind from getting under the sail (1); to put full tension on the sail only by using the Umbrosa ropes and dogbones (2) and to install the poles in a backward position (3).

GENERAL

When closing the umbrella, the strap and protection cover need to be correctly used. Failure in doing so can cause damage, even in a closed position.

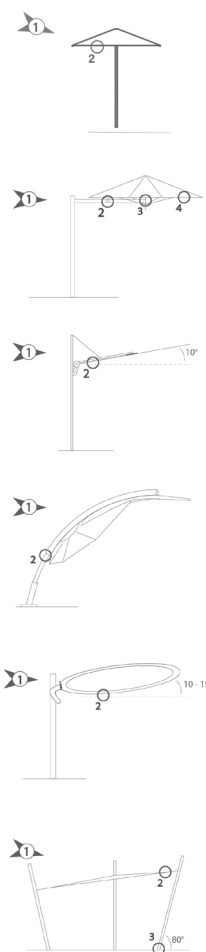

CENNÍK 2025

Parasol collection

CENY BEZ DPH

Valid from October 1, 2024

Presented by

UMBROSA

ELMINA[®]
můj životní styl

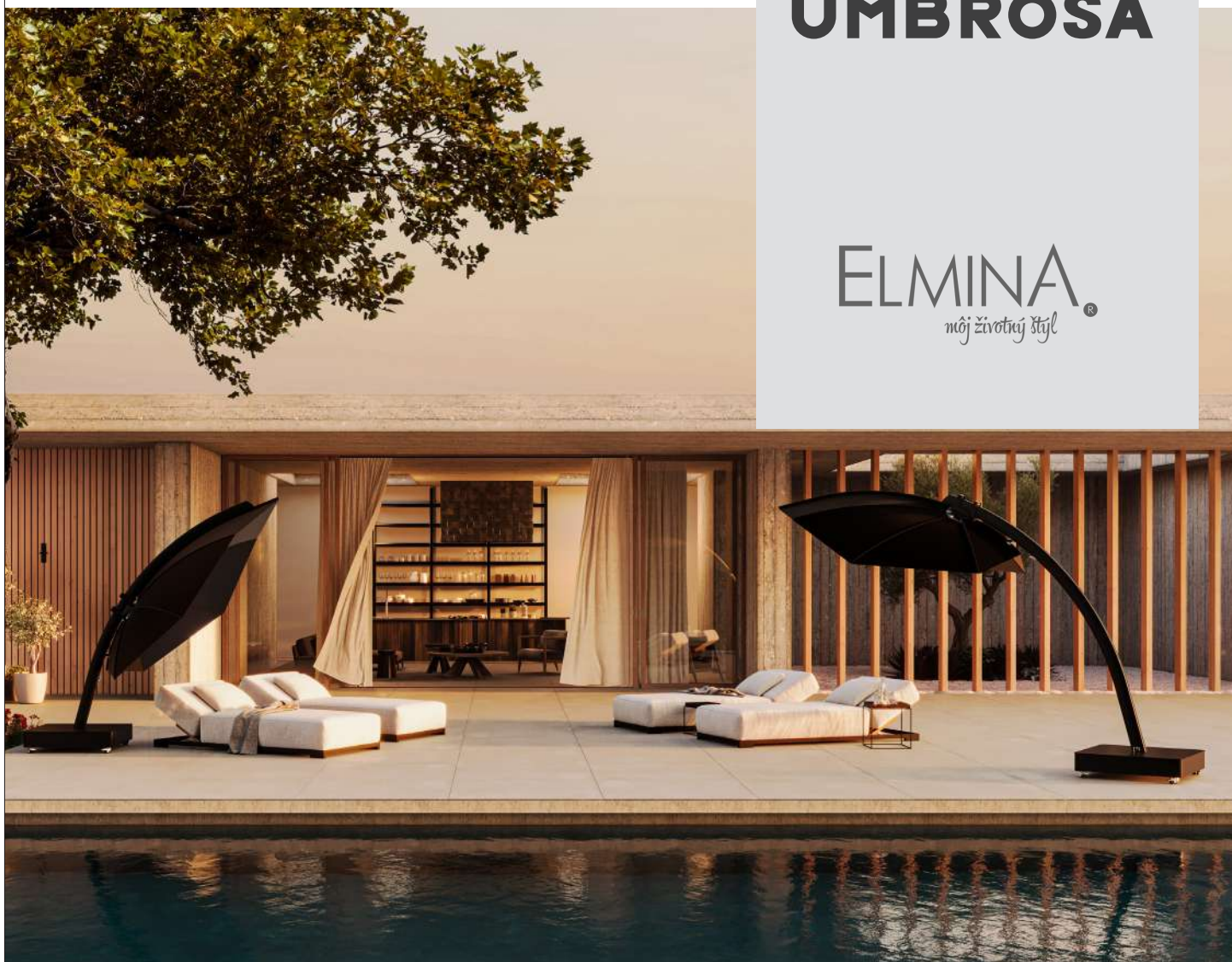



UMBROSA COMPANY

umbrosus, a, um (adi.) 1. Shady, leafy, full of shade, shaded - Umbrosa embodies innovative shade solutions with a young and dynamic appeal. Our umbrella collections exude class, flexibility, and thoughtful design. They ensure protection from the sun in an effortless and stylish manner. At Umbrosa, we make a statement of elegance and simplicity. We collaborate with leading international designers and proudly produce under the label 'Made In Belgium'. Our team of designers and creative minds pays special attention to the unique character and bold creativity of each design.

Quality and sustainability are essential values in our production process, resulting in long-lasting shade year after year. Our umbrella families have become renowned worldwide on the most breathtaking terraces and among the most prestigious hotel groups in over 90 countries. Nature is an endless source of inspiration that constantly stimulates us. Just as trees and plants provide shade in a unique way, we aim to offer shade solutions to our customers in that same distinctive manner.

Umbrosa strives to develop versatile and innovative shade creations that are far removed from the traditional umbrella. As the unique umbrella design brand for both residential and commercial use, Umbrosa offers affordable prices without compromising on style and quality.

TEAM

At Umbrosa, customers experience the perfect combination of flexibility and personal service, typical of a small-scale organization, while enjoying the expertise and reputation of a global player, as evidenced by our numerous international references. Our loyal customers benefit from the advice and guidance of a dedicated contact person, who's full of passion and knowledge and ready to assist them. With our team of 40 people based in Belgium, we master the entire production process, from innovative product development to successful commercialization. We take pride in the fact that all our products, ranging from Paraflex and Ingenua to Icarus, Spectra, Infina, and the UX collection, are manufactured with care and craftsmanship in Belgium: a guarantee of sustainable Belgian quality! April 2022 marks an exciting milestone for Umbrosa! Not only have we expanded our sales activities to the United States, but we are also delivering directly from our brand-new warehouse in Baytown, TX. We can't wait to conquer the American market, which is filled with unprecedented potential for Umbrosa. Get ready, USA, Umbrosa is coming!

VISION AND MISSION STATEMENT

Vision

Umbrosa wants to provide all terraces and gardens around the world with Unique Shade Solutions.

Mission

To manufacture high-end shade solutions in Belgium, that offer the optimal user experience, by designing unique, innovative and sustainable products, that have an impact on outdoor living.

Values

Passion | Communication | Perfection | Personal growth



TABLE OF CONTENTS

Umbrosa presentation		p. 02
Practical arrangements		p. 05
Nata NEW		p. 07
Paraflex NEW SIZES ALSO AVAILABLE AS PX		p. 12
Spectra NEW FRAME COLOUR		p. 21
Icarus ALSO AVAILABLE AS PX		p. 29
Versa BESTSELLER		p. 36
Eclisum ALSO AVAILABLE AS PX		p. 43

DESIGNERS

Umbrosa distinguishes itself by a daring design that is both accessible and playful. To obtain this, we call on renowned designers - NG Design, Dirk Wynants, Pieter Willemyns, Peter Leleu, Hanne Besard, Lennart Delporte, Karim Rashid and Tore Bleuzé - each of them has a creative vision and innovative ideas which give a whole new meaning to the concept of a standard umbrella.

Karim Rashid

Visionary and prolific, Karim Rashid is one of the most unique faces within the design world today. With more than 4,000 designs in production, more than 400 awards to his name and working in 47 countries, Karim's ability to transcend typology continues to make him a force among designers of his generation. Karim Rashid's Eclisum UX is the result of the collaboration between Umbrosa and Karim Rashid.

MADE IN BELGIUM

All design, development and assembly is done in Belgium, which provides all parties with the best guarantee for quality and flexibility.

SPARE PARTS

Even long after the warranty period, we want to grant you a lifelong enjoyment of our products. Therefore we offer an extensive after sales service program. Not only can you order replacement canopies or frames, but you can also order each available individual component of your umbrella. To make it easy for you, we have detailed technical drawings of each product, so that you can quickly identify the piece you need. Umbrosa will charge you a limited fixed cost for picking and packing of spare parts. Detailed drawings can be found on our website under the section 'downloads', or in the installation manuals.



NG Design, Hanne Besard, Karim Rashid, Lennart Delporte, Tore Bleuzé, Pieter Willemyns, Peter Leleu, Dirk Wynants



PRODUCTION LEAD TIMES

QUICK SHIP = 3 DAYS PRODUCTION TIME

NON QUICK SHIP = 3 WEEKS PRODUCTION TIME

- In order to give you a clear and transparent lead time, Umbrosa works with a simple indication of the departure date for each product and/or model. You will find a summary table with every collection. In that way you always know when goods will be available!
- The popular models are available as 'QS' or 'Quick Ship'. This means that the items will leave the Umbrosa warehouses within a maximum of 3 working days. From this year on, it is the fabric and not the pole finish that determines the production lead time. Within the standard range, Umbrosa offers the frame in Alu (anodised or lacquered in 'natural anodising') and/or lacquered in Black (RAL 9005) or in Beige Limestone (RAL 1013), depending on the collection.
- All UX/PX collections have a production lead time of 3 weeks.**
- The non-Quick Ships are available within a maximum departure time of 3 weeks, meaning that these items will leave the Umbrosa warehouses within a period up to 3 weeks.
- The Quick Ship colours are available from 1-5 pieces. Please get in touch with Umbrosa for more information.

PRODUCTION TIME, COLOURS AND MODELS												
SPECTRA	SOLIDUM				COLORUM							
	Natural	Canvas	Grey	Taupe	Marble	Mint	Blush	Pepper	Almond	Sand	Flanelle	Black
	QS	3	3	3	3	3	3	3	3	3	3	3

USE OF PRODUCTCODES

Use our simplified product codes to place your order. We have simplified the Umbrosa codes and as a result they are now much more user-friendly. Please mention the correct code with every order. This not only saves us time, but helps you as a client as well and will limit the chance of mistakes. SKU for mounting option are base must also be given.

Construction of the codes:

- name of the collection either in full or abbreviated
- the nature of the product or the form f.e. holder, pole, cover, round, square,...
- dimension/size of the umbrella
- the colour of the umbrella needs to be filled out at the back (in the Quick Ship chart, the colours are mentioned above the codes)



QR-CODES

On each collection page you will find a QR code with a direct link to the product's technical data sheet. In this way you can easily find the extra information needed to close your sale.

COMPLAINTS AND AFTER SALES SERVICE

Every complaint or after sales service will be treated with the utmost care once we have received the following information:

- Commercial Invoice
- Photos or video showing the problem
- Description of the issue

FABRICS

Umbrosa has two collections of parasol fabrics. The Solidum colours are standard colours. Per collection one or more colours are offered in Quick Ship. The fabric is 100% Acryl and is made by Dickson.

The Colorum collection contains the more exclusive colours and has a production lead time of 3 weeks. These fabrics, also 100% Acrylic, are manufactured by Dickson (Sunbrella) or Tuvatextil (Agora).

SOLIDUM: Acryl 250 gr/m² / Colour Rating 7/8 (max = 8) / Water repellent

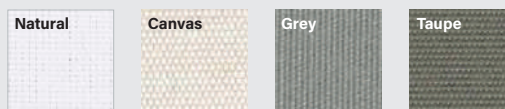

COLORUM: Acryl 260 gr/m² / colour Rating 7/8 (max = 8) / Water repellent

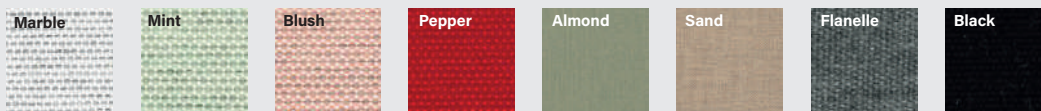

UMBROSA COLLECTIONS

OVERVIEW UMBROSA PARASOL COLLECTIONS			
	STANDARD	UX	PX
NATA	•	•	
PARAFLEX	•	•	•
SPECTRA	•		
VERSA		•	•
ICARUS	•	•	•
ECLIPSUM		•	•

STANDARD COLLECTION

Each model of the standard collection is available with 12 different fabric colours. In this collection, we offer Quick Ship models that can leave our warehouse within three working days. The rest of the models have a production time of 3 weeks.



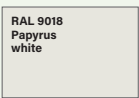
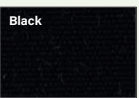
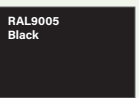
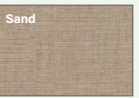
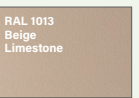
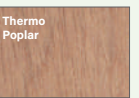

UX-COLLECTION

Each UX parasol (Unique experience) is a unique combination of colour, shape and materials. **Depending on the collection**, we have up to 8 fixed UX combinations: Full Black, Architecture, Sand, Latte, Safari, Nostalgic Plu, Nostalgic Roman and Nostalgic Zen. These products have a production lead time of 3 weeks.

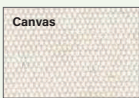
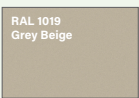
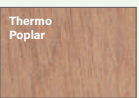
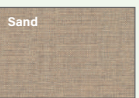
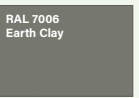
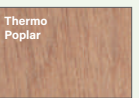
UX combinations

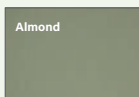
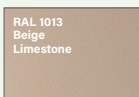
Architecture		Full Black		Sand		
Canopy	Frame + base	Canopy	Frame + base	Canopy	Frame + base	Cover base
						

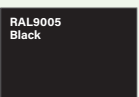
Latte			Safari		
Canopy	Frame + base	Cover base	Canopy	Frame + base	Cover base
					

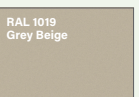
Plu		Roman		Zen	
Canopy	Frame	Canopy	Frame	Canopy	Frame
					

PX COLLECTION

A PX parasol is a personalized version of a UX model, put together according to your personal taste or that of your customer. PX stands for "Personal Experience" and means that you can freely combine the colour of the frame, canopy and parasol base within the colours offered. These products have a production lead time of 3 weeks.

NATA

NEW

CONCEPT



The Nata center post umbrella is a sophisticated and user-friendly addition to any outdoor environment. With its simple design, this parasol offers a timeless aesthetic that perfectly suits both small and large projects.

DESIGNER

Umbrosa Design Team

USP

Simplicity meets elegance.

SELLING TIPS

- Elegant and compact center post umbrella
- Center post umbrella with tilt function for standard version, the UX version has no tilt function
- Very easy to open and close
- Protection cover is optional

NATA STANDARD

BLACK

RAL 9005

BEIGE
LIMESTONE

RAL 1013



NATA ROUND

Ø 2,8 m

Ø 3,2 m

From € 701



NATA SQUARE

2 x 2 m

2,3 x 2,3 m

From € 610

NATA UX

BEIGE
LIMESTONE

RAL 1013

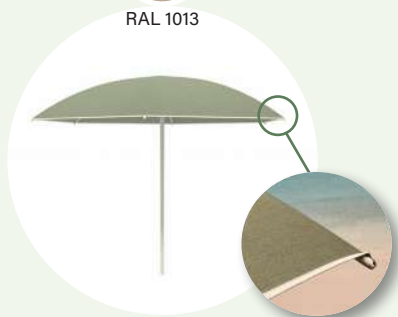

NOSTALGIC PLU

Ø 2,8 m

From € 990

GREY
BEIGE

RAL 1019



NOSTALGIC ZEN

Ø 2,8 m

From € 860

BLACK

RAL 9005

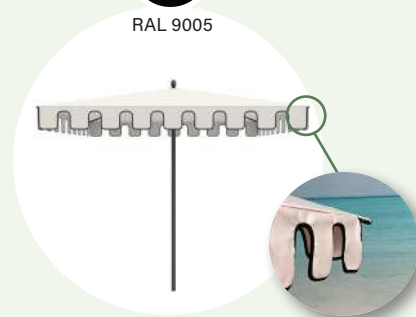

NOSTALGIC ROMAN

2,3 x 2,3 m

From € 860



NATA STANDARD

QUICK SHIP

PRODUCTION TIME, COLOURS AND MODELS												
NATA COLOUR	SOLIDUM				COLORUM							
	Natural	Canvas	Grey	Taupe	Marble	Mint	Blush	Pepper	Almond	Sand	Flanelle	Black
ROUND 2,8 M	3	QS	3	3	3	3	3	3	3	3	3	3
ROUND 3,2 M	3	QS	3	3	3	3	3	3	3	3	3	3
SQUARE 2 M	3	QS	3	3	3	3	3	3	3	3	3	3
SQUARE 2,3 M	3	QS	3	3	3	3	3	3	3	3	3	3

QS = 3 days / 3 = 3 weeks production time



NATA ROUND

NATA ROUND		PRICE frame + canopy			
 Black Frame	Beige Limestone Frame	Dimension	Fabric	⁽¹⁾	Concrete base incl. ⁽²⁾
NATT280ROBLACK-COLOUR	NATT280ROLIME-COLOUR	Ø 2,8 m	Solidum	€ 701	€ 917
NATT280ROBLACK-COLOUR	NATT280ROLIME-COLOUR	Ø 2,8 m	Colorum	€ 771	€ 987
NATT320ROBLACK-COLOUR	NATT320ROLIME-COLOUR	Ø 3,2 m	Solidum	€ 869	€ 1.085
NATT320ROBLACK-COLOUR	NATT320ROLIME-COLOUR	Ø 3,2 m	Colorum	€ 956	€ 1.172



NATA SQUARE



NATA SQUARE		PRICE frame + canopy			
 Black Frame	Beige Limestone Frame	Dimension	Fabric	⁽¹⁾	Concrete base incl. ⁽²⁾
NATT200SQBLACK-COLOUR	NATT200SQLIME-COLOUR	2 m	Solidum	€ 610	€ 826
NATT200SQBLACK-COLOUR	NATT200SQLIME-COLOUR	2 m	Colorum	€ 671	€ 887
NATT230SQBLACK-COLOUR	NATT230SQLIME-COLOUR	2,3 m	Solidum	€ 732	€ 948
NATT230SQBLACK-COLOUR	NATT230SQLIME-COLOUR	2,3 m	Colorum	€ 805	€ 1.021

⁽¹⁾ Support not included

⁽²⁾ Use on parasol base

NATA STANDARD

MOUNTING OPTIONS AND BASES

		Description	Price VAT excl.
Round support		Support required for fixing on a hard surface.	€ 143
ROUNDSUPPORTTYPE2			
Soft ground		Concrete anchor to anchor pole through concrete in soft ground - to be used in conjunction with support.	€ 165
INGROUNDANCHORTYPE1			
Concrete bases		Round concrete base Natural, 40 kg.	€ 216
CONCRETEBASE40			
CONCRETEBASE40BLACK			

REPLACEMENT CANOPIES - PROTECTION COVER

	Shape	Dimension	Fabric	Price VAT excl.
NATA280COVERRO-COLOUR	ROUND	2,8 m	Solidum	€ 324
NATA280COVERRO-COLOUR			Colorum	€ 394
NATA320COVERRO-COLOUR		3,2 m	Solidum	€ 402
NATA320COVERRO-COLOUR			Colorum	€ 489
NATA200COVERSQ-COLOUR	SQUARE	2 m	Solidum	€ 299
NATA200COVERSQ-COLOUR			Colorum	€ 360
NATA230COVERSQ-COLOUR		2,3 m	Solidum	€ 371
NATA230COVERSQ-COLOUR			Colorum	€ 444
PFPROTECTION	Cover bag one size! Fits all Nata models - stick included - the cover needs to be folded for smaller models. Material: Polyester.			€ 98



NATA UX

Nata UX collection - production time: 3 weeks.

NATA UX	PRICE frame + canopy			
	Dimension	Fabric	⁽¹⁾	Concrete base incl. ⁽²⁾
PLU280ROLIME-ALMON	Ø 2,8 m	Almond	€ 990	€ 1.206
ZEN280ROGRBE-CANVA	Ø 2,8 m	Canvas	€ 860	€ 1.076
ROM230SQBLACK-CANVA	2,3 m x 2,3 m	Canvas	€ 860	€ 1.076

Nata UX combinations

Nostalgic Plu		Nostalgic Zen		Nostalgic Roman	
Canopy	Frame + base	Canopy	Frame + base	Canopy	Frame + base

REPLACEMENT CANOPIES - PROTECTION COVER

	Dimension	Fabric	Price VAT excl.
PLU280COVERRO-ALMON	Ø 2,8 m	Almond	€ 480
ZEN280COVERRO-CANVA	Ø 2,8 m	Canvas	€ 448
ROM230COVERSQ_CANVA	2,3 m x 2,3 m	Canvas	€ 535
NTPROTECTION_UX	Protection cover (Flanelle) for Nostalgic Zen and Roman.		€ 154
PLPROTECTION_UX	Protection cover (Flanelle) for Nostalgic Plu.		€ 238

NATA STANDARD

NATA UX

	NATA STANDARD			NATA UX		
	A	B	D	E = A	F	
	cm/ft	cm/ft	mm/inch	cm/ft	cm/ft	
2m80/9' 2.2"	232/7' 7.3"	205/6' 8.7"	Ø50x2 / Ø2"x0.1"	232/7' 7.3"	56/1' 10"	
3m20/10' 6"	232/7' 7.3"	200/6' 6.7"	Ø50x2 / Ø2"x0.1"	232/7' 7.3"	56/1' 10"	
2m/6' 6.7"	232/7' 7.3"	205/6' 8.7"	Ø50x2 / Ø2"x0.1"	232/7' 7.3"	56/1' 10"	
2m30/7' 6.6"	232/7' 7.3"	200/6' 6.7"	Ø50x2 / Ø2"x0.1"	232/7' 7.3"	56/1' 10"	
PLU 2m80/9' 2.2"	232/7' 7.3"	180/5' 10.9"	Ø50x2 / Ø2"x0.1"	232/7' 7.3"	56/1' 10"	

⁽¹⁾ Support not included

⁽²⁾ Use on parasol base

PARAFLEX

CONCEPT



Nothing beats the versatility of the human body. As a result, for the Paraflex, we let ourselves be inspired by the manoeuvrability and strength of the human arm. A space-saving solution, without a base and without a pole, which offers you the possibility to create shade wherever you want, by means of one, two or more umbrellas, according to your needs. The light and compact Paraflex offers maximum shade and is highly wind-resistant.

DESIGNER

Peter Leleu

USP

The world's most flexible parasol.

SELLING TIPS

- Ideal for patios where there is no room for a base or pole (Wallflex)
- Flexible arm provides shade where desired
- Several configurations possible
- Easy to assemble
- Very easy to handle and store

VERSIONS

PARAFLEX STANDARD

ALU



PARAFLEX WALL
From € 996



PARAFLEX MONO
From € 1.388



PARAFLEX DUO
From € 2.534



PARAFLEX MULTI
From € 4.525

Square: 2 x 2 m and 2,3 x 2,3 m
Round: 2,7 m and 3 m

PARAFLEX UX

BLACK



PARAFLEX UX WALL
From € 1.400

Square: 2 x 2 m and 2,3 x 2,3 m

PARAFLEX PX

BLACK



PARAFLEX PX
From € 1.497

Paraflex PX freely combinable:
2 sizes, 1 frame and arm colour, 8 fabric colours

NEW

FABRIC COLOURS

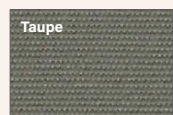
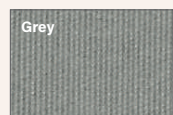
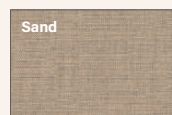
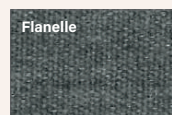
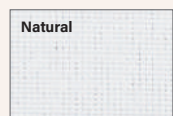
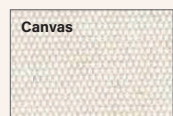
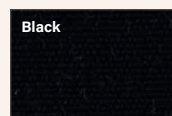



PARAFLEX STANDARD

QUICK SHIP

PRODUCTION TIME, COLOURS AND MODELS												
PARAFLEX COLOUR	SOLIDUM				COLORUM							
	Natural	Canvas	Grey	Taupe	Marble	Mint	Blush	Pepper	Almond	Sand	Flanelle	Black
ROUND 2,7 M	QS	QS	QS	QS	3	3	3	3	3	3	3	3
ROUND 3 M	3	QS	QS	QS	3	3	3	3	3	3	3	3
SQUARE 2 M	3	QS	QS	3	3	3	3	3	3	3	3	3
SQUARE 2,3 M	QS	QS	QS	QS	3	3	3	3	3	3	3	3

QS = 3 days / 3 = 3 weeks production time

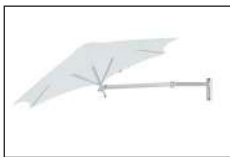

PARAFLEX WALL

PARAFLEX ROUND				PRICE frame + canopy + NEO arm + protection cover		
	Dimension	Fabric	Price VAT excl.			
PFWALL270NEO-COLOUR	2,7 m	Solidum	€ 1.135			
PFWALL270NEO-COLOUR	2,7 m	Colorum	€ 1.257			
PFWALL300NEO-COLOUR	3 m	Solidum	€ 1.277			
PFWALL300NEO-COLOUR	3 m	Colorum	€ 1.431			

PARAFLEX SQUARE				PRICE frame + canopy + NEO arm + protection cover		
	Dimension	Fabric	Price VAT excl.			
PFWALL200NEO-COLOUR	2 m	Solidum	€ 996			
PFWALL200NEO-COLOUR	2 m	Colorum	€ 1.110			
PFWALL230NEO-COLOUR	2,3 m	Solidum	€ 1.229			
PFWALL230NEO-COLOUR	2,3 m	Colorum	€ 1.389			



PARAFLEX MONO

PARAFLEX ROUND						PRICE frame + canopy + NEO arm + single pole & support + protection cover					
	Dimension	Fabric	Round support incl. ⁽¹⁾ ROUNDSUPPORTTYPE1	Concrete anchorage incl. ⁽²⁾ INGROUNDANCHORTYPE1	Mobile tile base incl. ⁽³⁾ TILEBASESTD-L-ALU						
PFMONO270NEO-COLOUR	2,7 m	Solidum	€ 1.528	€ 1.693	€ 2.325						
PFMONO270NEO-COLOUR	2,7 m	Colorum	€ 1.649	€ 1.815	€ 2.446						
PFMONO300NEO-COLOUR	3 m	Solidum	€ 1.670	€ 1.835	€ 2.466						
PFMONO300NEO-COLOUR	3 m	Colorum	€ 1.824	€ 1.989	€ 2.620						

PARAFLEX SQUARE						PRICE frame + canopy + NEO arm + single pole & support + protection cover					
	Dimension	Fabric	Round support incl. ⁽¹⁾ ROUNDSUPPORTTYPE1	Concrete anchorage incl. ⁽²⁾ INGROUNDANCHORTYPE1	Mobile tile base incl. ⁽³⁾ TILEBASESTD-L-ALU						
PFMONO200NEO-COLOUR	2 m	Solidum	€ 1.388	€ 1.553	€ 2.185						
PFMONO200NEO-COLOUR	2 m	Colorum	€ 1.502	€ 1.668	€ 2.299						
PFMONO230NEO-COLOUR	2,3 m	Solidum	€ 1.622	€ 1.787	€ 2.418						
PFMONO230NEO-COLOUR	2,3 m	Colorum	€ 1.782	€ 1.947	€ 2.579						

⁽¹⁾ Fixation on hard ground

⁽²⁾ Fixation in soft ground

⁽³⁾ Use on mobile parasol base

PARAFLEX STANDARD

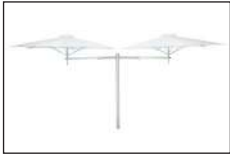

PARAFLEX DUO

PARAFLEX ROUND					
PRICE 2 X frame + 2 x canopy + 2 x NEO arm + multi pole & support + 2 x protection cover					
	Dimension	Fabric	Round support incl. ⁽¹⁾ UM-ROUNDSUPPORT-90	Concrete anchorage incl. ⁽²⁾ INGROUNDANCHORTYPE1	Mobile tile base incl. ⁽³⁾ TILEBASESTD-L-ALU
PFDUO270NEO-COLOUR	2,7 m	Solidum	€ 2.813	€ 2.978	€ 3.610
PFDUO270NEO-COLOUR	2,7 m	Colorum	€ 3.056	€ 3.221	€ 3.853
PFDUO300NEO-COLOUR	3 m	Solidum	€ 3.097	€ 3.262	€ 3.893
PFDUO300NEO-COLOUR	3 m	Colorum	€ 3.405	€ 3.570	€ 4.201

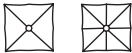
PARAFLEX SQUARE					
PRICE 2 X frame + 2 x canopy + 2 x NEO arm + multi pole & support + 2 x protection cover					
	Dimension	Fabric	Round support incl. ⁽¹⁾ UM-ROUNDSUPPORT-90	Concrete anchorage incl. ⁽²⁾ INGROUNDANCHORTYPE1	Mobile tile base incl. ⁽³⁾ TILEBASESTD-L-ALU
PFDUO200NEO-COLOUR	2 m	Solidum	€ 2.534	€ 2.699	€ 3.330
PFDUO200NEO-COLOUR	2 m	Colorum	€ 2.762	€ 2.927	€ 3.559
PFDUO230NEO-COLOUR	2,3 m	Solidum	€ 3.001	€ 3.166	€ 3.797
PFDUO230NEO-COLOUR	2,3 m	Colorum	€ 3.321	€ 3.486	€ 4.118



PARAFLEX MULTI 4

PARAFLEX ROUND					
PRICE 4 X frame + 4 x canopy + 4 x NEO arm + multi pole & support + 4 x protection cover					
	Dimension	Fabric	Round support incl. ⁽¹⁾ UM-ROUNDSUPPORT-90	Concrete anchorage incl. ⁽²⁾ INGROUNDANCHORTYPE1	Mobile tile base incl. ⁽³⁾ TILEBASESTD-L-ALU
PFMULTI270NEO-COLOUR	2,7 m	Solidum	€ 5.084	€ 5.249	€ 5.880
PFMULTI270NEO-COLOUR	2,7 m	Colorum	€ 5.569	€ 5.734	€ 6.366
PFMULTI300NEO-COLOUR	3 m	Solidum	€ 5.651	€ 5.816	€ 6.447
PFMULTI300NEO-COLOUR	3 m	Colorum	€ 6.267	€ 6.432	€ 7.064

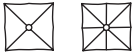
PARAFLEX SQUARE					
PRICE 4 X frame + 4 x canopy + 4 x NEO arm + multi pole & support + 4 x protection cover					
	Dimension	Fabric	Round support incl. ⁽¹⁾ UM-ROUNDSUPPORT-90	Concrete anchorage incl. ⁽²⁾ INGROUNDANCHORTYPE1	Mobile tile base incl. ⁽³⁾ TILEBASESTD-L-ALU
PFMULTI200NEO-COLOUR	2 m	Solidum	€ 4.525	€ 4.690	€ 5.321
PFMULTI200NEO-COLOUR	2 m	Colorum	€ 4.982	€ 5.147	€ 5.778
PFMULTI230NEO-COLOUR	2,3 m	Solidum	€ 5.459	€ 5.624	€ 6.256
PFMULTI230NEO-COLOUR	2,3 m	Colorum	€ 6.100	€ 6.265	€ 6.896

Note: for a Paraflex multi 5 configuration you do not need an additional arm, just a frame, canopy and pole top (+ protection cover)

Attention: To reduce its ecological footprint, Umbrosa no longer includes the tiles with the bases. We recommend our customers to source those locally.

TILEBASE = frame + cover + wheels – tiles not included





⁽¹⁾ Fixation on hard ground

⁽²⁾ Fixation in soft ground





⁽³⁾ Use on mobile parasol base

PARAFLEX STANDARD

MOUNTING OPTIONS

		Description	Price VAT excl.
PFARM-NEO		Paraflex Neo arm 2 m, wall mount (34 x 9 cm) and bolts included, contemporary design made of anodised aluminum - clean design.	€ 496
PFMONOPOLE-220		Single pole made of anodised aluminum - to be used with one umbrella holder.	€ 263
PFMULTIPOLE-230		Multi pole suitable for the fixation of two, three or four umbrella holders and one extra umbrella (with poletop).	€ 413
PFPOLETOP-MULTIPOLE		Poletop to install 5th Paraflex on a multi pole.	€ 62

MOUNTING OPTIONS AND BASES

		Description	Price VAT excl.
Hard ground		Round support straight 90° to install the MONO pole on a hard ground (concrete - wood) or on an Umbrosa base. Support is included in the Paraflex mono set (not included with the individual monopole).	€ 130
ROUNDSUPPORTTYPE1			
UM-ROUNDSUPPORT-90		Round support straight 90° to install the MULTI pole on a hard ground (concrete - wood) or on an Umbrosa base. Support is included in the Paraflex duo or multi set (not included with the individual multipole).	€ 130
Soft ground		Concrete anchorage straight 90° to install the pole in a "soft" ground pouring concrete. Used in combination with the support.	€ 165
INGROUNDANCHORTYPE1			
Tile base		Mobile large tile base set: tile base + cover + wheels in galvanized steel - 17,5 kg - 88,6 x 88,6 x 22 cm - cover ALU. Tiles not included.	€ 797
TILEBASESTD-L-ALU			
TILESET2N		Set of 12 concrete tiles: 40 x 40 x 3,8 cm for large tile base.	€ 238

REPLACEMENT CANOPIES - FRAMES - COMPONENTS

	Component	Shape	Dimension	Fabric	Price VAT excl.
PFCOVER270-COLOUR	CANOPY	ROUND	2,7 m	Solidum	€ 286
PFCOVER270-COLOUR				Colorum	€ 407
PFCOVER300-COLOUR			3 m	Solidum	€ 336
PFCOVER300-COLOUR				Colorum	€ 490
PFCOVER200-COLOUR		SQUARE	2 m	Solidum	€ 257
PFCOVER200-COLOUR				Colorum	€ 371
PFCOVER230-COLOUR			2,3 m	Solidum	€ 436
PFCOVER230-COLOUR				Colorum	€ 596
PFFRAME270	FRAME	ROUND	2,7 m		€ 278
PFFRAME300			3 m		€ 370
PFFRAME200		SQUARE	2 m		€ 167
PFFRAME230			2,3 m		€ 222
PFRIB270-PART	SPARE RIB		2,7 m		€ 92
PFRIB200-PART			2 m		€ 92
PFRIB300-PART			3 m		€ 92
PFRIB230-SHORT-PART			2,3 m short		€ 92
PFRIB230-LONG-PART			2,3 m long		€ 92
PFG RIP-NEOPART	GRIP FOR NEO ARM				€ 83
PFP PROTECTION	Cover bag one size! Fits all Paraflex models - stick included - the cover needs to be folded for smaller models. Material: Polyester.				€ 98



PARAFLEX UX

Production lead time: 3 weeks



PARAFLEX WALL

Price frame + canopy + NEO arm Black (RAL 9005) + protection cover		
	Dimension	Price VAT excl.
PFWALL200NEOBLACK_UX	2 m	€ 1.400
PFWALL230NEOBLACK_UX	2,3 m	€ 1.680

Paraflex UX combination

Material	
Canopy	Frame
Black	RAL9005 Black

Prices for replacement canopies, see standard collection.

PROTECTION COVER

	Description	Price VAT excl.
PFPROTECTION_UX	Cover bag Flanelle with fiberglass stick.	€ 192



PARAFLEX PX

Production lead time: 3 weeks

CHOOSE YOUR COMBINATION (ARM + FRAME ALWAYS FULL BLACK, RAL 9005)

1. SHAPE

2 x 2 m or 2,3 x 2,3 m

2. CANOPY COLOUR

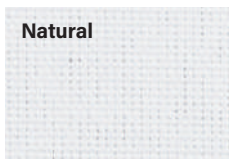

Natural

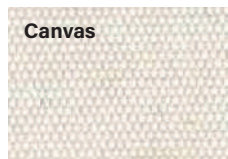

Canvas

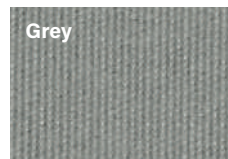

Grey

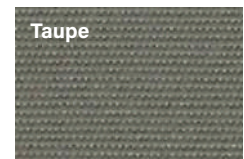

Taupe

<input checked="" type="checkbox"/>	2 x 2 m	PFCOVER200-NATURAL	PFCOVER200-CANVAS	PFCOVER200-GREY	PFCOVER200-TAUPE
<input checked="" type="checkbox"/>	2,3 x 2,3 m	PFCOVER230-NATURAL	PFCOVER230-CANVAS	PFCOVER230-GREY	PFCOVER230-TAUPE

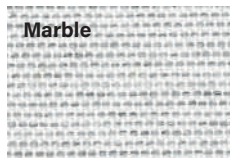

Marble

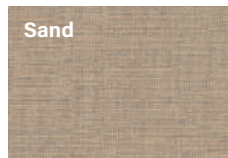

Sand

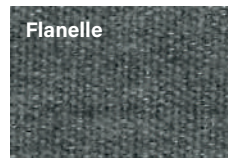

Flanelle

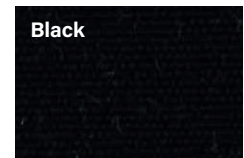

Black

<input checked="" type="checkbox"/>	2 x 2 m	PFCOVER200-MARBLE	PFCOVER200-SAND	PFCOVER200-FLANELLE	PFCOVER200-BLACK
<input checked="" type="checkbox"/>	2,3 x 2,3 m	PFCOVER230-MARBLE	PFCOVER230-SAND	PFCOVER230-FLANELLE	PFCOVER230-BLACK

Price frame + canopy + NEO arm Black (RAL 9005) + protection cover		
	Dimension	Price VAT excl.
PX model	2 x 2 m	€ 1.497
PX model	2,3 x 2,3 m	€ 1.777

Prices for replacement canopies, see standard collection.

Price for the protection cover, see UX collection.

PARAFLEX STANDARD

PARAFLEX UX

PARAFLEX PX

NEO

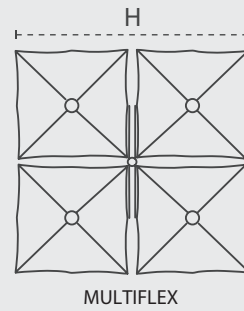
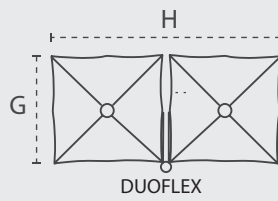
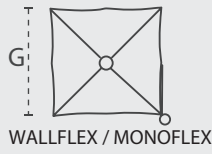
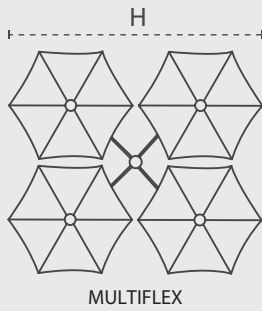
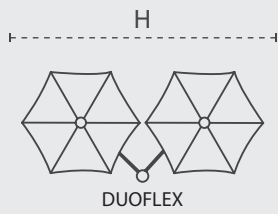
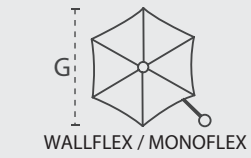
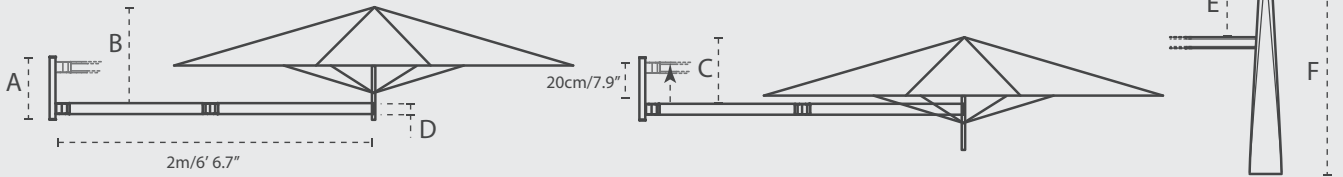

SINGLE POLE
(220 cm / 86 1/2")

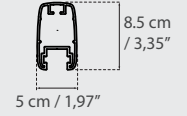

MULTI POLE
(230 cm / 90 1/2")

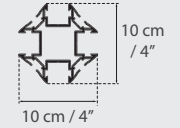

	$\pm 2\%$ +---+	A cm/inch	B cm/ft	C cm/ft	D cm/inch	E cm/ft	F cm/ft	G cm/ft	H cm/ft
	2.7m/8' 10.3"	34/13.4"	70/2' 3.5"	45/1' 6"	6/2.4"	50/1' 7.7"	135/4' 5"	270/8' 10.3"	540/17' 8.6"
	3m/9' 10"	34/13.4"	70/2' 3.5"	45/1' 6"	6/2.4"	50/1' 7.7"	150/4' 11"	300/9' 10"	600/19' 8"
	2.0m/6' 6.7"	34/13.4"	70/2' 3.5"	45/1' 6"	6/2.4"	50/1' 7.7"	135/4' 5"	200/6' 6.7"	400/13' 1.5"
	2.3m/7' 6.6"	34/13.4"	53/1' 8.9"	45/1' 6"	6/2.4"	40/1' 3.7"	163/5' 4"	230/7' 7"	460/15' 1"

SPECTRA

CONCEPT



Step into the world of the Spectra cantilever umbrella, a true master of versatility. With its unique shape, this cantilever umbrella offers an endless range of positions. The sleek design effortlessly combines beauty with functionality thanks to its innovative fan system. Instead of closing vertically, the umbrella closes horizontally. A revolutionary and contemporary concept that is unmatched.

DESIGNER

Dirk Wynants

USP

The very first truly beautiful, elegant and functional parasol.

SELLING TIPS

- Very wind resistant thanks to the fiberglass ribs
- 180° fan system, easy to open and close
- The canopy can be fixed in different positions according to the position of the sun
- Pole rotates 360° around its axis.
- Spectra "forward (80°)" creates space between base and furniture.

VERSIONS

SPECTRA STANDARD



RAL 9005

RAL 1013

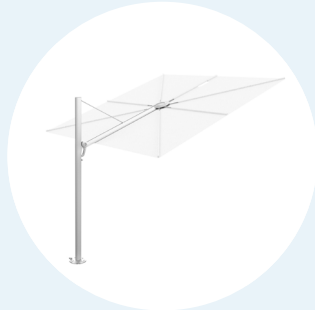

STRAIGHT 90°

2,5 x 2,5 m
3 x 3 m

From € 2.305



FORWARD 80°

2,5 x 2,5 m
3 x 3 m

From € 2.305



DUO

2,5 x 5,4 m

From € 4.911

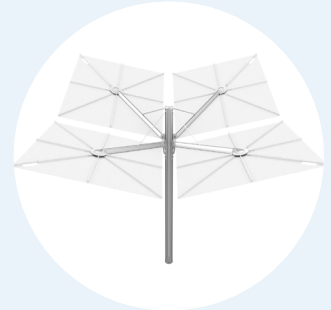

MULTI

5,4 x 5,4 m

From € 9.814

QUICK SHIP

PRODUCTION TIME, COLOURS AND MODELS												
SPECTRA COLOUR	SOLIDUM				COLORUM							
	Natural	Canvas	Grey	Taupe	Marble	Mint	Blush	Pepper	Almond	Sand	Flanelle	Black
SPECTRA SQUARE	QS	QS	QS	3	3	3	3	3	3	3	3	QS
SPECTRA DUO/MULTI	3	3	3	3	3	3	3	3	3	3	3	3

QS = 3 days / 3 = 3 weeks production time

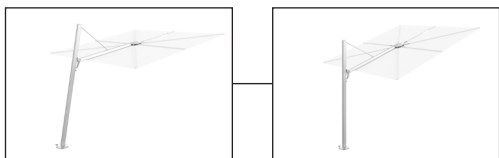

SPECTRA FORWARD AND STRAIGHT | ALU | 2,5 M

PRICE ALU frame + canopy + round support + protection cover					
	Pole	Fabric	⁽¹⁾	Concrete anchorage incl. ⁽²⁾ INGROUNDANCHORTYPE1	Mobile base incl. ⁽³⁾ TILEBASESTD-L-ALU
SP250ALUN80F-COLOUR	80°	Solidum	€ 2.305	€ 2.470	€ 3.102
SP250ALUN90S-COLOUR	90°				
SP250ALUN80F-COLOUR	80°	Colorum	€ 2.465	€ 2.631	€ 3.262
SP250ALUN90S-COLOUR	90°				

⁽¹⁾ Fixation on hard ground

⁽²⁾ Fixation in soft ground

⁽³⁾ Use on mobile parasol base

For easy mounting, order spacer in addition!



SPECTRA STANDARD

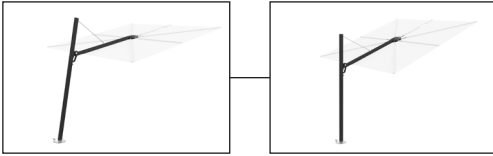

SPECTRA FORWARD AND STRAIGHT | BLACK | 2,5 M

PRICE BLACK frame (RAL 9005) + canopy + round support + protection cover

	Pole	Fabric	⁽¹⁾	Concrete anchorage incl. ⁽²⁾ INGROUNDANCHORTYPE1	Mobile base incl. ⁽³⁾ TILEBASESTD-L-BLACK
SP250BLACKN80F-COLOUR	80°	Solidum	€ 2.642	€ 2.807	€ 3.509
SP250BLACKN90S-COLOUR	90°				
SP250BLACKN80F-COLOUR	80°	Colorum	€ 2.802	€ 2.967	€ 3.669
SP250BLACKN90S-COLOUR	90°				

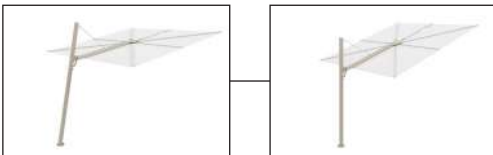

SPECTRA FORWARD AND STRAIGHT | BEIGE LIMESTONE | 2,5 M

PRICE BEIGE LIMESTONE frame (RAL 1013) + canopy + round support + protection cover

	Pole	Fabric	⁽¹⁾	Concrete anchorage incl. ⁽²⁾ INGROUNDANCHORTYPE1	Mobile base incl. ⁽³⁾ TILEBASESTD-L-LIME
SP250LIMEN80F-COLOUR	80°	Solidum	€ 2.642	€ 2.807	€ 3.509
SP250LIMEN90S-COLOUR	90°				
SP250LIMEN80F-COLOUR	80°	Colorum	€ 2.802	€ 2.967	€ 3.669
SP250LIMEN90S-COLOUR	90°				



SPECTRA FORWARD AND STRAIGHT | ALU | 3 M

PRICE ALU frame + canopy + round support + protection cover

	Pole	Fabric	⁽¹⁾	Concrete anchorage incl. ⁽²⁾ INGROUNDANCHORTYPE1	Mobile base incl. ⁽³⁾ TILEBASESTD-L-ALU
SP300ALUN80F-COLOUR	80°	Solidum	€ 2.744	€ 2.909	€ 3.540
SP300ALUN90S-COLOUR	90°				
SP300ALUN80F-COLOUR	80°	Colorum	€ 2.943	€ 3.108	€ 3.739
SP300ALUN90S-COLOUR	90°				

⁽¹⁾ Fixation on hard ground

⁽²⁾ Fixation in soft ground

⁽³⁾ Use on mobile parasol base

For easy mounting, order spacer in addition!

SPECTRA STANDARD



SPECTRA FORWARD AND STRAIGHT | BLACK | 3M

PRICE **BLACK** frame (RAL 9005) + canopy + round support + protection cover

	Pole	Fabric	⁽¹⁾	Concrete anchorage incl. ⁽²⁾ INGROUNDANCHORTYPE1	Mobile base incl. ⁽³⁾ TILEBASESTD-L-BLACK
SP300BLACKN80F-COLOUR	80°	Solidum	€ 3.121	€ 3.286	€ 3.988
SP300BLACKN90S-COLOUR	90°				
SP300BLACKN80F-COLOUR	80°	Colorum	€ 3.320	€ 3.485	€ 4.187
SP300BLACKN90S-COLOUR	90°				



SPECTRA FORWARD AND STRAIGHT | BEIGE LIMESTONE | 3M

PRICE **BEIGE LIMESTONE** frame (RAL 1013) + canopy + round support + protection cover

	Pole	Fabric	⁽¹⁾	Concrete anchorage incl. ⁽²⁾ INGROUNDANCHORTYPE1	Mobile base incl. ⁽³⁾ TILEBASESTD-L-LIME
SP300LIMEN80F-COLOUR	80°	Solidum	€ 3.121	€ 3.286	€ 3.988
SP300LIMEN90S-COLOUR	90°				
SP300LIMEN80F-COLOUR	80°	Colorum	€ 3.320	€ 3.485	€ 4.187
SP300LIMEN90S-COLOUR	90°				

⁽¹⁾ Fixation on hard ground

⁽²⁾ Fixation in soft ground

⁽³⁾ Use on mobile parasol base

For easy mounting, order spacer in addition!

SPECTRA STANDARD

STRAIGHT -90°

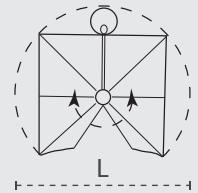
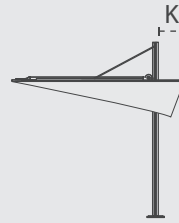
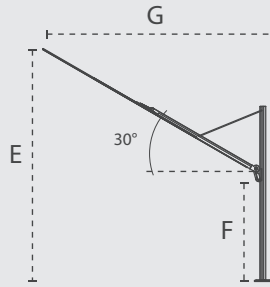
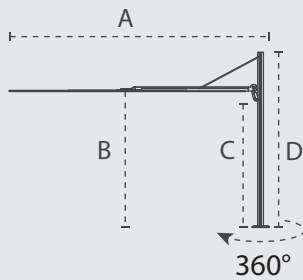

FORWARD -80°

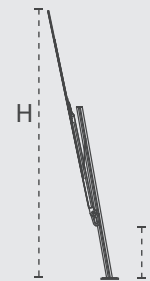
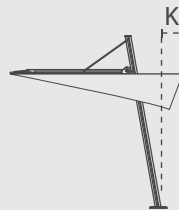
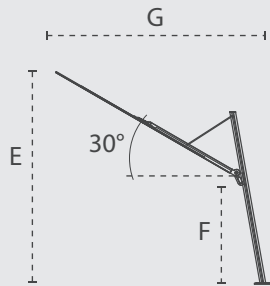
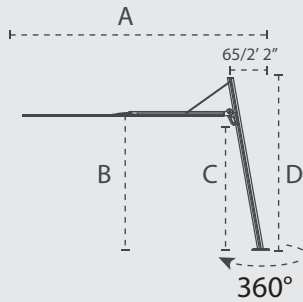

	A cm/ft	B cm/ft	C cm/ft	D cm/ft	E cm/ft	F cm/ft	G cm/ft	H cm/ft	I cm/ft	J cm/ft	K cm/ft	L cm/ft
Straight 2.5m/8' 2" +/- 2% F-----I	295/9' 8"	200/6' 7"	185/6' 1"	260/8' 7"	270/8' 10.3"	135/4' 5"	240/7' 10.5"	360/11' 10"	90/2' 11"	260/8' 7"	35/1' 1.8"	370/12' 2"
3m/9' 10"	345/11' 4"	205/6' 9"	185/6' 1"	260/8' 7"	280/9' 2"	140/4' 7"	250/8' 2.4"	400/13' 2"	80/2' 8"	270/8' 10"	50/1' 7.7"	435/14' 3"
Forward 2.5m/8' 2" +/- 2% F-----I	330/10' 10"	195/6' 5"	180/5' 11"	255/8' 8"	270/8' 10.3"	135/4' 5"	305/10'	350/11' 6"	90/2' 11"	260/8' 7"	0/0"	370/12' 2"
3m/9' 10"	380/12' 6"	195/6' 5"	180/5' 11"	255/8' 8"	280/9' 2"	140/4' 7"	315/10' 4"	390/12' 10"	80/2' 8"	260/8' 7"	5/1.97"	435/14' 3"

Attention: To reduce its ecological footprint, Umbrosa no longer includes the tiles with the bases. We recommend our customers to source those locally.
 TILEBASE = frame + cover + wheels - tiles not included



DUO SPECTRA | ALU | 2,5 X 5,4 M

PRICE 2 X ALU frame + 2 x canopy + round support + protection cover				
	Fabric	⁽¹⁾	Concrete anchorage incl. ⁽²⁾ INGROUNDANCHORTYPE1	Mobile base incl. ⁽³⁾ TILEBASESTD-L-ALU
SPDUOALUN-COLOUR	Solidum	€ 4.911	€ 5.077	€ 5.708
SPDUOALUN-COLOUR	Colorum	€ 5.056	€ 5.221	€ 5.853

⁽¹⁾ Fixation on hard ground ⁽²⁾ Fixation in soft ground ⁽³⁾ Use on mobile parasol base
 For easy mounting, order spacer in addition!

SPECTRA STANDARD



DUO SPECTRA | BLACK | 2,5 X 5,4 M

PRICE 2 X **BLACK** frame (RAL 9005) + 2 x canopy + round support + protection cover

	Fabric	⁽¹⁾	Concrete anchorage incl. ⁽²⁾ INGROUNDANCHORTYPE1	Mobile tile base incl. ⁽³⁾ TILEBASESTD-L-BLACK
SPDUOLACKN-COLOUR	Solidum	€ 5.567	€ 5.732	€ 6.434
SPDUOLACKN-COLOUR	Colorum	€ 5.712	€ 5.877	€ 6.579



DUO SPECTRA | BEIGE LIMESTONE | 2,5 X 5,4 M

PRICE 2 X **BEIGE LIMESTONE** frame (RAL 1013) + 2 x canopy + round support + protection cover

	Fabric	⁽¹⁾	Concrete anchorage incl. ⁽²⁾ INGROUNDANCHORTYPE1	Mobile tile base incl. ⁽³⁾ TILEBASESTD-L-LIME
SPDUOLIMEN-COLOUR	Solidum	€ 5.567	€ 5.732	€ 6.434
SPDUOLIMEN-COLOUR	Colorum	€ 5.712	€ 5.877	€ 6.579

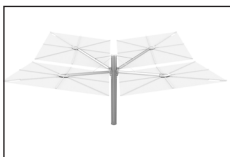

MULTI SPECTRA | ALU | 5,4 X 5,4 M

PRICE 4 X **ALU** frame + 4 x canopy + support + protection cover

	Fabric	⁽¹⁾	Concrete anchorage incl. ⁽²⁾ INGROUNDANCHORTYPE1	Mobile tile base incl. ⁽³⁾ TILEBASESTD-L-ALU
SPMULALUN-COLOUR	Solidum	€ 9.814	€ 9.980	€ 10.611
SPMULALUN-COLOUR	Colorum	€ 10.104	€ 10.269	€ 10.901

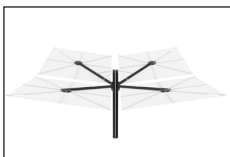

MULTI SPECTRA | BLACK | 5,4 X 5,4 M

PRICE 4 X **BLACK** frame (RAL 9005) + 4 x canopy + support + protection cover

	Fabric	⁽¹⁾	Concrete anchorage incl. ⁽²⁾ INGROUNDANCHORTYPE1	Mobile tile base incl. ⁽³⁾ TILEBASESTD-L-BLACK
SPMULBLACKN-COLOUR	Solidum	€ 11.136	€ 11.302	€ 12.003
SPMULBLACKN-COLOUR	Colorum	€ 11.426	€ 11.591	€ 12.293

⁽¹⁾ Fixation on hard ground ⁽²⁾ Fixation in soft ground ⁽³⁾ Use on mobile parasol base
For easy mounting, order spacer in addition!

SPECTRA STANDARD



MULTI SPECTRA | BEIGE LIMESTONE | 5,4 X 5,4 M

PRICE 4 X BEIGE LIMESTONE frame (RAL 1013) + 4 x canopy + support + protection cover				
	Fabric	⁽¹⁾	Concrete anchorage incl. ⁽²⁾ INGROUNDANCHORTYPE1	Mobile tile base incl. ⁽³⁾ TILEBASESTD-L-LIME
SPMULTILIMEN-COLOUR	Solidum	€ 11.136	€ 11.302	€ 12.003
SPMULTILIMEN-COLOUR	Colorum	€ 11.426	€ 11.591	€ 12.293

+/- 2% -----	A	B	C	D	E	F	G	J	I	M	M'	N	N'
	cm/ft	cm/ft	cm/ft	cm/ft	cm/ft	cm/ft	cm/ft	cm/ft	cm/ft	cm/ft	cm/ft	cm/ft	cm/ft
Spectra Duo	253/8' 4"	197/6' 6"	187/6' 2"	260/8' 7"	340/11' 2"	135/4' 5"	210/6' 10.7"	270/8' 10"	50/1' 7.7"	540/17' 9"	644/21' 2"	285/9' 4"	337/11' 1"
Spectra Multi	253/8' 4"	197/6' 6"	187/6' 2"	260/8' 7"	340/11' 2"	140/4' 7"	210/6' 10.7"	270/8' 10"	50/1' 7.7"	540/17' 9"	644/21' 2"	540/17' 9"	644/21' 2"

Attention: To reduce its ecological footprint, Umbrosa no longer includes the tiles with the bases. We recommend our customers to source those locally.

TILEBASE = frame + cover + wheels - tiles not included

⁽¹⁾ Fixation on hard ground







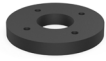

⁽²⁾ Fixation in soft ground

⁽³⁾ Use on mobile parasol base

For easy mounting, order spacer in addition!

SPECTRA STANDARD

MOUNTING OPTIONS AND BASES

		Description	Finish	Price VAT excl.
Hard ground				
SPACER1		When you want to install the umbrella on a solid surface, it is recommended to order a spacer so that you don't have to make a cutout in the surface.	HDPE	€ 63
Soft ground				
INGROUNDANCHORTYPE1		Concrete anchorage to install the pole in a "soft" ground pouring concrete. To use in combination with a round support.	Galvanized steel	€ 165
Extension kit				
SPEXTKIT-ALUN		Spectra extension kit 15 cm - to increase the height - heavy duty piece included. The extension kit is recommended for installation of the pole direct to the floor or in the ground, not for installation on a tile base (max. 2 pieces).	Alu	€ 145
SPEXTKIT-BLACKN			Black (RAL 9005)	€ 180
SPEXTKIT-LIMEN			Beige limestone (RAL 1013)	€ 180
Mobile bases				
TILEBASESTD-L-ALU		Full large tile base: base - cover - wheels in galvanized steel - 17,5 kg - 88,6 x 88,6 x 22 cm Tiles not included.	Cover: Alu	€ 797
TILEBASESTD-L-BLACK			Cover: Black (RAL 9005)	€ 867
TILEBASESTD-L-LIME			Cover: Beige Limestone (RAL 1013)	€ 867
TILESET2N		Set of 12 concrete tiles - 40 x 40 x 3,8 cm - for large tile base - weight 178 kg.		€ 238

REPLACEMENT CANOPIES AND COVER BAGS

	Dimensions	Fabric	Price VAT excl.
SP250COVERN-COLOUR	2,5 x 2,5 m	Solidum	€ 757
SP250COVERN-COLOUR		Colorum	€ 845
SP300COVERN-COLOUR	3 x 3 m	Solidum	€ 919
SP300COVERN-COLOUR		Colorum	€ 1118
SPDUOMULCOVERN-COLOUR	DUO / MULTI	Solidum	€ 923
SPDUOMULCOVERN-COLOUR		Colorum	€ 996
SPPROTECTION	2,5 and 3 m	Cover bag in polyester with fiberglass stick.	€ 125
SPDUO-PROTECTION	DUO		€ 252
SPMULTI-PROTECTION	MULTI		€ 293

ICARUS

CONCEPT



With the Icarus, Umbrosa hits two birds with one stone. Inspired by nature, we have designed an umbrella that also serves as a windscreen. The Icarus embraces and protects. It creates the safe shelter of a cocoon while allowing you to fully enjoy the beautiful weather.

DESIGNER

Umbrosa design team

USP

The only parasol that can also be used as a windshield and that creates the ultimate cocoon with its unique and natural shape.

SELLING TIPS

- Extremely wind resistant parasol
- Large shaded area thanks to 360° rotation and height adjustment of the parasol
- Easy to use and ergonomic
- Cosy cocoon

VERSIONS

ICARUS STANDARD

ALU



3 m

From € 3.432

ICARUS UX

BLACK
RAL 9005

BEIGE
LIMESTONE
RAL 1013



FULL BLACK

From € 4.174



SAND

From € 4.174

ICARUS PX

BLACK
RAL 9005

BEIGE
LIMESTONE
RAL 1013



ICARUS PX

From € 4.424

Icarus PX freely combinable:
1 size, 2 frame colours, 8 fabric colours

NEW

CANOPY COLOURS

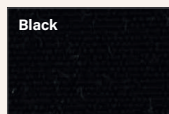

Black



Marble

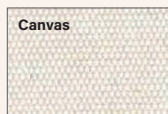

Canvas

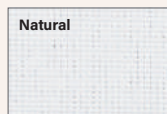

Natural

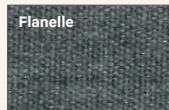

Flanelle

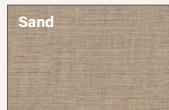

Sand

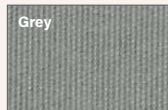

Grey



Taupe



ICARUS STANDARD

QUICK SHIP

PRODUCTION TIME, COLOURS AND MODELS

ICARUS COLOUR	SOLIDUM				COLORUM							
	Natural	Canvas	Grey	Taupe	Marble	Mint	Blush	Pepper	Almond	Sand	Flanelle	Black
ICARUS 3X3M	QS	3	3	3	3	3	3	3	3	3	3	3

QS = 3 days / 3 = 3 weeks production time



ICARUS | ALU | 3 M

PRICE ALU frame + canopy + round support + protection cover

	Fabric	⁽¹⁾	Concrete anchorage incl. ⁽²⁾ INGROUNDANCHORTYPE1	Mobile base incl. ⁽³⁾ TILEBASESTD-L-ALU
ICARUS2N-COLOUR	Solidum	€ 3.432	€ 3.598	€ 4.229
ICARUS2N-COLOUR	Colorum	€ 3.613	€ 3.778	€ 4.409

MOUNTING OPTIONS AND BASES

		Description	Finish	Price VAT excl.
Hard ground		When you want to install the umbrella on a solid surface, it is recommended to order a spacer so that you don't have to make a cutout in the surface.	HDPE	€ 63
SPACER1				
Soft ground		Concrete anchorage to install the pole in a "soft" ground pouring concrete. To use in combination with a round support.	Galvanized steel	€ 165
INGROUNDANCHORTYPE1				
Mobile base		Full large tile base set ALU: base-cover-wheels - galvanized steel - 17,5 kg - 88,6 x 88,6 x 22 cm. Tiles not included.	Cover: Alu	€ 797
TILEBASESTD-L-ALU				
TILESET2N		Set of 12 concrete tiles - 40 x 40 x 3,8 cm - for large tile base - weight 178 kg.		€ 238

REPLACEMENT CANOPIES AND COVER BAG

	Fabric	Price VAT excl.
ICARUSCOVER2N-COLOUR	Solidum	€ 709
ICARUSCOVER2N-COLOUR	Colorum	€ 826
ICARUSPROTECTION	Cover bag in polyester with fiberglass stick.	€ 134

⁽¹⁾ Fixation on hard ground

⁽²⁾ Fixation in soft ground

⁽³⁾ Use on mobile parasol base

For easy mounting, order spacer in addition!



ICARUS UX

Production lead time: 3 weeks

PRICE frame + canopy + support + protection cover				
	Dimension	⁽¹⁾	Concrete anchorage incl. ⁽²⁾ INGROUNDANCHORTYPE1	Mobile base incl. ⁽³⁾
ICARUSSAND2N_UX	3 m	€ 4.174	€ 4.339	€ 5.397 TILEBASEUX-LSAND
ICARUSFULLBLACK2N_UX	3 m			€ 5.397 TILEBASEUX-L-BLACK

Icarus UX combination

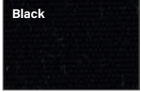
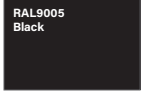



Material	
Canopy 	Frame + Base 

FULL BLACK

Material		
Canopy 	Frame + Base 	Cover base * 

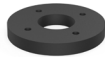
SAND

MOUNTING OPTIONS AND BASES

		Description	Finish	Price VAT excl.
Hard ground		When you want to install the umbrella on a solid surface, it is recommended to order a spacer so that you don't have to make a cutout in the surface.	HDPE	€ 63
SPACER1				
Soft ground		Concrete anchorage to install the pole in a "soft" ground pouring concrete. To use in combination with a round support.	Galvanized steel	€ 165
INGROUNDANCHORTYPE1				
Mobile bases		Mobile large UX base set: base - cover (Thermo Poplar) - wheels 32 kg - 88,8 x 88,8 x 22 cm (Black), 88,8 x 88,8 x 24 cm (Sand). Tiles not included.	Sand - RAL 1013 Beige Limestone. Cover in wood (Thermo Poplar)*.	€ 1.223
TILEBASEUX-L-SAND			Black - RAL 9005	
TILEBASEUX-L-BLACK				
TILESET2N		Set of 12 concrete tiles, required for the large UX tile base. 4 tiles will need a corner to be cut out (see installation manual).		€ 238

* Our UX wooden covers are made of thermotreated poplar wood that has not been treated for colour stability. The wood will weather with outdoor exposure and turn grey.

⁽¹⁾ Fixation on hard ground

⁽²⁾ Fixation in soft ground

⁽³⁾ Use on mobile parasol base

For easy mounting, order spacer in addition!

ICARUS UX

PROTECTION COVER

	Description	Price VAT excl.
ICPROTECTION_UX	Cover bag Flanelle with fiberglass stick	€ 243

Price for the protection cover, see UX collection.

ICARUS PX

Production lead time: 3 weeks

NEW

CHOOSE YOUR COMBINATION

QR code to spec sheet



1. FRAME COLOUR

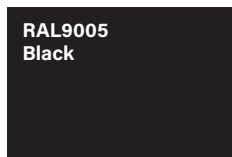

ICFRAMEBLACK_UX

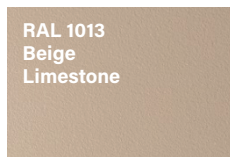

ICFRAMELIME_UX

2. CANOPY COLOUR

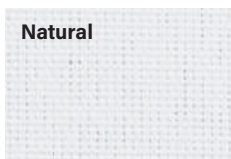

ICARUSCOVER2N-NATUR

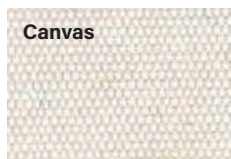

ICARUSCOVER2N-CANV

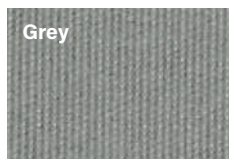

ICARUSCOVER2N-GREY



ICARUSCOVER2N-TAUPE

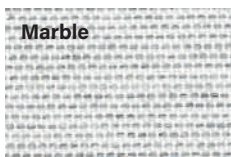

ICARUSCOVER2N-MARB

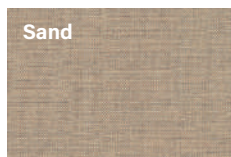

ICARUSCOVER2N-SAND



ICARUSCOVER2N-FLANE

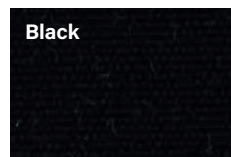

ICARUSCOVER2N-BLACK

ICARUS PX

4. BASE

A. Top plate

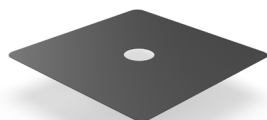

RAL9005
Black
BLACBASETOPPLATEUX



RAL1013
Beige Limestone
LIMEBASETOPPLATEUX



Thermo
Poplar *
WOODBASETOPPLATEUX

B. Frame base



RAL9005
Black
BLACBASEFRAMEUX



RAL1013
Beige Limestone
LIMEBASEFRAMEUX

PRICE PX frame + canopy + support + protection cover				
	Dimension	⁽¹⁾	Concrete anchorage incl. ⁽²⁾ INGROUNDANCHORTYPE1	Mobile base incl. ⁽³⁾
ICARUS PX	3 m	€ 4,424	€ 4,589	€ 5,647

* Our UX wooden covers are made of thermotreated poplar wood that has not been treated for colour stability. The wood will weather with outdoor exposure and turn grey.

Prices for replacement canopies, see standard collection.

Price for the protection cover, see UX collection.

⁽¹⁾ Fixation on hard ground
For easy mounting, order spacer in addition!

⁽²⁾ Fixation in soft ground

⁽³⁾ Use on mobile parasol base

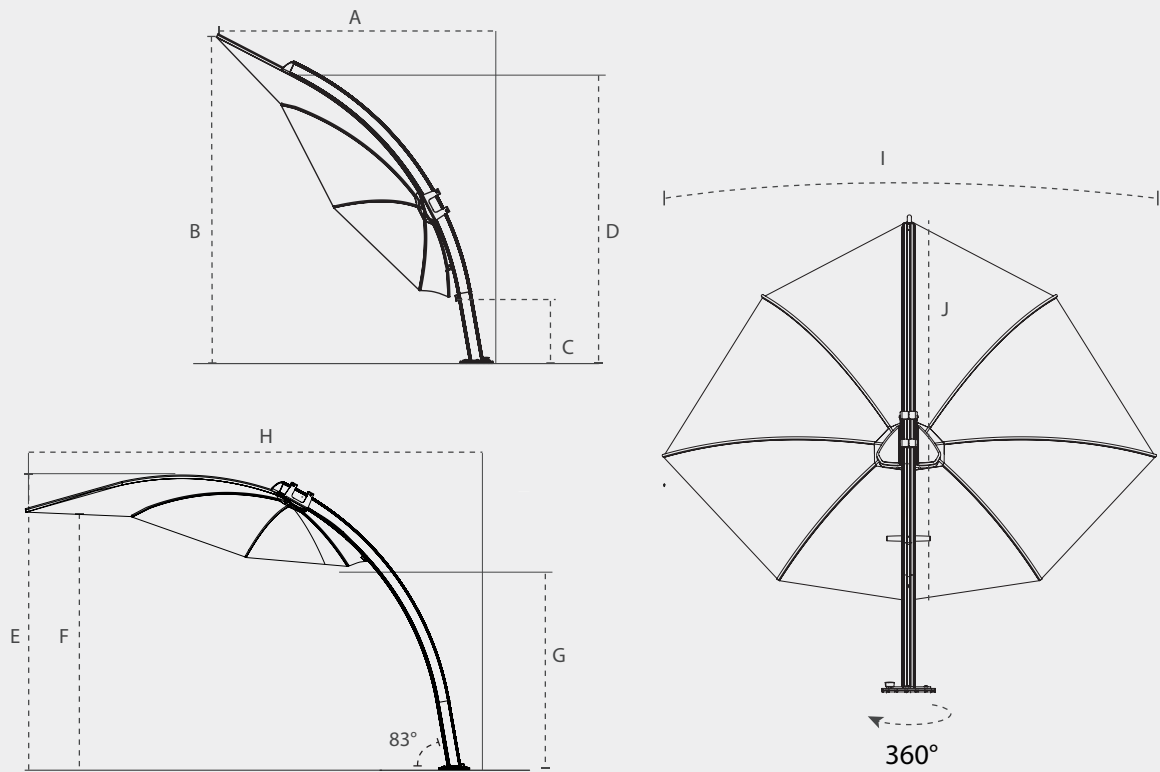

+/- 2%	A	B	C	D	E	F	G	H	I	J
cm/ft	cm/ft	cm/ft	cm/ft	cm/ft	cm/ft	cm/ft	cm/ft	cm/ft	cm/ft	cm/ft
Icarus	255/8' 4.4"	260/8' 6.4"	44/17.3"	240/7' 10.5"	260/8' 6.4"	250/8' 2.4"	150/59"	380/4' 5.6"	300/9' 10"	300/9' 10"

Attention: To reduce its ecological footprint, Umbrosa no longer includes the tiles with the bases. We recommend our customers to source those locally.

TILEBASE = frame + cover + wheels - tiles not included

VERSA

CONCEPT

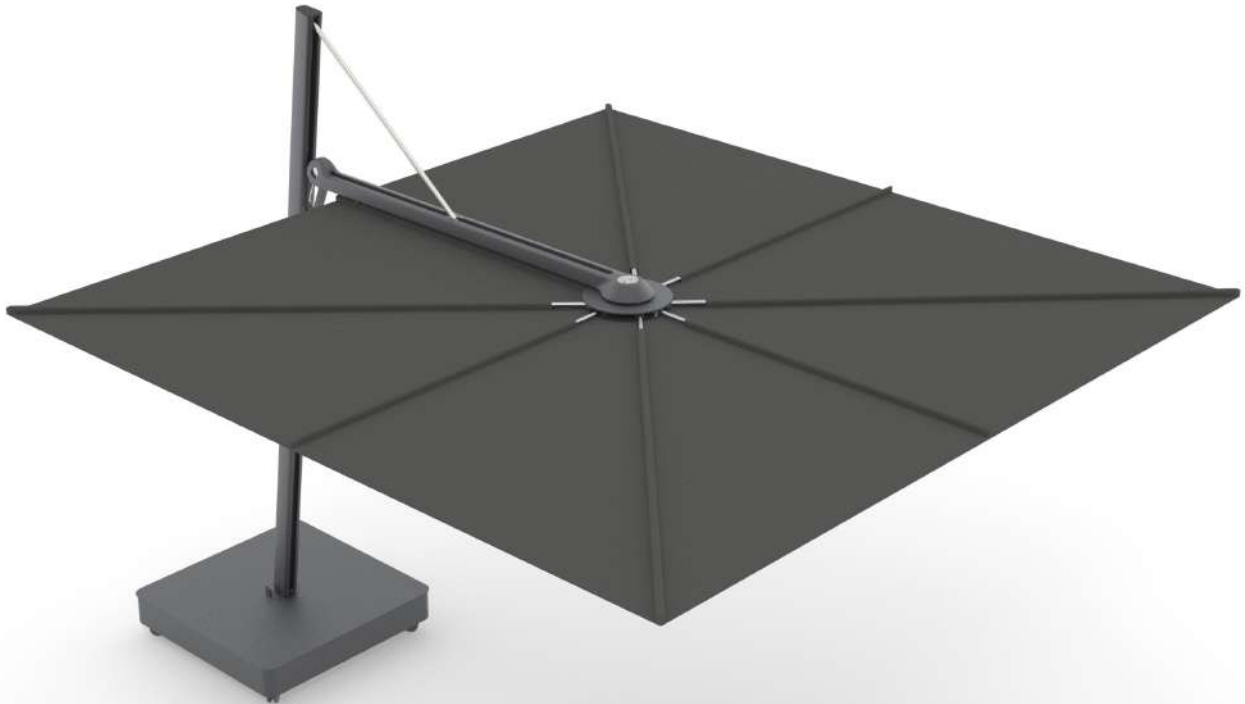

Outdoor trends are moving towards a real outdoor living space where everything has to be cosy, beautiful and functional at the same time. Furniture is chosen in function of the interior, the windows, the garden, the colours, etc. Parasols must also fit in perfectly. The UX collection includes five unique combinations, the PX collection allows you to compose your own parasol.

DESIGNER

Dirk Wynants and Umbrosa Design Team

USP

The impressive combination of luxury and sophistication in a robust and particularly user-friendly parasol.

SELLING TIPS

- 360° fan concept - easy to open and close
- Height adjustable with one hand
- Rotation system (360°) is nicely integrated into the elegant parasol base
- Robust and extremely wind resistant (glass fiber ribs)
- Leans slightly forward (80°) in order to create space between the furniture and base

VERSIONS

VERSA UX

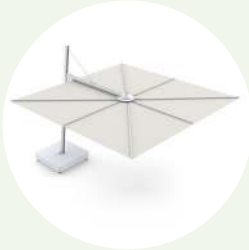

ARCHITECTURE

From € 3.841

3 x 3 m



FULL BLACK

From € 3.841

3 x 3 m

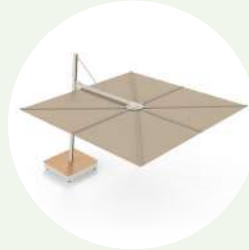

SAND

From € 3.841

3 x 3 m



LATTE

From € 3.841

Ø 3,5 m



SAFARI

From € 3.841

Ø 3,5 m

VERSA PX



VERSA PX

From € 4.091

Versa PX freely combinable: 2 sizes, 5 frame colours, 8 fabric colours

FRAME COLOURS



**RAL 9018
Papyrus
white**

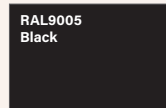

**RAL 9005
Black**



**RAL 1013
Beige
Limestone**



**RAL 1019
Grey Beige**

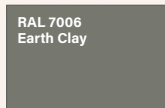

**RAL 7006
Earth Clay**

FABRIC COLOURS

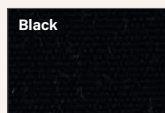

Black



Marble

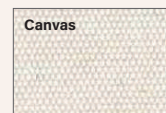

Canvas

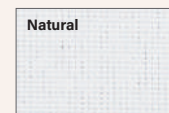

Natural



Flanelle

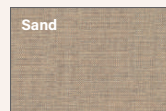

Sand

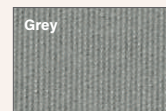

Grey



Taupe





VERSA UX

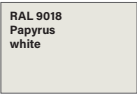
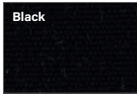
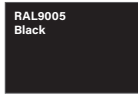

Production lead time: 3 weeks

PRICE frame + canopy + support + protection cover				
	Dimension	⁽¹⁾	Concrete anchorage incl. ⁽²⁾ INGROUNDANCHORTYPE1	Mobile base incl. ⁽³⁾
VEARCHITECTURE_UX	3 x 3 m	€ 3.841	€ 4.007	TILEBASEUX-L-ARCHI
VEFULLBLACK_UX	3 x 3 m			TILEBASEUX-L-BLACK
VESAND_UX	3 x 3 m			TILEBASEUX-L-SAND
VELAT350RO_UX	Ø 3,5 m			TILEBASEUX-L-LATTE
VESAF350RO_UX	Ø 3,5 m			TILEBASEUX-L-SAFARI

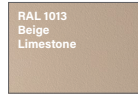
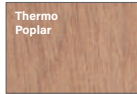
UX combinations square

Material		Material		Material		
Canopy	Frame + Base	Canopy	Frame + Base	Canopy	Frame + Base	Cover base*
						
ARCHITECTURE		FULL BLACK		SAND		

UX combinations round

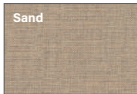
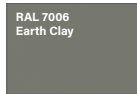
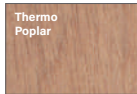
Material			Material		
Canopy	Frame + Base	Cover base*	Canopy	Frame + Base	Cover base*
					
LATTE			SAFARI		

* Our UX wooden covers are made of thermotreated poplar wood that has not been treated for colour stability. The wood will weather with outdoor exposure and turn grey.

REPLACEMENT CANOPIES AND PROTECTION COVER

	Description	Price VAT excl.
VE300SQCOVERMARB_UX	3 x 3 m Marble	€ 1.154
VE300SQCOVERBLACK_UX	3 x 3 m Black	
VE300SQCOVERSAND_UX	3 x 3 m Sand	
VE350ROCOVERCANV_UX	Ø 3,5 m Canvas	
VE350ROCOVERSAND_UX	Ø 3,5 m Sand	
VEPROTECTION_UX	Cover bag Flanelle with fiberglass stick.	€ 243

⁽¹⁾ Fixation on hard ground



⁽²⁾ Fixation in soft ground

⁽³⁾ Use on mobile parasol base

For easy mounting, order spacer in addition!

VERSA UX

MOUNTING OPTIONS AND BASES

		Description	Finish	Price VAT excl.
Hard ground		When you want to install the umbrella on a solid surface, it is recommended to order a spacer so that you don't have to make a cutout in the surface.	HDPE	€ 63
SPACER1				
Soft ground		Concrete anchorage to install the pole in a "soft" ground pouring concrete. To use in combination with a round support.		€ 165
INGROUNDANCHORTYPE1				
Mobile bases		Mobile large UX tile base: base - cover* - wheels - 32 kg - 88,8 x 88,8 x 22 cm (Sand, Latte, Safari: 88,8 x 88,8 x 24 cm). Tiles not included	Papyrus White - RAL 9018	€ 1.223
TILEBASEUX-L-ARCHI			Black - RAL 9005	
TILEBASEUX-L-BLACK			Sand - RAL 1013 Beige Limestone. Cover in wood (Thermo Poplar).	
TILEBASEUX-L-SAND			Latte - Grey Beige RAL 1019. Cover in wood (Thermo Poplar).	
TILEBASEUX-L-LATTE			Safari - Earth Clay RAL 7006. Cover in wood (Thermo Poplar).	
TILEBASEUX-L-SAFARI				
TILESET2N		Set of 12 concrete tiles, required for the large UX tile base. 4 tiles will need a corner to be cut out (see installation manual).		€ 238

* Our UX wooden covers are made of thermotreated poplar wood that has not been treated for colour stability. The wood will weather with outdoor exposure and turn grey.

EXTENSION KIT (EXTENSIONKIT)

		Description	UX version	Price VAT excl.
VEEXTKIT-PAPY		Versa UX extension kit 15 cm - heavy duty piece included. The extension kit is recommended for installation of the pole direct to the floor or in the ground, not for installation on a UX base.	ARCHI	€ 194
VEEXTKIT-BLACK			FULL BLACK	
VEEXTKIT-LIME			SAND	
VEEXTKIT-GREYB			LATTE	
VEEXTKIT-EARTH			SAFARI	



VERSA PX

VERSA PX | 3 X 3 M | Ø 3,5 M | 80°

CHOOSE YOUR COMBINATION

1. SHAPE

SQUARE



ROUND



1. FRAME COLOUR

RAL 9018
Papyrus
white

RAL9005
Black

RAL 1013
Beige
Limestone

RAL 1019
Grey Beige

RAL 7006
Earth Clay



VEFRAMEPAPY_UX

VEFRAMEBLACK_UX

VEFRAMELIME_UX

VEFRAMEGREYB_UX

VEFRAMEEARTH_UX



VEFRAME350ROPAPY_UX

VEFRAME350ROBLACK_UX

VEFRAME350ROLIME_UX

VEFRAME350ROGREYB_UX

VEFRAME350ROEARTH_UX

2. CANOPY COLOUR

Natural

Canvas

Grey

Taupe



VE300COVERNAT_UX

VE300COVERCANV_UX_R

VE300COVERGREY_UX

VE300COVERTAUPE_UX



VE350ROCOVERNAT_UX

VE350ROCOVERCANV_UX

VE350ROCOVERGREY_UX

VE350ROCOVERTAUPE_UX

Marble

Sand

Flanelle

Black



VE300COVERMARB_UX

VE300COVERSAND_UX_R

VE300COVERFLAN_UX

VE300COVERBLACK_UX



VE350ROCOVERMARB_UX

VE350ROCOVERSAND_UX

VE350ROCOVERFLAN_UX

VE350ROCOVERBLACK_UX

VERSA PX

4. BASE

A. Top plate



RAL9018
Papyrus white
PAPYBASETOPPLATEUX

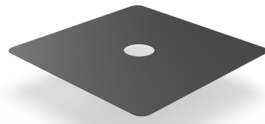

RAL9005
Black
BLACBASETOPPLATEUX



RAL1013
Beige Limestone
LIMEBASETOPPLATEUX



Thermo
Poplar*
WOODBASETOPPLATEUX

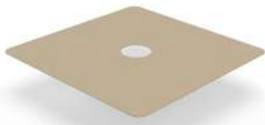

RAL1019
Grey Beige
GREYBBASETOPPLATEUX

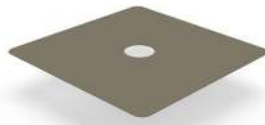

RAL7006
Earth Clay
EARTHBASETOPPLATEUX

B. Frame base



RAL 9018
Papyrus white
PAPYBASEFRAMEUX



RAL9005
Black
BLACBASEFRAMEUX



RAL1013
Beige Limestone
LIMEBASEFRAMEUX



RAL1019
Grey Beige
GREYBBASEFRAMEUX



RAL7006
Earth Clay
EARTHBASEFRAMEUX

* Our UX wooden covers are made of thermotreated poplar wood that has not been treated for colour stability. The wood will weather with outdoor exposure and turn grey.

VERSA PX

PRICE PX frame + canopy + support + protection cover			
	(1)	Concrete anchorage incl. (2) INGROUNDANCHORTYPE1	Mobile base incl. (3)
Versa PX	€ 4.091	€ 4.257	€ 5.314

Prices for replacement canopies, see UX collection.
Price for the protection cover, see UX collection.

HOW TO ORDER?

Choose a frame, a canopy and the two parts of the parasol base.

Example:

VEFRAMEBLACK_UX
+ VE300COVERSAND_UX_R
+ WOODBASETOPPLATEUX
+ BLACBASEFRAMEUX

= 1 PRICE FOR ALL PX MODELS
WITH PARASOL BASE

= € 5.314



VERSA UX/PX

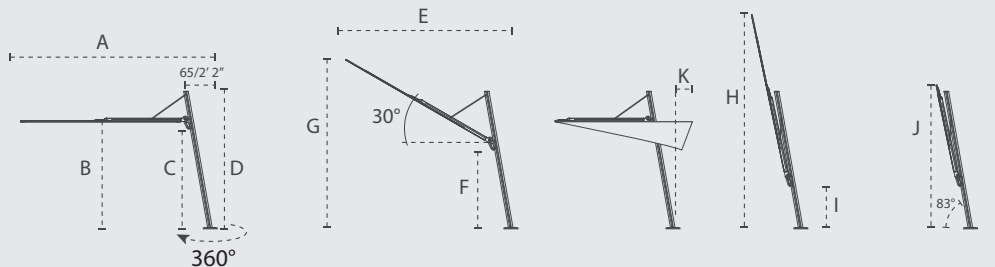

SQUARE

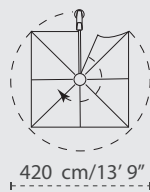

ROUND



POLE

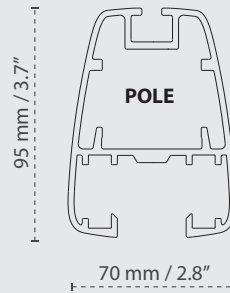

ARM

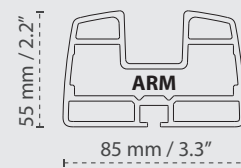

	A	B	C	D	E	F	G	H	I	J	K
	cm/ft	cm/ft	cm/ft	cm/ft	cm/ft	cm/ft	cm/ft	cm/ft	cm/ft	cm/ft	cm/ft
⊗ 3 x 3 m / 9' 10" x 9' 10"	365/11' 12"	195/6' 5"	185/6' 1"	260/8' 6"	280/9' 2"	128/4' 2"	325/10' 8"	410/13' 5"	77/2' 6"	265/8' 8"	0/0"
⊗ 3,5 m / 11' 6"	380/12' 6"	195/6' 5"	185/6' 1"	260/8' 6"	295/9' 8"	128/4' 2"	340/11' 2"	425/13' 11"	77/2' 6"	280/9' 2"	0/0"

Attention: To reduce its ecological footprint, Umbrosa no longer includes the tiles with the bases. We recommend our customers to source those locally.

TILEBASE = frame + cover + wheels – tiles not included

(1) Fixation on hard ground

(2) Fixation in soft ground

(3) Use on mobile parasol base

For easy mounting, order spacer in addition!

ECLIPSUM

CONCEPT



A parasol doesn't get any rounder than the Eclipsium UX by Umbrosa. The new Eclipsium UX may look the same as its predecessor, but you'd be surprised. The parasol has been reinforced on several levels: wind resistance, stronger glass fibres and better rotation axis.

DESIGNER

NG Design

USP

The only truly round parasol: an iconic shade object.

SELLING TIPS

- Very easy to use
- Pole and ring rotate 360°
- Unique eye catcher on your terrace
- Canopy is easy to install and to store

VERSIONS

ECLIPSUM UX



FULL BLACK

From € 4.636

Ø 3 m



ARCHITECTURE

From € 4.636

Ø 3 m



KARIM RASHID

From € 5.285

Ø 3 m

ECLIPSUM PX

NEW



ECLIPSUM PX

From € 4.886

Eclipsum PX freely combinable: 1 size, 2 frame colours, 8 fabric colours

FRAME COLOURS

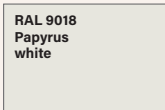

**RAL 9018
Papyrus
white**

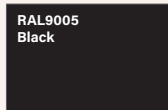

**RAL 9005
Black**

CANOPY COLOURS

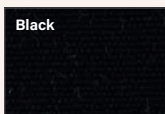

Black



Marble

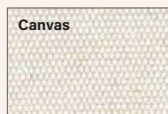

Canvas

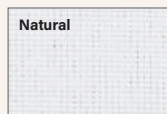

Natural



Flanelle

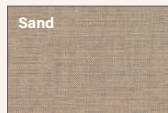

Sand

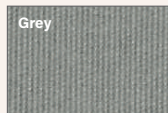

Grey



Taupe





ECLIPSUM UX

Production lead time: 3 weeks

PRICE frame + canopy + support + protection cover					
	Dimension	(1)	Concrete anchorage incl. (2) INGROUNDANCHORTYPE1	Mobile UX base incl. (3)	
ECLIPSUMNARCHI_UX	Ø 3m	€ 4.636	€ 4.801	€ 5.859	TILEBASEUX-ARCHI
ECLIPSUMNBLACK_UX	Ø 3m				TILEBASEUX-L-BLACK
ECLIPSUM2N-KRASHID	Ø 3m	€ 5.285	€ 5.450	€ 6.678	TILEBASEUX-L-KRASHID

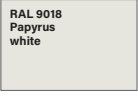
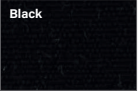
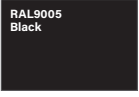
UX combinations Eclisum

Material		Material		Material	
Canopy	Frame + Base	Canopy	Frame + Base	Canopy	Frame + Base
					
ARCHITECTURE		FULL BLACK		KARIM RASHID	

REPLACEMENT CANOPIES

	Description	Price VAT excl.
ECLIPSUMCOVERN-BLACK	3 m Black	€ 826
ECLIPSUMCOVERN-MARBL	3 m Marble	
ECLIPSUMCOVN-KRASHID	3 m unique design Karim Rashid	€ 1.126

PROTECTION COVER

	Description	Price VAT excl.
ECPROTECTION_UX	Cover bag Flanelle with fiberglass stick.	€ 243

(1) Fixation on hard ground





(2) Fixation in soft ground

(3) Use on mobile parasol base

For easy mounting, order spacer in addition!

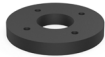
ECLIPSUM UX

MOUNTING OPTIONS AND BASES

		Description	Finish	Price VAT excl.
Hard ground		When you want to install the umbrella on a solid surface, it is recommended to order a spacer so that you don't have to make a cutout in the surface.	HDPE	€ 63
SPACER1				
Soft ground		Concrete anchorage to install the pole in a "soft" ground pouring concrete. To use in combination with a round support.	Galvanized steel	€ 165
INGROUNDANCHORTYPE1				
Mobile bases		Mobile large UX base set: base - cover - wheels - 32 kg - 88,8 x 88,8 x 22 cm. Tiles not included.	Black - RAL 9005	€ 1.223
TILEBASEUX-L-BLACK			Papyrus White - RAL 9018	
TILEBASEUX-L-ARCHI			Telemagenta - RAL 4010	
TILEBASEUX-L-KRASHID				€ 1.393
TILESET2N		Set of 12 concrete tiles, required for the large UX tile base. 4 tiles will need a corner to be cut out (see installation manual).		€ 238



ECLIPSUM PX

CHOOSE YOUR COMBINATION

1. FRAME COLOUR



ECFRAMEPAPY_UX



ECFRAMEBLACK_UX

2. CANOPY COLOUR

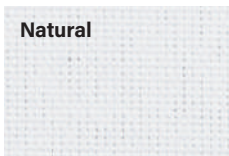

ECLIPSUMCOVERN-NATUR

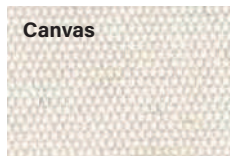

ECLIPSUMCOVERN-CANV

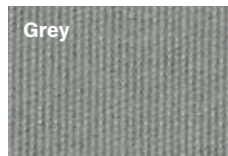

ECLIPSUMCOVERN-GREY



ECLIPSUMCOVERN-TAUPE

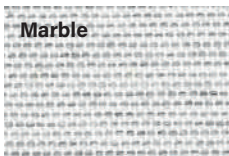

ECLIPSUMCOVERN-MARBL

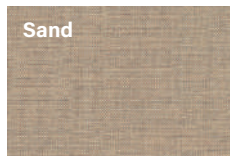

ECLIPSUMCOVERN-SAND

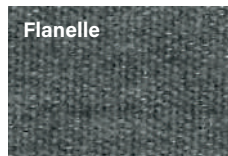

ECLIPSUMCOVERN-FLANE

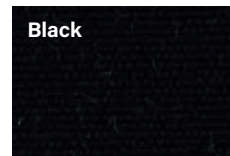

ECLIPSUMCOVERN-BLACK

3. BASE

A. Top plate



RAL9018
Papyrus white
PAPYBASETOPPLATEUX

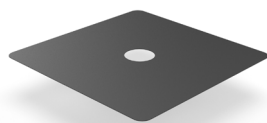

RAL9005
Black
BLACBASETOPPLATEUX



Thermo
Poplar*
WOODBASETOPPLATEUX

B. Frame base



RAL 9018
Papyrus white
PAPYBASEFRAMEUX



RAL9005
Black
BLACBASEFRAMEUX

* Our UX wooden covers are made of thermotreated poplar wood that has not been treated for colour stability. The wood will weather with outdoor exposure and turn grey.

ECLIPSUM PX

PRICE PX frame + canopy + support + protection cover			
	(1)	Concrete anchorage incl. (2) INGROUNDANCHORTYPE1	Mobile base incl. (3)
Eclisum PX	€ 4.886	€ 5.051	€ 6.109

Prices for replacement canopies, see UX collection.
Price for the protection cover, see UX collection.

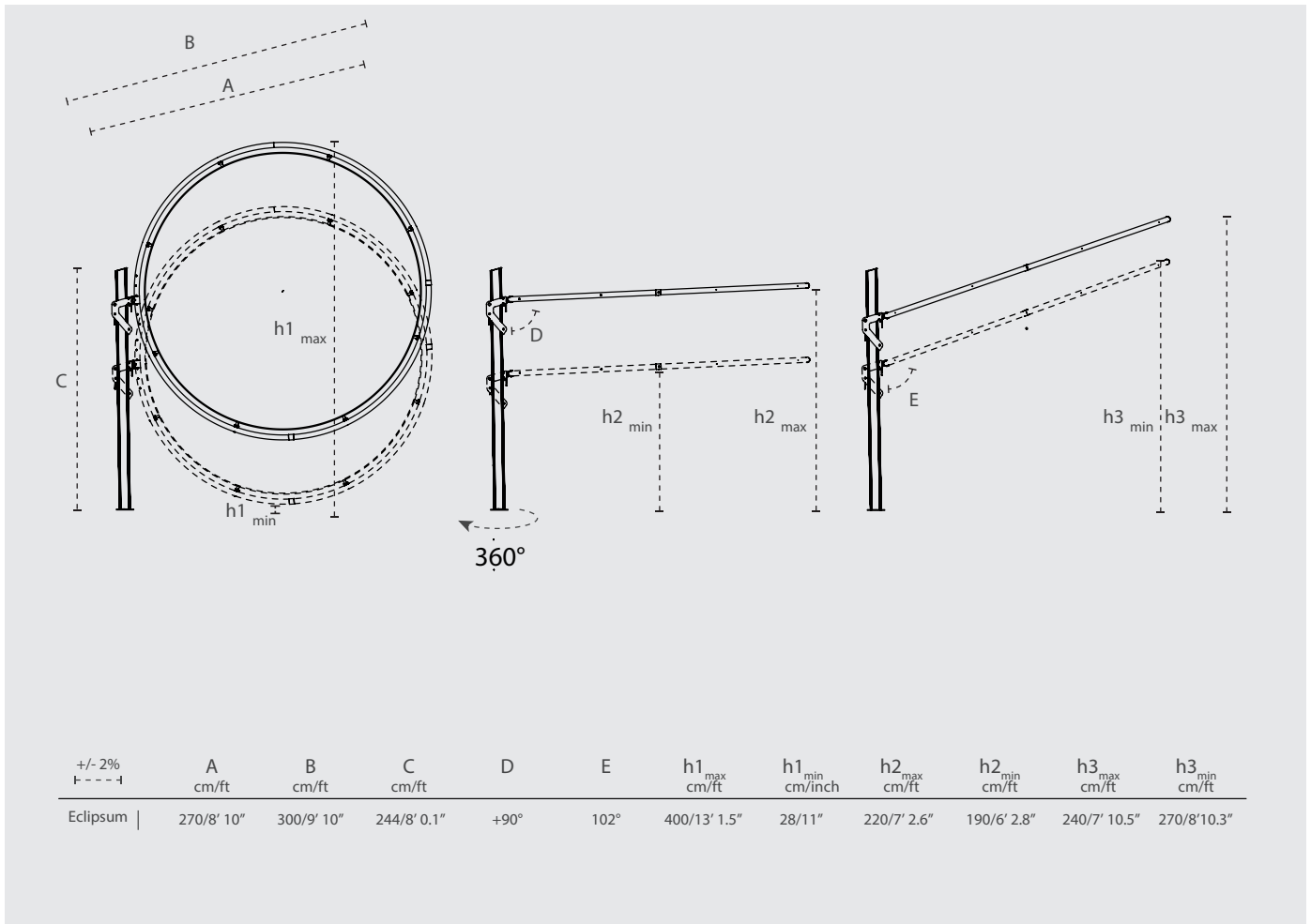

Attention: To reduce its ecological footprint, Umbrosa no longer includes the tiles with the bases. We recommend our customers to source those locally.
TILEBASE = frame + cover + wheels - tiles not included

(1) Fixation on hard ground (2) Fixation in soft ground (3) Use on mobile parasol base
For easy mounting, order spacer in addition!

USE

Umbrosa always adheres to the warranty obligations of Belgian and European manufacturers in accordance with the law. All warranty requests must be submitted out via the trader or website where the product was purchased. Umbrosa strives to develop and produce **high-end, high-quality, and sustainable products**. Products that are optimized to withstand weather conditions and the environment in which they are used. All Umbrosa products are **extensively tested to guarantee their quality**. This includes tests conducted at the University of Delft (NL) wind tunnel, and component testing with independent research laboratories. In case of damage, the Umbrosa products can be repaired. A **comprehensive after-sales department** has been put in place to this end. The biggest threat to the lifespan of an Umbrosa umbrella are the weather conditions and external environmental factors. Therefore, always provide the appropriate care for any Umbrosa product and never leave it open unattended. Damage caused by incorrect use or extreme weather conditions such as wind, snow, hail, storm, ... is excluded from the warranty. **Wind tunnel tests** with permanent fixation of the umbrella have shown that Umbrosa products can withstand wind speeds of over **40 km/hour (5 Beaufort)**. Damage caused at unattended moments or by poor fixation or use of weak supports are not covered by our warranty programme. As wind does not have a constant speed, and as gusts of wind are often more powerful than imagined, we advise to close the umbrella at all times whenever wind speeds exceed 30 km/hour (4 Beaufort). When closing the umbrella the strap and protection cover need to be correctly used. Failure in doing so can cause damage even in a closed position. This kind of damage is not covered by our warranty programme. The use of mobile or movable base has an impact on the wind resistance of the umbrella. Therefore, always select the heaviest available base to enhance security. Always contact the distributor or Umbrosa should you desire advice on the anchoring method to be used. www.umbrosa.com contains a large amount of information on this topic. Direct and indirect damage caused by a falling umbrella, whether it is in open or closed position, is not covered by the warranty. Tests conducted by independent laboratories have demonstrated that the corrosion resistance of Umbrosa products is better than normal. With intensive usage of the products in a hostile (sea, sand, chlorine, ...) environment, we advise that you regularly rinse the frame and canopy of the umbrella using fresh water in order to prevent the build-up of salt residue. You can purchase these from Umbrosa. Use of the warranty always requires the presentation of the original purchase invoice. Umbrosa also makes use of serial numbers. This number must always be stated with every warranty request. www.umbrosa.com offers a complaint form with clear specifications of the information necessary to process the warranty request efficiently and quickly. Warranty requests must always be submitted in writing within a reasonable term after the initial observation of the issue. Umbrosa guarantees that the problem will be solved, **be it through replacement, repair, or a custom solution**. The warranty is always extended with the duration of "non-usage". The warranty does not restart in case of replacement with a new product. Transportation and performance of the repairs are not borne by Umbrosa. The Umbrosa guarantee only applies if the product was installed in accordance with the Umbrosa installation manual. The warranty shall completely lapse in case of use of accessories not approved by Umbrosa.

SPECIAL WARRANTY PROVISIONS "HARDWARE" :

15-year warranty**

Umbrosa offers a 15-year warranty on all aluminum extrusion profiles. This warranty only covers damage caused by construction or manufacturing errors, scratches, superficial corrosion, and wear due to use are not covered by this warranty unless the product is structurally weakened as a result.

5-year warranty*

Umbrosa offers a 5-year warranty on all glass fiber ribs and all welded tubes. Umbrosa offers a 5-year warranty on all stainless steel. Scratches, superficial corrosion, and wear due to use are not covered by this warranty unless the product is structurally weakened as a result.

3-year warranty*

Umbrosa offers a 3-year warranty on all synthetic parts and all galvanized steel parts. Scratches and wear due to use are not covered by this warranty unless the product is structurally weakened as a result.

2-year warranty*

Umbrosa offers a 2-year warranty on granite base, tile base, and mobile concrete base. Scratches, superficial corrosion, and wear due to use are not covered by this warranty. Breakage of the concrete or granite base due to use in case of strong wind is not covered under this warranty. In case of breakage, the new replacement concrete part may show a difference in colour, this is unavoidable. Umbrosa offers a 2-year warranty on all painted parts. Whenever the paint flakes off or forms bubbles, Umbrosa will replace the damaged item, or present a custom solution.

Caution:

Umbrosa uses natural products or materials (wood, concrete, granite, ...) that are susceptible to weather conditions and thus naturally age. The natural ageing process in outdoor conditions is not covered by warranty. Likewise, Umbrosa cannot guarantee that its products will be free from stains due to animal excrement and/or pollution phenomena.

(*) Warranty is only applicable when the Umbrosa products are used under normal wind conditions and when they are thoroughly and regularly maintained as described in the manual under chapter 'do's and don't's'. Direct or indirect damage caused by incorrect use or wrong installation are not covered by the warranty.

WARRANTY

SPECIAL WARRANTY PROVISIONS "FABRICS & TEXTILE PREFABRICATION" :

Extensive research, testing and years of experience have proven fabrics in acrylic to be the best fabric for use on the Umbrosa products.

5 year warranty (except for Ingenua and protection covers) **

All fabrics in all collections, with the explicit exception of the Ingenua collection, a 5-year warranty is offered for discolouration and structural integrity. In the exceptional case of discolouration, Umbrosa will lay out a compensation proposal proportional to the usage period of the product, or a choice will be offered to receive a new canopy whereby the cost for cutting & prefabrication will be charged. Under no circumstances will discolouration result in the free delivery of a new canopy. Burn holes, melted holes, or fabric deformation are therefore not covered by the warranty since these are caused by inappropriate use of the umbrosa products. Daily protection of the umbrella using the protection cover enhances the lifespan of the umbrella exponentially.

2 or 3 year warranty for the Ingenua sails ()**

For no other product is usage intensity as well as exposure to UV so different from user to user. Due to the intensive usage of Ingenua sails, very specific warranty conditions apply to this collection.

The warranty on these sails covers discolouration and structural integrity. For continental Europe, this warranty is 3 years. In the exceptional case of discolouration, Umbrosa will lay out a compensation proposal proportional to the usage period of the product, or a choice will be offered to receive a new canopy whereby the cost for cutting & prefabrication will be charged. Under no circumstances will discolouration result in the free delivery of a new canopy. Outside of continental Europe, the warranty is 2 years. Research does show that the expected lifespan is 5 to 8 years under normal usage, i.e. with daily covering of the sail using the appropriate protection cover and storing it in a dry place.

Special warranty conditions - Zippers

Zippers are very susceptible to correct usage. The risk of breakage increases exponentially in case of inappropriate usage of the zipper. Therefore, study the usage instructions very closely if the selected product has a zipper. If the zipper is stiff, this issue can quickly be resolved using a silicone spray or another lubricant (no oil!).

In case of zipper breakage, Umbrosa can send a replacement zipper.

LEGAL WARRANTY ON PROTECTION COVERS :

Protection covers are covered by the legal warranty.

PRICES AND DIMENSIONS

- Prices are subject to change. The prices are the basis for the discount that applies to you. So please always contact us to be sure you have the most recent pricelist. Do not hesitate to contact us if you would like to receive a specific quotation for larger quantities or for a specific project.
- The dimensions listed in this pricelist may vary with +/-2%, we are not responsible for any discrepancies within this margin. If a dimension is of extreme importance, please do not hesitate to contact Umbrosa to ask for the latest drawing.
- Items not mentioned in this price list are only available under certain conditions. For more details, contact Umbrosa.

NICE TO KNOW

UV rays have an impact on all substances and materials that are used outside. On the one hand we can speak about the 'discolouration' of the fabrics and on the other hand also about 'weakening'. Both can affect life expectancy. In addition, UV rays also have a detrimental effect on people. The UV rays can cause skin irritation, skin aging and skin cancer. To prevent these effects of UV rays, Umbrosa is using high quality fabrics and materials which have a proven colour fastness and offer the necessary protection against the sun. Umbrosa guarantees you products that will bring you years of joy.

(**) Warranty is only valid if the user does not make any changes to the specified sail systems and accessories. Umbrosa products are used under normal wind conditions and are well and regularly maintained. Damage caused by friction or water collection are not covered by the warranty. This must be avoided at all times as described in the manual chapter 'Do's and Don't's'.

BEAUFORT SCALE

BEAUFORT N°	DESCRIPTION	KM/U	MPH	EFFECTS OBSERVED ON LAND
1	Light air	1-5	1-3	Direction of wind shown by smoke drift.
2	Light breeze	6-11	4-6	Wind felt on face, leaves rustle.
3	Gentle breeze	12-19	7-10	Leaves and small twigs in constant motion, wind extends light flag.
4	Moderate breeze	20-28	11-16	Raises dust and loose paper, small branches are moved.
5	Fresh breeze	29-38	17-21	Small trees in leaf begin to sway, crested wavelets form on inland waters.
6	Strong breeze	39-49	22-27	Large branches in motion, umbrellas used with difficulty.
7	Near gale	50-61	28-33	Whole trees in motion, inconvenience felt in walking against the wind.
8	Gale	62-74	34-40	Breaks twigs of trees.
9	Strong gale	75-88	41-47	Slight structural damage occurs (chimney pots and slate removed).
10	Storm	89-102	48-55	Trees uprooted, considerable structural damage occurs.

PRODUCT STRENGTH ACCORDING TO THE BEAUFORT SCALE*

PRODUCT	BFT SCORE	PRODUCT	BFT SCORE
PARAFLEX / PARAFLEX UX/PX	3 - 6	INGENUA	4 - 8
SPECTRA / VERSA UX/PX	4 - 7	ECLIPSUM UX/PX	5 - 6
NATA / NATA UX	5 - 6	ICARUS / ICARUS UX/PX	5 - 9

* The wind scores are valid for a parasol placed on the ground floor. For installation of a parasol on another, higher floor, contact Umbrosa for the best possible solution.

TIPS FOR THE IDEAL WIND POSITION

NATA / NATA UX

For Nata, we advise to avoid wind from below (1), to fully open the canopy and put the umbrella on a flat surface. When closing the umbrella the strap needs to be correctly used. Failure in doing so can cause damage even in a closed position.

PARAFLEX / PARAFLEX UX / PARAFLEX PX

For Paraflex (UX/PX) we advise to position the arm following the direction of the wind (1), completely stretch out the arm (2), place the grip in between the ribs (3), put the umbrella horizontally (4) and on a flat surface.

SPECTRA / VERSA UX / VERSA PX

For Spectra, Versa (UX/PX), we advise to position the umbrella in the direction of the wind (1), put the arm in a 10° angle (2) and put the umbrella on a flat surface.

ICARUS / ICARUS UX / ICARUS PX

For Icarus (UX/PX), we advise to position the umbrella in the direction of the wind (1), put the umbrella in a slight upward position (2) and put it on a flat surface.

ECLIPSUM UX / ECLIPSUM PX

For Eclisum (UX/PX), we advise to position the umbrella in the direction of the wind (1), put the circle under a slight angle (2) and put it on a flat surface.

INGENUA

For Ingenua, we advise you to put the sail in a angled position to prevent wind from getting under the sail (1); to put full tension on the sail only by using the Umbrosa ropes and dogbones (2) and to install the poles in a backward position (3).

GENERAL

When closing the umbrella, the strap and protection cover need to be correctly used. Failure in doing so can cause damage, even in a closed position.

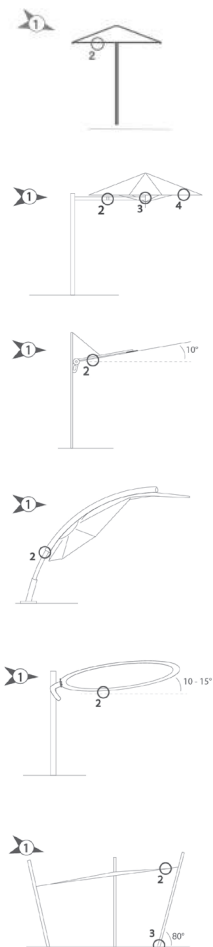

UMBROSA

UNIQUE SHADE DESIGN

ELMINA.
mój životný štýl

ELMINA Bratislava | OC LIGHTPARK | Račianska 90 | Bratislava
www.elmina.sk | elmina@elmina.sk | +421 910 919 711
CENY BEZ DPH